



# Owner's Manual

## *prodigy 5*<sup>®</sup>

### 5 Star Gas Hot Water Heater

Models: 135D5N, 135D5L,  
170D5N, 170D5L



Installation Details

Owner's Information

Warranty

For advice, repairs and service, call:

1300 365 115 (Australia)

0800 729 389 (New Zealand)



Carefully remove all packaging and transit protection from the heater before installation. Dispose of the packaging responsibly using re-cycling facilities where they exist.

Specifications and materials may change without notice.  
Effective for all Prodigy 5 water heaters manufactured and sold after 1st January 2013.



# Contents

Welcome To Dux Hot Water	1
Installation Details	2
Plumbing Connections	3
Specifications	6
Gas Connections	7
Commissioning Adjustments	8
Owner's Information	12
System Maintenance	14
Troubleshooting	15
Warranty	17
Other Information	22



Owner's Manual – Prodigy 5

## Welcome To Dux Hot Water

Your decision to purchase a Dux Hot Water system will reward you for many years to come.

Since 1915, the Dux range has seen continuous research and development, resulting in many breakthroughs in the efficiency, reliability and longevity of hot water systems.

Dux water heaters are manufactured in Australia in a state-of-the-art facility, using a Quality Endorsed Company production system.

This is your assurance that you have purchased the highest quality water heater available, one that will provide continuous hot water for all your needs – safely, economically, and for many years to come.

To be upfront about it, we want Dux to be your brand of choice. So you can depend on us to provide more than just a hot water system.

You can rely on Dux products and choose them with confidence. We'll make sure you have the information, the quality and the innovation you're looking for, including the latest energy-saving alternatives. If you should ever have a problem – and we'll bet you won't – you'll find that we're easy to get hold of, friendly to talk to and quick to act. Our service is all about providing anything you need as soon as you need it.

Go with Dux and you'll have a dependable, economical, efficient hot water system designed to perform well, year after year. And that's a promise.





## Installation Details

### Outdoor Tank Installation

The water heater must be installed outdoors, with the minimum clearances as shown in the figure below.

**We recommend a plinth be installed under the water heater where the water heater is subjected to wet conditions.**

Minimum clearance around the windows and doors must be maintained – refer to AS 5601.

### Location

The water heater should be located as close as possible to the most frequently used hot water outlet. Ensure that the data label is clearly visible and that there is adequate access for servicing the unit.

**Note:** All models are equipped with a sacrificial anode, accessible through the top cover. Allow 50% of the height of the water heater for clearance above to replace the anode.

A properly drained overflow tray must be used where property damage could occur from water spillage. (See AS/NZS3500.4 for further details). Warranty does not cover consequential damage due to heater leakage.

### Safety

This appliance is not intended for use by persons (including children) with reduced physical, sensory or mental capabilities, or lack of experience and knowledge, unless they have been given supervision or instruction concerning use of the appliance by a person responsible for their safety.

Children and animals should be supervised to ensure that they do not interfere with the appliance.

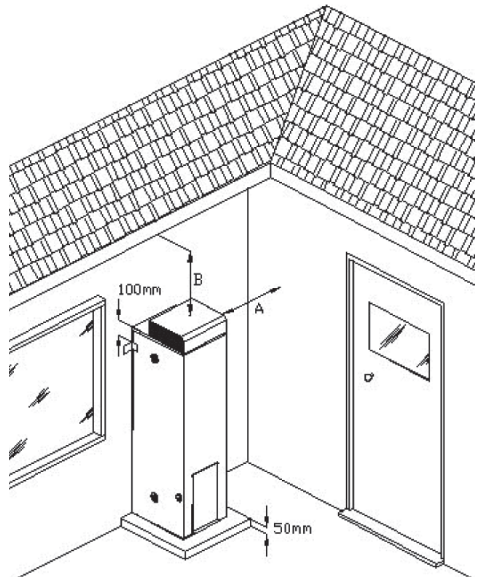

A = 500mm B=300mm min  
For further details, refer to  
AS 5601 – Gas Installation Code



# Plumbing Connections

## Installation Requirements

This water heater must be installed by a licensed tradesperson, and in accordance with:

- AS/NZS3500.4 “National Plumbing and Drainage Code Hot Water Supply Systems – Acceptable Solutions”.
- AS5601/AG601 “Gas Installations”.
- Local authority regulations.
- Outside Australia and New Zealand, please refer to local plumbing and building codes and regulations.
- Notice to Victorian customers from the Victorian Plumbing Industry Commission – this water heater must be installed by a licensed person as required by the *Victorian Building Act* (1993). Only a licensed person will give you a compliance certificate, showing that the work complies with all the relevant Standards and only a licensed person will have insurance protecting their workmanship for 6 years.

## Water Supply Pressure

This water heater is designed for direct connection to water supply pressures of no greater than:

### All Litre Models – 1120kPa

Where the mains pressure can exceed or fluctuate beyond the pressure shown above a pressure limiting device (complying with AS1357) must be fitted in the cold water inlet supply. This device must be installed after the isolating valve and set below the pressure shown above. Note during periods of lower demand water pressure may increase.

## Pool Heating

This water heater must **not** be used for pool heating.



# Plumbing Connections

## Pressure & Temperature Relief Valve

The Pressure & Temperature Relief Valve is supplied loose with the water heater. The valve rating is:

### All Models – 1400kPa

The PTR valve must be installed directly into the top socket marked “RELIEF VALVE”. The drain line from this valve must run in a continuously downward direction in a frost-free ambient position with the discharge end left open to atmosphere permanently.

The PTR Valve is not intended to enable connection of the water heater to supplementary energy sources such as solar panels or slow combustion stoves (refer AS/NZS 3500.4 for guidance on these types of installations).

Open the PTR Valve for approximately 10 seconds by lifting the lever on the valve to ensure water is relieved to waste through the relief drain pipe. Lower lever gently and check that it closes correctly.

**Warning:** We recommend that you open the PTR valve at least once every six (6) months. Failure to do this may result in problems with the water heater.

The PTR Valve must not be tampered with or removed. The water heater must not be operated unless this valve is fitted and in working order.

The PTR Valve should be checked for adequate performance or replaced at

intervals not exceeding 5 years, or less in areas where local regulations apply.

**Important:** The PTR Valve and its drain outlet pipe must not be sealed or blocked. It is normal for the PTR valve to leak a small amount of water during heating cycles.

## Cold Water Connection

It is mandatory to fit the following items between the supply main and the RP $\frac{3}{4}$ "/20mm socket in the water heater.

- an isolating valve
- a non return valve
- a line strainer
- a union

All fittings must be approved by the relevant Authority and in accordance to the plumbing code.

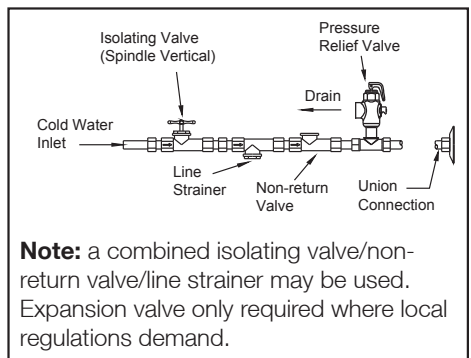

**Note:** a combined isolating valve/non-return valve/line strainer may be used. Expansion valve only required where local regulations demand.



## Plumbing Connections

**Note for S.A. and W.A.:** It is a state requirement that a pressure relief valve be fitted on the cold water supply line between the non return valve and the water heater.

### Hot Water Connection

The hot water line should be connected to the "OUTLET" socket on the tank.

### Insulation of Pipes

All hot water pipes **must** be insulated with UV stabilized insulation.

### Temperature Protection

All water heaters have the ability to produce hot water very quickly. To reduce the risk of scald injury, it is mandatory under the requirements of Australian Standard AS/NZS3500.4 that a suitably approved temperature control device, such as a tempering valve, be fitted to the hot water supply to outlets used primarily for personal hygiene.



# Specifications

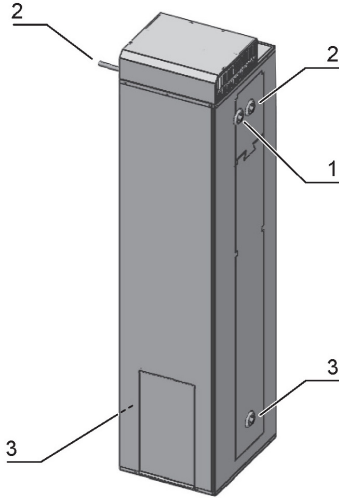

System Components	
Component	Description
1	PTR Valve
2	Hot Water Outlet To House
3	Cold Water Inlet

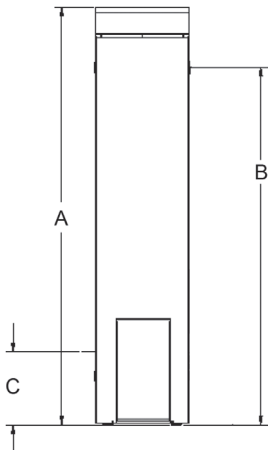
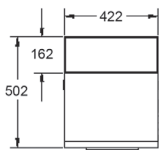

## Tank Specifications

Model Numbers	135D5N, 135D5L	170D5N, 170D5L
Capacity (L)	135	170
Net Weight Empty (kg)	76	88
Relief Valve Pressure (kPA)	1400	1400
Gas Consumption (Propane)	22.5 MJ/h	26 MJ/h
Gas Consumption (NG)	23.5 MJ/h	27 MJ/h

## Dimensions (mm)

A – Height	1610	1910
B – Hot Water Outlet	1320	1620
C – Cold Water Inlet	220	220





## Gas Connections

Refer to the Data Label for correct gas type. Gas piping should be connected through the side of the case (see figure below).

The plastic grommet must be installed around the pipe and clipped into the case.

The gas control is fitted with a RC $\frac{1}{2}$ "/15 socket. A union connection should be used.

Gas pipe sizes should be in accordance with AS5601/AG601.

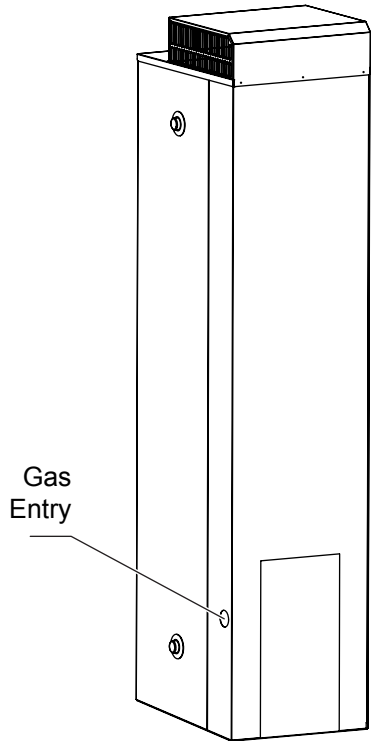



## Commissioning Adjustments

**Note: Commissioning adjustments can be done only by a licensed tradesperson.**

### Lighting the Water Heater

The water heater must be filled with water before lighting. Instructions for lighting procedure are on the inside of the access cover and shown below:

1. Turn the knob fully clockwise to the “●” (off) position.
2. Wait five (5) minutes so any build-up of unburnt gas can escape.
3. Turn the knob to the ★ (pilot) position.

Thermostat and  
gas control knob

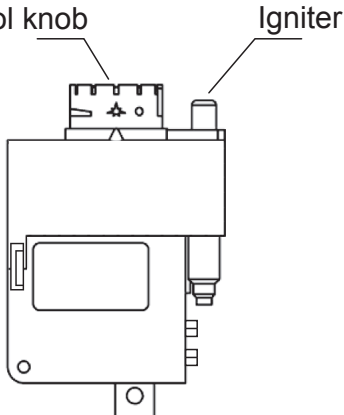

4. Depress the knob fully (until ★ disappears below housing) and after thirty (30) seconds, whilst keeping the knob depressed, repeatedly press the igniter button (for up to 40 seconds) until the pilot flame ignites.  
**Note:** It is not possible to depress the knob fully if the gas control has activated its safety shut-off feature. In this case, wait 60 seconds for the gas control to reset.
5. Keep the knob depressed for twenty (20) seconds after the pilot flame lights. The pilot flame can be observed if a mirror is placed directly below the pilot assembly.
6. Release the knob and check if the pilot is still alight.
7. If pilot has failed to light or has not remained alight, turn gas control knob to “●” (off). Wait five (5) minutes for the escape of unburnt gas, then begin again at step 3.
8. When the pilot flame remains alight with the knob released, turn the knob anticlockwise to one of the number settings. A setting of “6” is recommended and this will give a water temperature of about 60°C.



## Commissioning Adjustments

9. Turn the knob to a higher number for higher water temperatures or a lower number for lower water temperatures.
10. Set the test point pressure as per page 12.
11. Replace the access panel and ensure that it is firmly in position before operating the appliance.
12. If the burner does not light at the selected setting, the water may already be at the selected temperature.

**Warning:** Do not attempt to light if the pilot is out and the knob is in the "ON" position (one of the number settings). Follow steps above.

### Shutting Down The Water Heater

1. Turn the knob to "•" (off) position.
2. Turn water off at water isolating valve.

### Turning Off Gas To The Appliance

1. Turn the knob to "•" (off) position.
2. Turn off the gas isolation valve.

To maintain safety and efficiency this heater should be serviced annually by an authorised service agent.



# Commissioning Adjustments

## Main Gas Pressure Regulator Adjustment

The main burner pressure must be set at installation.

The pressure is best checked by connecting a water manometer or equivalent to the test point nipple on the gas relay valve. **The test point pressure must comply with the value on the Data Label.**

A 2.5mm Hexagon (Allen) Key is required to remove the screw from the test point nipple.

If adjustment is necessary, proceed as follows:

1. Remove the securing screw (1) from the top of the Gas Control and lift the plastic cover (2) upwards.
2. Locate the regulator adjustment screw on the lower left hand side of the Gas Control (3).
3. Light the burner. Rotate adjustment screw clockwise to increase, or anti-clockwise to decrease pressure.
4. Replace the plastic cover and securing screw.

**Note:** Pressure adjustments at gas cylinder regulator should be conducted as required to ensure correct supply pressure to water heater as per AS5601/AG601.

## Ignition System (Spark Gap)

If there is no spark or the spark looks weak, adjust as follows:

1. Check the gap between the spark electrode and the pilot burner is 3 – 5mm and adjust as necessary.
2. Push the igniter button to test for a spark.

**Warning:** Test the spark gap only where there is no build up of gas.

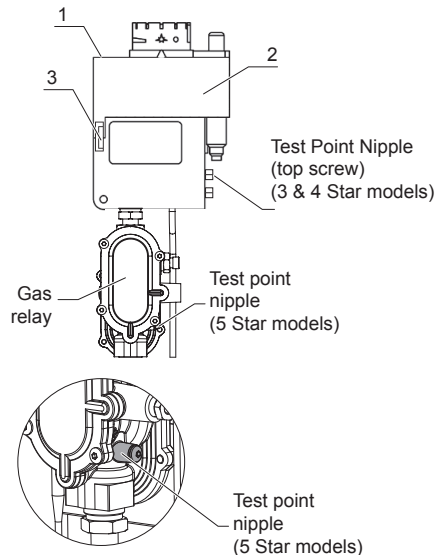



## Commissioning Adjustments

### Gas Fitter – Test The Water Heater

Test operation by lighting the water heater (see **Lighting the Water Heater**, earlier in this manual).

**Warning:** This water heater should be checked on installation and the test point pressure set in accordance with that marked on Data Plate.

Adjust gas pressure as required to achieve specified gas test point pressure. If problems are encountered in this process contact the Dux Service Department.

Failure to accurately set the pressure can result in damage to the water heater, and automatically cancels the Manufacturer's Warranty. This water heater is to be installed only by an Authorised Person.

**Note:** Instruct owner in water heater operation before leaving.

### User

**DO NOT** place articles on or against this appliance.

**DO NOT** use store chemicals or flammable materials, or spray aerosols near this appliance.

**DO NOT** operate with panels or covers removed from the appliance.



## Owner's Information

### Operating Instructions

**The appliance is not intended for use by young children or infirm persons without supervision. Young children should be supervised to ensure that they do not play with the appliance.**

**Warning:** it is essential for the safe operation of this gas heater that clothing or any other flammable material should not be placed against or on top of the water heater. In addition, do not store flammable or corrosive materials, such as dry cleaning fluids, pool chemicals, etc., in close proximity to the heater.

The use of aerosol sprays in the vicinity of the heater should be avoided. The propellant gases used in these devices, e.g. fly-spray, hair-spray and laundry aids, can break down in the flames of the burner and produce corrosive agents.

**Caution:** If the water heater is left in an operating condition and unused for two weeks or more, a quantity of hydrogen (which is highly flammable) may accumulate in the top of the water cylinder. To dissipate this gas safely it is recommended that a hot tap be turned on for several minutes at a sink, basin or bath, but not a dishwasher, clothes washer or other appliance. During this procedure there must be no smoking, open flame or any other electrical appliance operating nearby. If hydrogen is discharged through the tap it will probably make an unusual sound as with air escaping.

### Water Quality

Your Dux water heater has been manufactured to suit water conditions of most Australian metropolitan supplies. Please note that harsh water supplies can have a detrimental effect on the water heater and its life expectancy. If you are unsure about your water quality you can obtain information from your local water supply authority.

The water heater is designed for use in areas where the Total Dissolved Solids (TDS) content of the water supply is less than 2500 mg/L. In areas where the TDS exceeds 600mg/L the magnesium alloy anode (supplied in the heater) may become over reactive. To alleviate this, the anode should be replaced with an aluminium alloy anode, available from your local Dux supplier.

Water can also be very corrosive, measured by the saturation index. If the water saturation index is greater than 0.40 an expansion control valve should be fitted and where the index is greater than 0.80 the water heater installed should be a Hard Water Model. Please consult our Service Department for advice if required.



## Owner's Information

### How Long Will The Heater Run Each Day?

The length of time that the heater will run each day will vary dependent upon the amount of hot water being used by the household.

**Caution:** All water heaters have the ability to produce hot water in a surprisingly short time. To reduce the risk of scald injury, it is mandatory under the requirements of Australian Standards AS3500 that an Australian Standards approved temperature control valve be fitted to the hot water supply pipe work. This valve should be checked at regular intervals to ensure its operation and settings remain correct.

### What Should I Do During Holidays?

If the hot water system is not used, for two weeks or more, a quantity of hydrogen gas, which is highly flammable, may accumulate in the water heater. To dissipate this gas safely, it is recommended that a hot tap be turned on for several minutes at a sink, basin or bath but not a dishwasher, clothes washer, or other appliance. During this procedure there must be no smoking, open flame or any other electrical appliance operating nearby. If hydrogen is discharged through the tap, it will probably make an unusual noise similar to air escaping.

**Note:** Important there are no user serviceable components in the system. Only an authorised service

representative is permitted to remove any covers or make setting adjustments. Do not open or adjust any electrical covers or devices yourself.

### How Does My System Work?

The Dux water storage tank is used to store the heated water ready for household use. It has a high temperature vitreous enamel lining to provide long life, and a high density polyurethane insulation to ensure minimal heat loss.

**Never turn the gas supply off during normal use.**



## System Maintenance

This Dux water heater is designed such that there is little to do regarding system maintenance other than that detailed in this *Owner's Manual*.

Personally inspecting or servicing any part of the system is not recommended.

### Anodes

The recommended time after installation when the anode should be inspected by an authorised person is 5 years.

After each 5 years of operation you should contact the local service agent to replace all safety valves and anodes to ensure continued system life and operational safety. In locations where the water has a TDS greater than 600 ppm, this service is recommended each 3 years.

### Six Monthly Service – By Owner

Operate the Pressure & Temperature Relief Valve for approximately 10 seconds by operating the easing lever on the valve to ensure water is relieved to waste through the relief drain pipe. Check to ensure the valve closes correctly.

### Five Year Service – By Authorised Personnel Only

The five year service must be carried out by a licensed tradesperson. It is recommended that this service be carried out by your local Dux agent.

The service should include the following:

- Replace the Pressure & Temperature Relief Valve.
- Replace the anodes (in areas of harsh or adverse water conditions, a more frequent check of the anodes is recommended).
- Flush the water heater by doing the following:
  - i. Turn off gas and electricity supply.
  - ii. Turn off the cold water supply to the water heater at the isolating valve.
  - iii. Gently operate the easing lever on the Pressure & Temperature Relief Valve to release the pressure in the water heater.
  - iv. Disconnect the cold water inlet union to the heater and attach a drain hose.
  - v. Gently operate the Pressure & Temperature Relief Valve to let air into the heater and allow water to escape through the hose.
  - vi. Flush the heater until clear water appears then reconnect all fittings, fill the heater and restore the gas and electricity supply.





## Troubleshooting

### **What Should I Check Before Making A Service Call?**

If there is not enough hot water, it is recommended that the following points be considered before making a service call. If after checking the following points the problem has not been identified, please contact Dux on 1300 365 115.

### **No Hot Water**

- Is the Pressure & Temperature Relief Valve discharging too much water?
- Do you have the correct size water heater for your requirements? Sizing details are available from your Dux supplier.
- Is one outlet (such as the shower) using more hot water than you think?
- Carefully review the family's hot water usage and if necessary check the shower flow rates with a bucket, measuring the amount of water used over that period of time. If it is not possible to adjust water usage patterns, an inexpensive flow control valve can easily be fitted to the shower outlet.
- Consider that during night time heating, the time taken to heat the tank can take longer so you may find that the tank has not fully recovered from a period of heavy usage the previous evening.
- Consider that often the hot water usage of showers, washing machines and dishwashers can be under estimated. Review these appliances to determine if your daily usage is greater than the storage volume of your water heater. For example, if you have a 170 litre storage tank and you are using 300 litres of water it is possible that there will be certain times of the day where there is insufficient hot water. It is also advisable to inspect tap washers etc. for leakage and replace if necessary.
- Is there a leaking hot water pipe or dripping hot water tap? A small leak can waste a large quantity of hot water.
- Replace faulty tap washers and have your plumber rectify any leaking pipe work.



## Troubleshooting

### **Water Discharge From Pressure & Temperature Relief Valve (PTR)**

It is not unusual for a small quantity of water to discharge during the heating of water in your storage tank. The amount of discharge will depend on hot water usage and size of the storage tank.

As a guide, it will discharge 3% of the storage capacity of water in the heating period.

### **Continuous trickle (PTR)**

This is most likely due to a build up of foreign matter. In this case try gently raising the easing lever on the Pressure & Temperature Relief Valve for a few seconds then release gently. This may dislodge a small particle of foreign matter and rectify the fault.

### **Steady flow (PTR) – more than 20L per day**

This may be caused by excessive water supply pressure, a faulty Pressure & Temperature Relief Valve or a faulty thermostat. Turn off the electricity supply and contact your Dux Hot Water.



# Warranty

## Dux Hot Water Unit

### Manufactured by Dux Manufacturing Limited (“Dux”)

### Terms of Warranty and Replacement Guarantee

All Prodigy 5 water heaters manufactured and sold after 1 January 2012 are backed by a comprehensive one (1) year full parts and labour warranty (conditions apply – see below).

Furthermore, the Prodigy 5 tank includes a guarantee to replace your hot water unit if the inner cylinder fails within ten (10) years (conditions apply – see below).

The terms of the Warranty and replacement guarantee are set out below.

### 1 Year Comprehensive Warranty

Your hot water system and its components (“Unit”) are covered by 1 year (parts and labour) warranty against defective factory materials or workmanship.

This warranty period commences from the date of installation of the Unit providing you have proof of this installation date. Where the date of completion of installation is not known or cannot be proven, then this warranty will commence one (1) month after the date of manufacture (refer to the data label on the unit).

### 10 Year Replacement Guarantee

If an inner cylinder fails on a Dux hot water unit within a further nine (9) years after the end of the initial one (1) year warranty period, Dux will provide a free replacement hot water unit at the nearest approved Dux agent or Dux office to the owner's home. Under this replacement guarantee, the transport, installation and labour costs of delivering the replacement hot water unit and removing and replacing the existing hot water unit will be the responsibility of the owner of the existing hot water unit.

### Conditions of Warranty and Replacement Guarantee

The benefits provided to you by the warranty and replacement guarantee (collectively “Warranty”) are in addition to the guarantees and other rights and remedies available to you under the Australian Consumer Law (“ACL”).

If the Unit fails to conform to this Warranty during the applicable period, Dux will replace any failed component or where necessary, in the absolute discretion of Dux, replace the Unit free of charge including reasonable labour costs incurred in normal business working hours.

This Warranty only applies to defects which have arisen solely from faulty materials or workmanship in the Unit and does not apply to other defects which may have arisen as a result of, without limitation, the following:



## Warranty

accidental damage, abuse, misuse, maltreatment, abnormal stress or strain, harsh or adverse water conditions including excessive water pressure or temperature, neglect of any kind or otherwise as a result of any use of the Unit contrary to the product manual or other instructions provided by Dux. Alterations or repair of the Unit other than by an accredited and licensed service agent or technician are not covered. Attachment of accessories or use of non genuine replacement parts other than those manufactured or approved by Dux are not covered by this Warranty.

This Warranty applies only to the Unit and does not cover any ancillary plumbing or electrical parts supplied by the installer such as pressure limiting valve, tempering valve, line strainer, stop cocks, non-return valve, electrical switches, pumps or fuses, or faulty installation.

The Unit must be installed by a licensed plumber in accordance with information set out in the Owner's Manual and/ or Installer's Guide supplied with the Unit and/or any relevant statutory requirements.

In addition to this Warranty, certain legislation (including the ACL) may give you rights which cannot be excluded, restricted or modified. This Warranty must be read subject to such legislation and nothing in this Warranty has

the effect of excluding, restricting or modifying those rights.

If Dux fails to meet a guarantee under the ACL, your remedy for such failure may be limited to any one or more of the following:

- replacement of the Unit;
- repair of the Unit;
- refunding the cost of the Unit;
- payment of reasonable costs of having the Unit repaired;
- payment in respect of the reduced value of the Unit.

Any defective part of the Unit must be returned to the point of sale before replacement can be considered under the terms of this Warranty. If the costs of returning any defective parts are unreasonable, please contact Dux on 1300 365 115 (Australia) or 0800 729 389 (New Zealand) so that we can arrange a collection if appropriate.

Warranty claims can be made at the point of sale or by posting or faxing a warranty claim to Dux (contact details listed below) within one (1) month of the appearance of a defect. Warranty claims under this extended warranty must include the following details:

- Date of Purchase;
- Location of Purchase;
- Proof of Purchase;



## Warranty

- Date of Installation;
- Contact Details
- Product Serial Number

### Contact details

Dux's contact details are as follows:

#### Business Address:

Dux Manufacturing Limited  
Lackey Road  
Moss Vale, NSW, 2577  
Australia

#### Telephone:

1300 365 115 (Australia)  
0800 729 389 (New Zealand)

#### Facsimile:

(61 2) 4868 0257

#### Email:

[duxaftersales@gwagroup.com.au](mailto:duxaftersales@gwagroup.com.au)

**Note:** If the Unit is located in a position that does not comply with the installation instructions or relevant statutory requirements, then this Warranty does not cover major dismantling or removal of cupboards, doors, walls or special equipment and/or excessive labour, at the determination of Dux, to make the Unit accessible for repair or replacement.

As required by legislation, including under the ACL, any claims for damage to furniture, carpets, walls, foundations or any other consequential loss either

directly or indirectly due to defects of any kind in a Unit will only be met by Dux where the damage could be considered reasonably foreseeable.

Our goods come with guarantees that cannot be excluded under the Australian Consumer Law. You are entitled to a replacement or refund for a major failure and for compensation for any other reasonably foreseeable loss or damage. You are also entitled to have the goods repaired or replaced if the goods fail to be of acceptable quality and the failure does not amount to a major failure.



# Other Information

Product Warranty is applicable only in Australia and New Zealand.

See page 19 for terms of warranty.

*Privacy Act Amendment (2000):* If and whenever warranty service is required, your personal details will be given to an Authorised Dux Service Agent only for the express purpose of carrying out the arranged warranty service work agreed by you the client and Dux Manufacturing Limited.

### Your Details

For future convenience, fill in the following details and retain with your original invoice for your own records.

Surname:.....Given Name(s):.....

Address:.....

Town/Suburb:.....

State/Territory:..... Postcode:.....

Date of Purchase:..... Purchased From:.....

Model:..... Serial Number (located on back cover):.....

Date of Manufacture:.....

(Details on Data Label on water heater)

### Installer's Details:

Date of Installation:..... Installer's Name:.....

Address:.....

Installer's Signature:.....

### Service Details:

Date of Service:..... Serviced By:.....

Work Carried Out:.....

.....

.....

Signature of Service Agent:.....



Owner's Manual – Prodigy 5



# prodigy 5<sup>®</sup>

## 5 Star Gas Flue Damper Hot Water Heater

For advice, repairs and service, call:

1300 365 115 (Australia)

0800 729 389 (New Zealand)



### Please Register Your Water Heater



Please take a moment to fill out your details for warranty registration at:

[www.dux.com.au/warranty](http://www.dux.com.au/warranty)

or use your smartphone to scan this code:



This will ensure all your current details are registered with us for prompt warranty service if required.

### Preventative Maintenance



Maintaining your hot water system will help extend its lifespan and reduce running costs.

Please register for preventative maintenance at:

[www.dux.com.au/maintenance](http://www.dux.com.au/maintenance)

Serial Number

