



Operating instructions for dishwashers



To avoid the risk of accidents or damage to the appliance, it is **essential** to read these instructions as well as the installation plan before it is installed and used for the first time.



Guide to the appliance	6
Appliance overview	6
Control panel	7
Warning and Safety instructions	8
Caring for the environment	17
Disposal of the packing material	17
Disposing of your old appliance	17
Energy-saving dishwashing	18
Before using for the first time	19
Opening the door	19
Closing the door	19
Safety lock	19
Water softener	20
Displaying and setting the water hardness level	21
Before using the appliance for the first time, you require:	23
Dishwasher salt	23
Filling the salt reservoir	24
Add salt reminder 	25
Rinse aid	26
Adding rinse aid	26
Add rinse aid reminder 	27
Setting the rinse aid dosage	28
Loading the dishwasher	29
Notes	29
Upper basket	31
Adjusting the upper basket	32
Lower basket	33
Cutlery	34
Cutlery tray	34
Cutlery basket (depending on model)	35
Loading examples	36
Dishwashers with cutlery tray	36
Dishwashers with cutlery basket	38
Comparison tests	40
Standard height with cutlery tray	40
XXL height with cutlery tray	43
Standard and XXL height with cutlery basket	46

Contents

Operation	49
Detergent.....	49
Adding detergent.....	51
Switching on the dishwasher	52
Selecting a programme	52
Starting the programme	53
Display.....	53
Energy management	54
Programme finished	54
Switching off.....	55
Unloading the dishwasher.....	55
Interrupting a programme.....	56
Changing a programme.....	56
Programme options	57
Turbo	57
DetergentAgent	57
Switching off the refill indicators	58
Delay start	59
Adjust Sensor wash.....	61
Optimise standby	62
Factory default settings.....	63
Programme chart	64
Cleaning and care	68
Cleaning the wash cabinet.....	68
Cleaning the door and the door seal.....	68
Cleaning the door front	69
Checking the filters in the wash cabinet	70
Cleaning the filters.....	70
Cleaning the spray arms.....	72
Problem solving guide	73
Technical problems	73
Water inlet fault	75
Water drainage fault	75
General problems.....	76
Noises.....	77
Unsatisfactory washing result	78
Maintenance	81
Cleaning the water inlet filter.....	81
Cleaning the drain pump and non-return valve.....	82

Contents

After sales service	83
Repairs	83
Warranty	83
Optional accessories	84
Electrical connection	86
Water connection	87
The Miele Waterproof system.....	87
Connection to the water supply	87
Drainage	88
Technical data	89

Guide to the appliance

Appliance overview

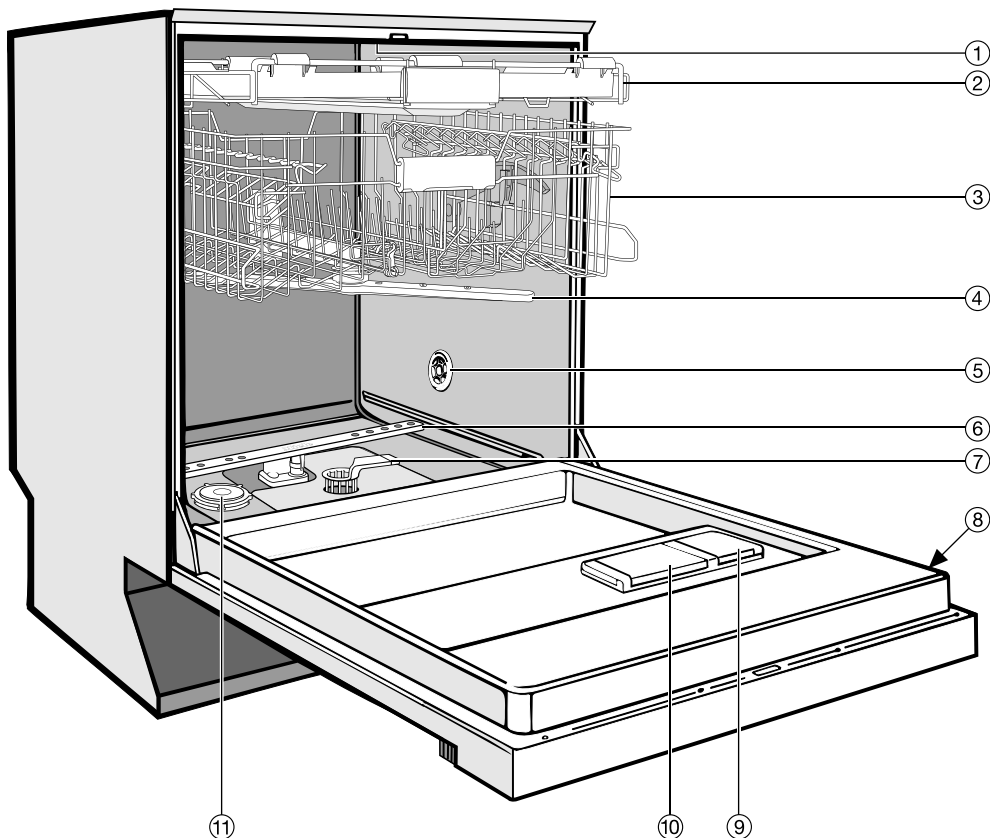

- | | |
|---|--|
| ① Upper spray arm (not visible) | ⑦ Filter combination |
| ② Cutlery tray (depending on model) | ⑧ Data plate |
| ③ Upper basket | ⑨ Rinse aid reservoir |
| ④ Middle spray arm | ⑩ Dual compartment detergent dispenser |
| ⑤ Air inlet for drying (depending on model) | ⑪ Salt reservoir |
| ⑥ Lower spray arm | |

Control panel

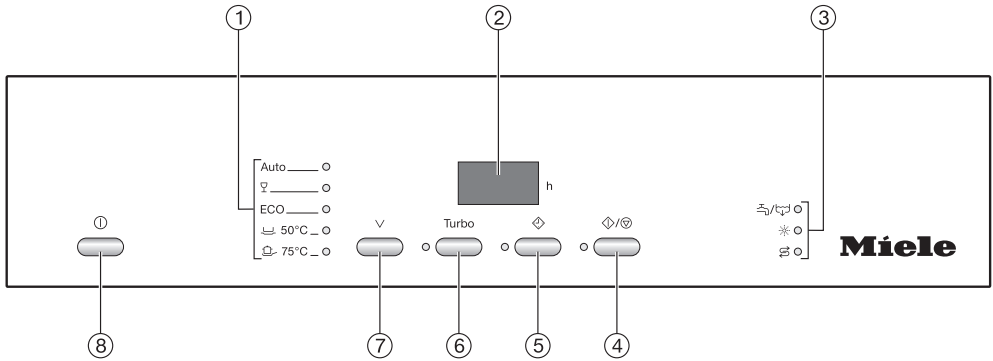

- ① Programme selection
 Auto = Sensor wash
 ♪ = Gentle 45°C
 ECO = ECO
 ☹ = 50°C = Light soiling 50°C
 ☹☹ = 75°C = Pots & pans 75°C
- ② Time display
- ③ Check/Refill indicators
 ♪/☹ = Inlet/Drain
 ✨ = Rinse aid
 Ⓔ = Salt
- ④ ⏻/⏹ button (Start/Stop) with indicator light
- ⑤ Delay start button ⏸ with indicator light
- ⑥ Turbo button with indicator light
- ⑦ Programme selector button ∇
- ⑧ On/Off button ①

These operating instructions apply to several different dishwasher models with different heights.

The specific dishwasher models are referred to as follows:

Standard = 80.5 cm high dishwashers (integrated)

and 84.5 cm high dishwashers (freestanding)

XXL = 84.5 cm high dishwashers (integrated)

Warning and Safety instructions

This dishwasher complies with current safety requirements. Inappropriate use can, however, lead to personal injury and damage to property.

To avoid the risk of accidents and damage to the dishwasher, please read the installation plan and the operating instructions carefully before it is installed and used for the first time. They contain important information on its installation, safety, use and maintenance.

Keep the installation plan and the operating instructions in a safe place and pass them on to any future owner.

Miele cannot be held liable for damage caused by non-compliance with this information.

Correct application

- ▶ This appliance is designed for domestic use and for use in similar environments by guests in hotel or motel rooms, bed & breakfasts and other typical living quarters. This does not include common/shared facilities or commercial facilities within hotels, motels or bed & breakfasts.
- ▶ This dishwasher is not suitable for outdoor use.
- ▶ It must only be used as specified in these operating instructions for cleaning domestic crockery and cutlery. Any other usage is not supported by the manufacturer and could be dangerous.
- ▶ This appliance is not intended for use by persons (including children) with reduced physical, sensory or mental capabilities, or lack of experience and knowledge, unless they have been given supervision or instruction concerning its use by a person responsible for their safety, and are able to recognise the dangers of misuse.

Warning and Safety instructions

Safety with children

- ▶ Young children must not be allowed to use this appliance.
- ▶ Older children may only use the appliance when its operation has been clearly explained to them and they are able to use it safely, recognising the dangers of misuse.
- ▶ Cleaning work may only be carried out by older children under the supervision of an adult.
- ▶ Children should be supervised to ensure that they do not play with the appliance. Keep small children away from the appliance at all times to avoid the risk of injury. There is the risk that children may lock themselves in the dishwasher.
- ▶ If the automatic door opening mechanism (depending on model) is active, keep young children away from the area in which the door opens. Danger of injury in the unlikely event of a fault with the opening mechanism.
- ▶ Danger of suffocation! Children may be able to wrap themselves in packing material or pull it over their heads with the risk of suffocation. Keep children away from any packing material.
- ▶ Keep detergent and other household agents out of the reach of children at all times. Some dishwasher detergents are strongly alkaline and contain irritants and corrosive ingredients. They can be extremely dangerous if swallowed, and can cause burning in the mouth, nose and throat, or inhibit breathing. Avoid contact with the skin and eyes. Keep children away from the dishwasher when the door is open. There could still be detergent residues in the cabinet or dispenser. Check that the dispenser is empty after the completion of a programme. Seek medical advice immediately if your child has swallowed or inhaled detergent, e.g. Poisons Information Centre (Australia) or National Poisons Centre (NZ).

Technical safety

▶ Repairs and other work by unqualified persons could be dangerous. Installation, maintenance work and repairs to electrical appliances must only be carried out by a Miele approved service technician.

▶ Before installation, check the dishwasher for visible signs of damage. Under no circumstances should you use a damaged dishwasher. A damaged dishwasher could be dangerous.

▶ The electrical safety of this appliance can only be guaranteed when continuity is complete between it and an effective earthing system. It is most important that this basic safety requirement is present and regularly tested and, where there is any doubt, the electrical system in the house should be checked by a qualified electrician.

Miele cannot be held liable for the consequences of an inadequate earthing system (e.g. electric shock).

▶ Reliable and safe operation of this dishwasher can only be assured if it has been connected to the mains electricity supply.

▶ The dishwasher must only be plugged into the electricity supply via a suitable switched socket. The electrical socket must be easily accessible after the dishwasher is installed so that it can be disconnected from the electricity supply at any time.

▶ There must be no electrical sockets behind the dishwasher. Danger of overheating and fire risk if the dishwasher were to be pushed up against a plug.

▶ The dishwasher must not be installed under a cooktop. The high radiant temperatures which are sometimes generated by a cooktop could damage the dishwasher. For the same reason, it should not be installed next to open fires or other appliances which give off heat, such as heaters etc.

Warning and Safety instructions

▶ To avoid the risk of damage to the dishwasher, make sure that the connection data on the data plate (fuse rating, voltage and frequency) matches the mains electricity supply before connecting the dishwasher to the mains. Consult a qualified electrician if in any doubt.

▶ Do not connect the dishwasher to the mains supply until it has been fully installed and any adjustment has been made to the door springs.

▶ The dishwasher may only be operated if the door opening mechanism is working correctly. Otherwise there could be a risk of injury whilst the automatic door opening mechanism (depending on model) is active.

To check that the door opening mechanism is working correctly:

- the door springs must be adjusted equally on both sides. They are correctly adjusted when the door remains stationary when left half open (approx. 45° opening angle). It is also important that the door cannot fall open.
- the door locking pins automatically retract when the door opens at the end of the drying phase.

▶ Do not connect the appliance to the mains electricity supply by a multi-socket adapter or an extension lead. These do not guarantee the required safety of the appliance (e.g. danger of overheating).

▶ This appliance must not be installed and operated in mobile installations (e.g. on a ship).

▶ Do not install the dishwasher in a room where there is a risk of frost. Frozen hoses may burst or split. The reliability of the electronic control unit may be impaired at temperatures below freezing point.

▶ To avoid any damage to the appliance, the dishwasher must only be operated when it is connected to a fully vented plumbing system.

▶ The plastic housing of the water connection contains an electrical valve. The housing must not be dipped in water.

Warning and Safety instructions

- ▶ There are electrical wires in the water inlet hose. Do not cut the water inlet hose, even if it is too long.
- ▶ The integrated Waterproof system offers protection from water damage, provided the following conditions are met:
 - The dishwasher is correctly installed and plumbed in.
 - The dishwasher is properly maintained and parts are replaced where it can be seen that this is necessary.
 - The tap has been turned off when the appliance is not used for a longer period of time (e.g. during holidays).

The Waterproof system will work even if the appliance is switched off. However, the appliance must remain connected to the electricity supply.

- ▶ The water pressure (flow pressure at the connection point) must be between 50 and 1000 kPa (0.5 and 10 bar).
- ▶ A damaged appliance could be dangerous. If the dishwasher gets damaged, switch it off at the mains and call Miele.
- ▶ The manufacturer's warranty will be invalidated if the appliance is not repaired by a Miele approved service technician.
- ▶ Faulty components must only be replaced by genuine Miele spare parts. The manufacturer can only guarantee the safety of the appliance when Miele replacement parts are used.
- ▶ During installation, maintenance and repair work, the appliance must be disconnected from the mains electricity supply.
- ▶ If the mains connection cable is damaged, it must be replaced with a special cable of the same type (available from Miele) by a Miele authorised service technician only in order to avoid a hazard.

Warning and Safety instructions

▶ In areas which may be subject to infestation by cockroaches or other vermin, pay particular attention to keeping the appliance and its surroundings in a clean condition at all times. Any damage which may be caused by cockroaches or other vermin will not be covered by the warranty.

Correct installation

▶ The dishwasher must be installed and connected in compliance with the installation instructions.



▶ Be careful when installing the dishwasher. Wear protective gloves to avoid injury on any sharp metal components.

▶ The dishwasher must be correctly aligned to ensure problem-free operation.

▶ In order to ensure stability, built-under and integrated dishwashers must only be installed under a continuous worktop which is secured to adjacent cabinetry.

▶ If you want to convert your freestanding dishwasher to a built-under ("U") model, you will need to order the appropriate conversion kit. If you remove the existing plinth, you must replace it with a U-model plinth. This is necessary to avoid the risk of injury caused by protruding metal parts.

▶ The door springs on either side need to be evenly adjusted. They are correctly adjusted if the half-opened door (approx. 45° door opening angle) remains in this position when it is released. The door must not fall down under its own weight.

The appliance may only be used with correctly adjusted door springs.

Correct use

- ▶ Do not use solvents in the dishwasher. Danger of explosion!
- ▶ Do not inhale or ingest dishwasher detergent. Some dishwasher detergents are strongly alkaline and contain irritants or corrosive ingredients. They can be extremely dangerous if swallowed, and can cause burning in the nose, mouth and throat, or inhibit breathing. Avoid contact with the skin and eyes. Seek medical advice immediately if detergent has been swallowed or inhaled, e.g. Poisons Information Centre (Australia) or National Poisons Centre (NZ).
- ▶ Avoid leaving the door open unnecessarily as someone could trip over it and be injured by it.
- ▶ Do not sit or lean on the opened door. This could cause the dishwasher to tip and be damaged, and you could get injured.
- ▶ Dishes can be very hot at the end of a programme. Allow them to cool until they are comfortable enough to handle before unloading.
- ▶ Only use detergent and rinse aid formulated for domestic dishwashers. Do not use washing-up liquid.
- ▶ Do not use commercial or industrial detergents as these may cause damage, and there is a risk of a severe explosive chemical reaction (such as an explosive oxyhydrogen gas reaction).
- ▶ Do not fill the rinse aid reservoir with powder or liquid detergent. This will cause serious damage to the reservoir.
- ▶ Inadvertently filling the salt reservoir with powder or liquid dishwasher detergent will damage the water softener. Make sure you have picked up the correct packet of dishwasher salt before filling the salt reservoir!
- ▶ Only use special coarse grained dishwasher salt for reactivation. Do not use other salts such as cooking salt, agricultural grade or gritting salt. These may contain insoluble additives which can impair the functioning of the water softener.

Warning and Safety instructions

- ▶ In an appliance with a cutlery basket (depending on model) cutlery is cleaned and dried more efficiently if placed in the basket with the handles downwards. However, to avoid the risk of injury, place knives and forks etc. with the handles upwards.
- ▶ Plastic items which cannot withstand being washed in hot water, such as disposable plastic containers, or plastic cutlery and crockery should not be cleaned in the dishwasher. The high temperatures in the dishwasher may cause them to melt or lose shape.
- ▶ If you use the "FlexiTimer/Delay start" option (depending on model), make sure that the dispenser is dry before adding detergent. Wipe dry if necessary. Detergent will clog if poured into a damp dispenser and may not be thoroughly dispersed.
- ▶ Please observe the information given in "Technical data" regarding the capacity of the dishwasher.

Accessories

- ▶ Use only genuine original Miele spare parts. If spare parts or accessories from other manufacturers are used, the warranty will be invalidated, and Miele cannot accept liability.

Disposal of your old dishwasher

- ▶ Make the door lock inoperative so that children cannot accidentally shut themselves in. Remove or destroy the locking bracket of the door lock, and make appropriate arrangements for the disposal of the appliance.

Disposal of the packing material

The packaging is designed to protect the appliance from damage during transportation. The packaging materials used are selected from materials which are environmentally friendly for disposal and should be recycled.

The packaging consists of the following materials:

Outer packaging:

- Corrugated cardboard made from up to 100% recyclable material:
or: Polyethylene (PE) shrink wrap
- Polypropylene (PP) strapping

Inner packaging:

- Chlorine and fluorine free expanded polystyrene (EPS)
- Base, lid frame and support battens made from untreated natural wood from renewable forests
- Polyethylene (PE) protective wrap

Recycling the packaging reduces the use of raw materials in the manufacturing process and also reduces the amount of waste in landfill sites. Rather than just throwing these materials away, please ensure they are recycled.

 Ensure that any plastic wrappings, bags, etc. are disposed of safely and kept out of the reach of babies and young children. Danger of suffocation.

Disposing of your old appliance

Electrical and electronic appliances often contain materials which, if handled or disposed of incorrectly, could be potentially hazardous to human health and to the environment. They are, however, essential for the correct functioning of your appliance. Therefore, please do not dispose of your old appliance with your household waste.

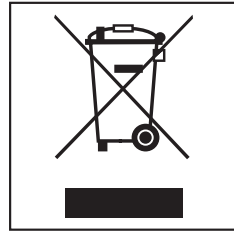

Please dispose of it at your local community waste collection / recycling centre.

Ensure that your old appliance presents no danger to children while being stored for disposal.

To enable sorting by type of plastic for recycling, all plastic parts of the appliance are labelled with international standard symbols.

Energy-saving dishwashing

This dishwasher is exceptionally economical in its use of water and electricity.

You can make the most of your appliance by following these tips:

- For most economical dishwashing, make full use of the baskets without overloading the dishwasher.
- Choose the programme to suit the type of crockery being washed and the degree of soiling.
- Select the *ECO* programme for energy-saving dishwashing. This programme is the most efficient in terms of its combined energy and water consumption at cleaning normally soiled crockery.
- Follow the detergent manufacturer's recommendations on detergent dosage.
- When using powder or liquid detergent you can use $\frac{1}{3}$ less detergent if baskets are only half full.
- If your household water system is suitable, this dishwasher can be connected to a hot water supply for further economies. If the water is heated by solar panels, for example, this would be energy efficient. However, if your water is heated by electricity, we would recommend connection to cold water.

You can find further tips on energy-saving dishwashing in "Miele's guide to dishwashing".

Before using for the first time

Opening the door

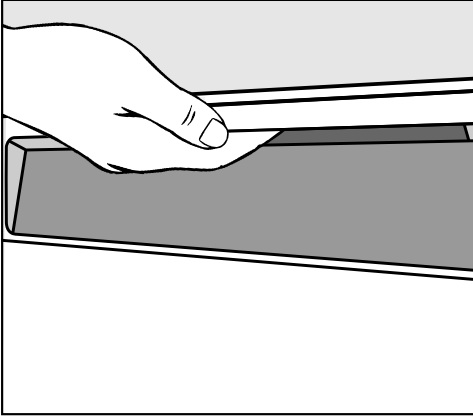

- To open the door, reach under the door grip and pull.

If the door is opened during operation, all functions are automatically interrupted.

 Water in the dishwasher may be hot. Danger of scalding!
Only open the door during operation if absolutely necessary and exercise extreme caution when doing so.

Closing the door

- Push the baskets right in.
- Then lift the door upwards and push until it clicks into position.

 Danger of injury!
Do not put your hand inside the door as it is closing.

Safety lock

Use the safety lock to prevent children opening the dishwasher door.

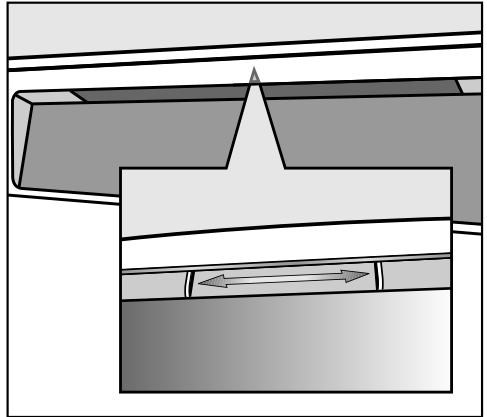

- To lock the door, push the slide underneath the door grip to the right.
- To unlock the door, push the slide to the left.

Before using for the first time

Water softener

In order to achieve good cleaning results, the dishwasher needs to operate with soft water. Hard water results in a build-up of calcium deposits on crockery and in the dishwasher.

Mains water with a hardness level higher than 0.7 mmol/l (4 °d - German scale) needs to be softened. This takes place automatically in the integrated water softener. The water softener in the dishwasher is suitable for a water hardness level of up to 12.6 mmol/l (70 °d - German scale).

- The water softener requires dishwasher salt.
Depending on the water hardness level (< 3.8 mmol/l, or 21 °d - German scale), dishwasher salt is not required if combination tablets are being used (see "Operation - Detergent").
- The dishwasher must be programmed for the water hardness level in your area.
- Your local water authority will be able to advise you of the water hardness level in your area.
- Where the water hardness fluctuates, e.g. between 1.8 and 2.7 mmol/l (10 - 15 °d - German scale), always programme the dishwasher to the higher value (2.7 mmol/l or 15 °d in this example).

In the event of a fault, it will help the service technician if you know the hardness of your local water supply.

Enter the water hardness below:

_____ mmol/l







The dishwasher is programmed at the factory for a water hardness level of 0.2 mmol/l (1 °d - German scale).

If this setting corresponds to the hardness of your water, you do not need to do anything more.

However, if you have a different water hardness, you must adjust the water softener to match your water hardness.

Before using for the first time

Displaying and setting the water hardness level

- Switch the dishwasher off with the ① button, if it is switched on.
- Press the / button in and, **whilst holding it in**, switch the dishwasher on using the ① button. Keep the / button pressed in for at least four seconds until the / indicator light comes on.



If this does not happen, start the procedure from the beginning again.

- Press the  button twice.

The  indicator light will flash rapidly twice at intervals.

The value which has been set for the water hardness is shown as a figure after *P* in the display (see chart).

P 15 will start flashing in the display. This is the factory default setting of 15 °d.

- Use the / button to select the value which equates to your water hardness level. Each press of the button moves you up a level. When the highest water hardness level is reached, the setting starts from the beginning again.

The setting is now stored in memory.

- Switch the dishwasher off with the ① button.

Before using for the first time

°d	mmol/l	°f	Display
1	0.2	2	1
2	0.4	4	2
3	0.5	5	3
4	0.7	7	4
5	0.9	9	5
6	1.1	11	6
7	1.3	13	7
8	1.4	14	8
9	1.6	16	9
10	1.8	18	10
11	2.0	20	11
12	2.2	22	12
13	2.3	23	13
14	2.5	25	14
15	2.7	27	15
16	2.9	29	16
17	3.1	31	17
18	3.2	32	18
19	3.4	34	19
20	3.6	36	20

°d	mmol/l	°f	Display
21	3.8	38	21
22	4.0	40	22
23	4.1	41	23
24	4.3	43	24
25	4.5	45	25
26	4.7	47	26
27	4.9	49	27
28	5.0	50	28
29	5.2	52	29
30	5.4	54	30
31	5.6	56	31
32	5.8	58	32
33	5.9	59	33
34	6.1	61	34
35	6.3	63	35
36	6.5	65	36
37-50	6.7-9.0	67-89	50
51-60	9.2-10.8	91-108	60
61-70	11.0-12.6	110-126	70

Before using for the first time

Before using the appliance for the first time, you require:

- approx. 2 litres of water,
- approx. 2 kg dishwasher salt,
- domestic dishwasher detergent,
- rinse aid formulated for domestic dishwashers.

Every dishwasher is tested at the factory. There will be residual water in the appliance from this test. It is not an indication that it has been used previously.

Dishwasher salt

In order to achieve good cleaning results, the dishwasher needs to operate with soft water. Hard water results in a build-up of calcium deposits on crockery and in the dishwasher. Mains water with a hardness level higher than 0.7 mmol/l (4 °d - German scale) needs to be softened. This takes place automatically in the integrated water softener. The water softener in the dishwasher is suitable for a water hardness level of up to 12.6 mmol/l (70 °d - German scale).

The water softener requires dishwasher salt.

Depending on the water hardness level (< 3.8 mmol/l, or 21 °d - German scale), dishwasher salt is not required if combination tablets are being used (see "Operation - Detergent").

If the water hardness in your area is constantly **lower than 0.9 mmol/l (5 °d)**, you do **not** need to add dishwasher salt. The prompt to add dishwasher salt will be switched off automatically. The water softener must, however, still be programmed to correspond to the water hardness level in your area.

 Dishwasher detergent will damage the water softener. Do not fill the salt reservoir with powder or liquid detergent.

 Only use special coarse grained dishwasher salt for reactivation, as other salts (e.g. cooking salt, agricultural grade or gritting salt) may contain insoluble additives which can impair the functioning of the water softener.

Before using for the first time

Filling the salt reservoir

Before filling the salt reservoir with dishwasher salt for the first time, you must fill it with approx. 2 litres of water to enable the salt to dissolve. Once the dishwasher has been used, there is always sufficient water in the reservoir.

- Remove the lower basket and unscrew the salt reservoir cap.

Water or saline solution will run out of the reservoir when the cap is removed.

It should therefore only be removed in order to refill the salt reservoir.

- Fill the reservoir with approx. 2 litres of water (first use only).

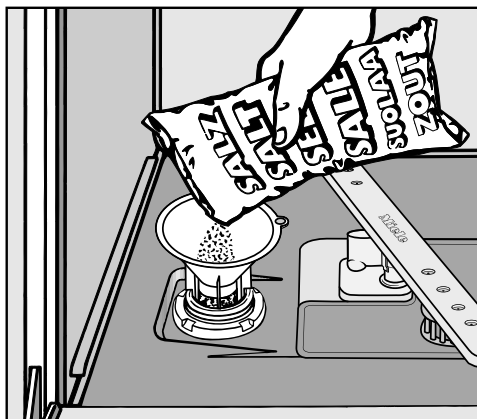

- Place the funnel provided over the salt reservoir and carefully fill with dishwasher salt until the reservoir is full. The salt reservoir holds approx. 2 kg of salt depending on the brand used.
- Clean any excess salt from around the reservoir opening and then screw the cap on again firmly.
- Immediately after filling the salt reservoir, run the *Gentle 45°C* ☹ programme with the *Turbo* programme option selected and without any crockery in the dishwasher to remove any traces of salt from the cabinet.

Before using for the first time

Add salt reminder

- Fill the salt reservoir with dishwasher salt when the *Salt*  indicator light comes on (If it comes on during a programme, wait until the end of the programme).



Risk of corrosion!
Immediately after filling the salt reservoir, run the *Gentle 45°C*  programme with the *Turbo* programme option selected and without any crockery in the dishwasher to remove any traces of salt from the cabinet.

After the salt reservoir has been filled, the refill indicator may still be lit up if the salt concentration has not yet reached the correct level. It will go out when the correct concentration is reached.

The refill reminder will be switched off if you have programmed the dishwasher for a water hardness below 0.9 mmol/l (5 °d - German scale).

If you only ever use multi-function combination products in your dishwasher, you can switch off both refill reminders for salt and rinse aid if you wish (see "Programme options - Switching off the refill indicators").

If you switch to using detergent that does not contain salt or rinse aid, it is important to remember to add dishwasher salt and rinse aid and to switch the reminders back on.

Before using for the first time

Rinse aid

Rinse aid is necessary to ensure water does not cling and leave marks on crockery during the drying phase and helps crockery dry faster after it has been washed.

Rinse aid is poured into the storage reservoir and the amount set is dispensed automatically.

⚠ Inadvertently filling the rinse aid reservoir with powder or liquid detergent will damage the reservoir. Only pour rinse aid formulated for domestic dishwashers into the reservoir.

Alternatively, it is possible to use

- household vinegar with a max. 5% acid content

or

- liquid citric acid up to 10% acid content

The resulting rinsing and drying quality will not, however, be as good as when rinse aid is used.

⚠ Do not use vinegar with a higher acid content (e.g. vinegar essence 25% acid). This would damage the dishwasher.

If you only ever use combination products containing rinse aid in your dishwasher, you do not need to add rinse aid.

Adding rinse aid

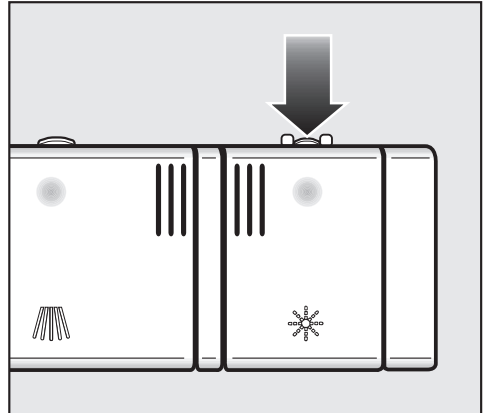

- Press the button on the lid of the rinse aid reservoir in the direction of the arrow until the flap springs open.

Before using for the first time

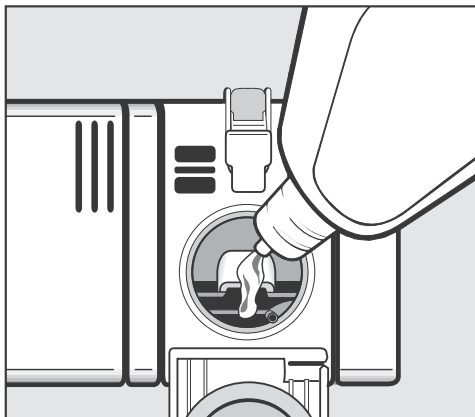

Add rinse aid reminder ✱

When the *Rinse aid* ✱ indicator light comes on, the reservoir contains sufficient rinse aid for 2 - 3 programmes only.

- Add rinse aid in plenty of time.

If you only ever use multi-function combination products in your dishwasher, you can switch off both refill reminders for salt and rinse aid if you wish (see "Programme options - Switching off the refill indicators").

If you switch to using detergent that does not contain salt or rinse aid, it is important to remember to add dishwasher salt and rinse aid and to switch the reminders back on.

- Add rinse aid only until it is visible in the opening.

The rinse aid reservoir holds approx. 110 ml.

- Close the flap firmly so that it clicks into place. Otherwise water can enter the rinse aid reservoir during a programme.
- Wipe up any spilled rinse aid. This prevents over-foaming occurring during the next programme.

Before using for the first time

Setting the rinse aid dosage

You can adjust the rinse aid dosage for best results.

The rinse aid dosage is set in stages from 0 to 6. It is set to 3 at the factory. This is the recommended setting.

If the "Adjust Sensor wash" programme function (depending on model) has been activated, the amount of rinse aid dispensed in the *Sensor wash* programme can be higher than that set.







If spots appear on crockery and glassware:

- Increase the rinse aid dosage.

If clouding or smearing appears on crockery and glassware:

- Decrease the rinse aid dosage.

- Switch the dishwasher off with the ① button, if it is switched on.

- Press the / button in and, **whilst holding it in**, switch the dishwasher on using the ① button. Keep the / button pressed in for at least four seconds until the / indicator light comes on.

If this does not happen, start the procedure from the beginning again.



- Press the  button three times.

The  indicator will flash rapidly 3 times at intervals.

The dosage set will appear in the display after *P*.

The flashing sequence *P 3* will appear in the display.

This indicates the factory default setting 3.

- Use the / button to select the setting required. Each press of the button moves you up a level. After reaching the highest value, the counter starts from the beginning again.

The setting is now stored in memory.

- Switch the dishwasher off with the ① button.

Notes

Remove coarse food residues from crockery.

There is no need to rinse items under running water.

 Do not wash items soiled with ash, sand, wax, lubricating grease or paint in the dishwasher. Ash does not dissolve and is distributed in the wash cabinet. Wax, sand, lubricating grease and paint cause damage to the dishwasher.

Crockery can be loaded anywhere in the baskets, but the following notes should be observed:

- Do not place crockery and cutlery inside other pieces where they may be concealed.
- Load the crockery so that water can access all surfaces. This ensures that they get properly cleaned.
- Make sure that all items are securely positioned.
- Hollow items such as cups, glasses, pans, etc. must be inverted in the basket.
- Tall, narrow, hollow items, e.g. champagne glasses, should be placed in the centre of the basket to ensure better water coverage.
- Wide based items should be placed at an angle so that water can run off them freely.

- The spray arms must not be blocked by items which are too tall or hang through the baskets. If in doubt, test for free movement by manually rotating the spray arms.
- Make sure that small items cannot fall through the holders in the baskets.
Small items, e.g. lids, should therefore be placed in the cutlery tray or cutlery basket (depending on model).

Some foodstuffs may contain natural dyes, e.g. carrots, tomatoes or tomato sauce. Plastic items in the dishwasher may discolour if large quantities of these foodstuffs find their way into the dishwasher on the crockery. The stability of plastic items is not affected by this discolouration.
Cleaning silver cutlery in the dishwasher may also cause plastic items to discolour.

Loading the dishwasher

Items not suitable for dishwashers:

- Wooden cutlery and crockery or items with wooden parts: these may discolour and fade. The glue used in these items is not dishwasher-proof and wooden handles may come loose after being washed in a dishwasher.
- Craft items, antiques, valuable vases and decorative glassware are also not suitable for dishwashers.
- Plastic items which are not heat-resistant: the high temperatures in the dishwasher may cause them to melt or lose shape.
- Copper, brass, tin and aluminium items may discolour or become matt.
- Colours painted over a glaze may fade after a number of washes.
- Delicate glassware and glassware containing lead crystal: clouding may occur over time.

Please note

Silverware previously cleaned with a **silver polish** may still be damp or spotted at the end of a programme, where water has not run off smoothly. It may need to be rubbed dry with a soft cloth.

Silver which has been in contact with foods containing sulphur can discolour. These include egg yolk, onions, mayonnaise, mustard, pulses, fish, fish brine and marinades.

 Aluminium components (e.g. rangehood grease filters) must not be cleaned with caustic alkaline commercial or industrial cleaning agents.

These may damage the material, or in extreme cases, there is a risk of a severe explosive chemical reaction (such as an explosive oxyhydrogen gas reaction).

Useful tip: When purchasing new crockery and cutlery, make sure they are dishwasher-proof.

Glass care

- Clouding may occur on glasses after frequent washing. If delicate glassware is washed in the dishwasher, ensure that only very low temperatures are used (see programme chart), or a special glass-care programme is used (depending on model). This will reduce the risk of clouding.
- Purchase glassware which is dishwasher-safe (e.g. Riedel glassware).
- Use detergents with glass protective additives (e.g. Miele CareCollection tabs).
- Visit "<http://www.mieleglasscare.com/international/en/glasscare/english>" for more information on glass care.

Upper basket

See "Loading the dishwasher / Loading examples" for examples of how to load crockery and cutlery.

 For safety reasons, do not operate the dishwasher without the upper and lower baskets in place (except when running the Tall items programme, if available).

- Use the upper basket for small, lightweight and delicate items such as cups, saucers, glasses, dessert bowls, etc.
Shallow pans or casserole dishes can also be placed in the upper basket.
- Long items such as soup ladles, mixing spoons and long knives should be placed lying down across the front of the upper basket.

Cup rack

- To make room for tall items, raise the rack upwards.

Glasses can be arranged along the positioning rail of the cup rack to give them some support during the programme.

- Lower the cup rack and lean the glasses against it.

Loading the dishwasher

Adjusting the upper basket

In order to gain more space for taller pieces of crockery in the bottom or upper basket, the upper basket can be adjusted on three levels with 2 cm between each level.

The upper basket can also be set at an angle with one side high and the other side low. This can be useful to help prevent water being left in deep dishes etc. Ensure, however, that the basket can be inserted smoothly into the cabinet. It is better to adjust the basket before loading it.

- Pull out the upper basket.

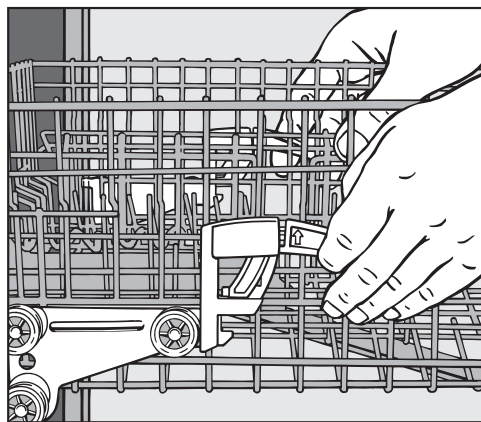

To raise the upper basket:

- Pull the basket up until it clicks into place.

To lower the upper basket:

- Pull upwards on the levers at either side of the upper basket.
- Adjust the basket to the desired height and then push the levers securely back down into position.

Depending on the setting of the upper basket, the following plate dimensions can be accommodated.

Dishwashers with cutlery basket (see data plate for model number)

Upper basket level	Plate Ø in cm		
	Upper basket		Lower basket
	Stand-ard	XXL	
Top	20	24	31 (35*)
Middle	22	26	29
Bottom	24	28	27

Dishwashers with cutlery tray (see data plate for model number)

Upper basket level	Plate Ø in cm		
	Upper basket		Lower basket
	Stand-ard	XXL	
Top	15	19	31 (35*)
Middle	17	21	29
Bottom	19	23	27

* When tilted, plates of up to 35 cm can be accommodated (see "Lower basket").

Loading the dishwasher

Lower basket

See "Loading the dishwasher - Loading examples" for examples of how to load crockery and cutlery.

- For larger and heavier items such as plates, serving platters, saucepans, bowls, etc.
Glasses, cups and small items such as saucers can also be placed in the lower basket. Do not place thin, delicate glassware in the lower basket.

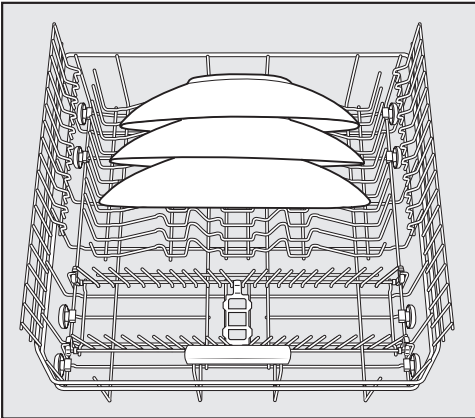

- Place large platters and dishes in the centre of the lower basket.

When tilted, plates up to 35 cm in diameter can be accommodated.

MultiComfort area

The rear section of the lower basket is used for washing cups, glasses, plates, pots and pans.

Hinged spikes

The spikes at the front are used for washing plates, soup bowls, platters, dessert bowls and saucers.

Both rows of spikes can be lowered to make more room for large items, e.g. pots, pans and dishes.

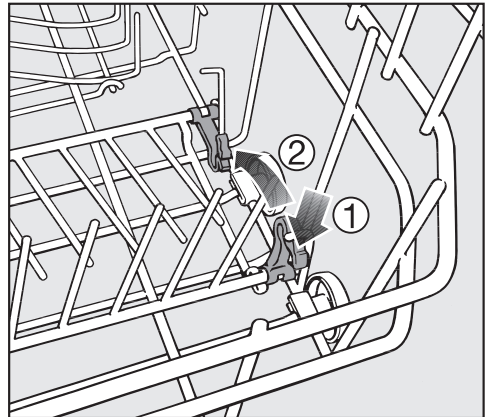

- Press the yellow lever downwards ①, and then lower the spikes ②.

Loading the dishwasher

Cutlery

Cutlery tray

See "Loading the dishwasher - Loading examples" for examples of how to load crockery and cutlery.

- Arrange the cutlery in the tray as shown.

To make unloading much easier, cutlery should be grouped in zones, one for knives, one for forks, one for spoons, etc.

Spoon heads should be placed in contact with at least one of the serrated retainers on the base of the cutlery tray to ensure that water runs off them freely.

The upper spray arm must not be blocked by items which are too big (e.g. cake servers).

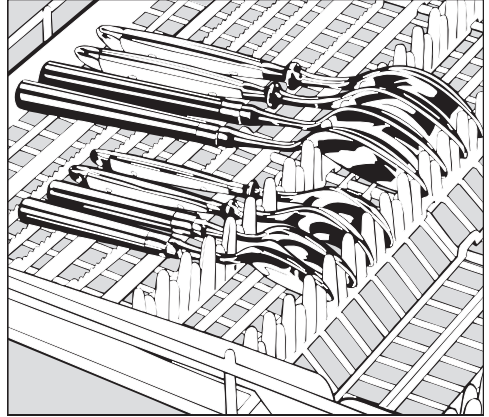

- If spoon handles do not fit between the holders, then lay them the other way round.

Loading the dishwasher

Cutlery basket (depending on model)

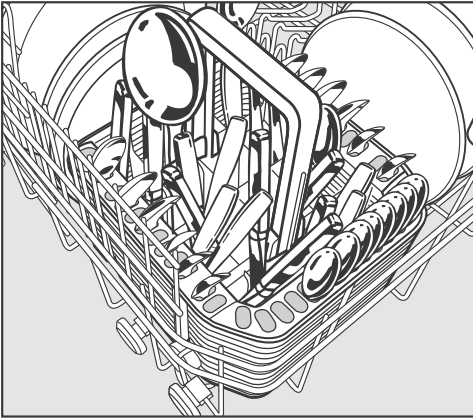

The cutlery basket can be placed anywhere on the front rows of spikes in the lower basket.

- To avoid the risk of injury, knives and forks should be placed with the handles upwards in the basket. However, cutlery placed handle down in the basket will come out cleaner and drier.
- Place small items of cutlery in the individual slots on three sides of the cutlery basket.

Cutlery insert for the cutlery basket

Use the insert supplied for heavily soiled items of cutlery. The insert separates the items so that they can be more easily accessed by water.

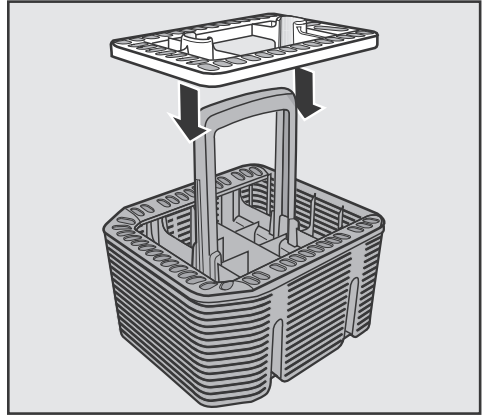

- Fit it onto the cutlery basket if required.

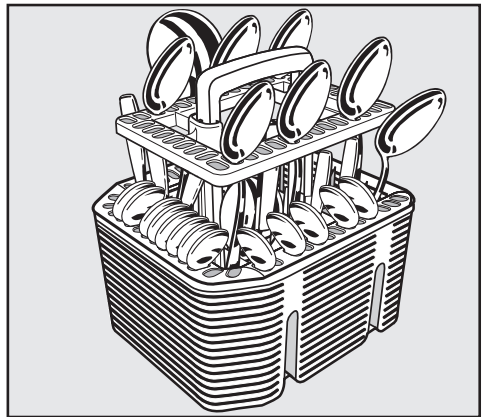

- Insert cutlery with the handles facing downwards.
- Distribute them evenly along the insert.

Loading the dishwasher

Loading examples

Dishwashers with cutlery tray

Upper basket

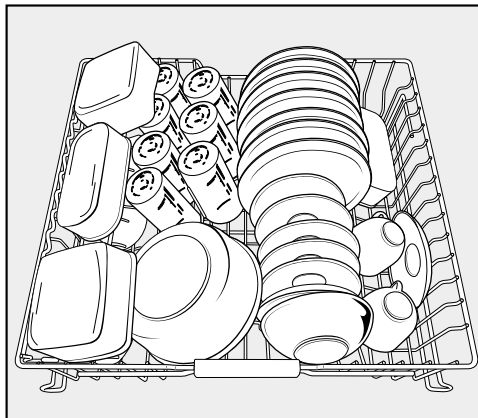
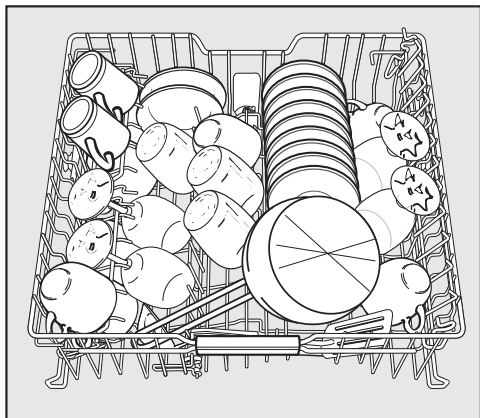

Lower basket

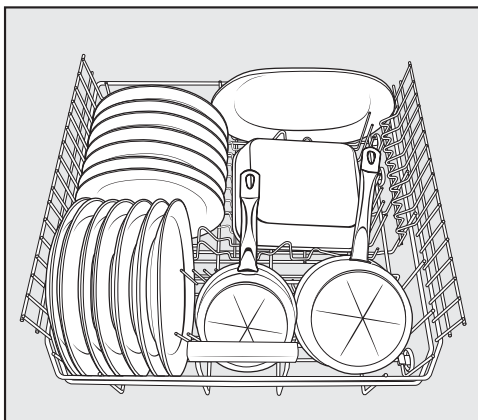
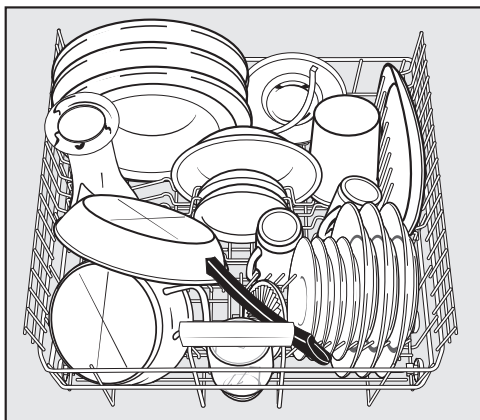

Loading the dishwasher

Cutlery tray

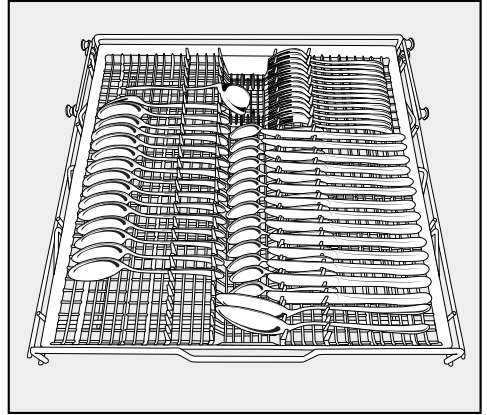
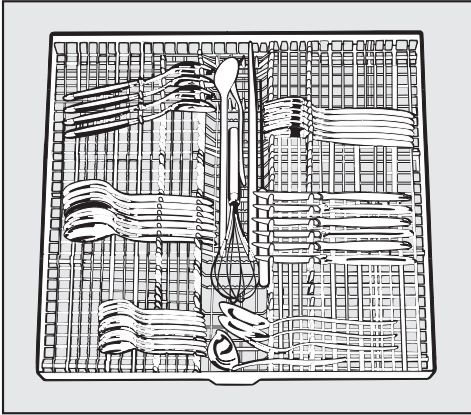

Heavily soiled items

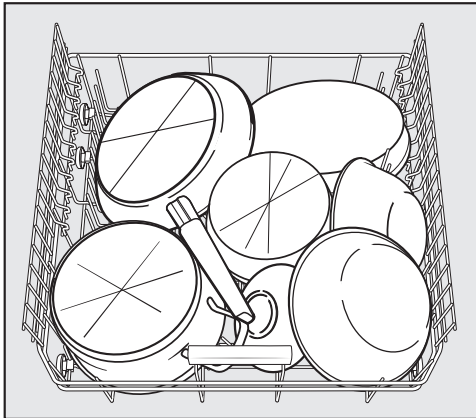

Loading the dishwasher

Dishwashers with cutlery basket

Upper basket

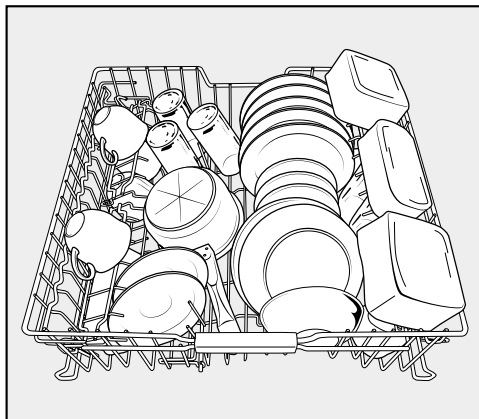
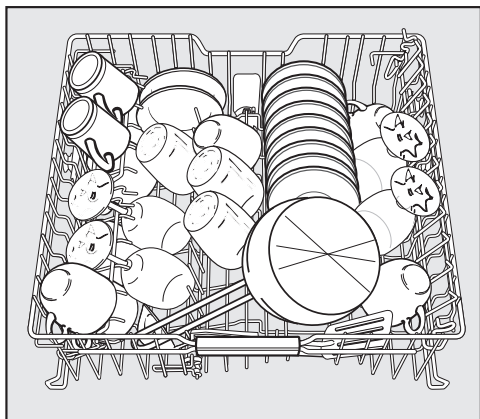

Lower basket

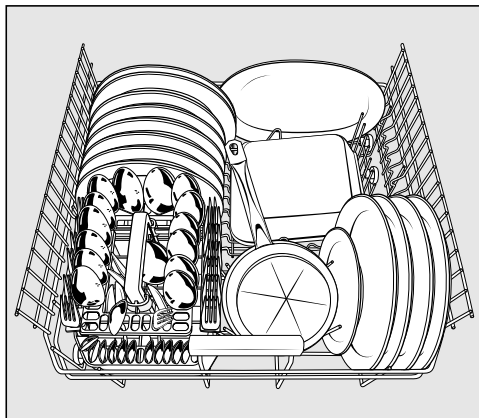
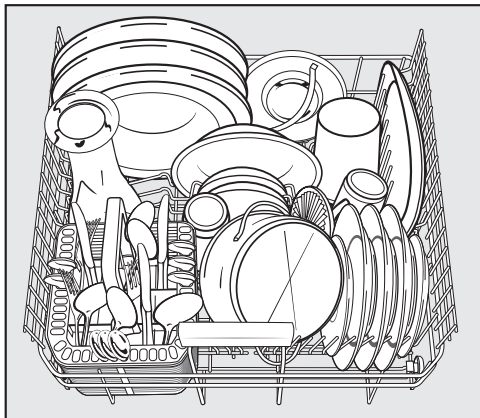

Loading the dishwasher

Cutlery basket

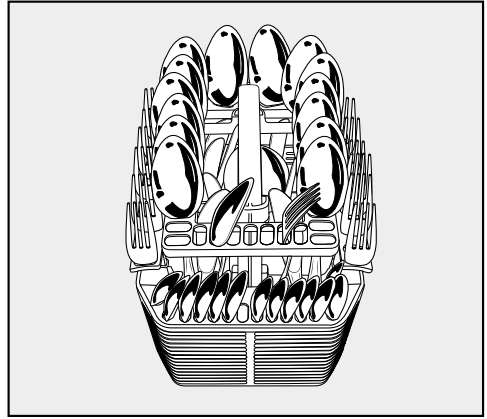
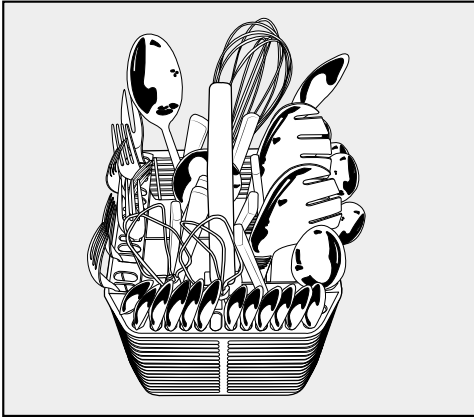

Heavily soiled items

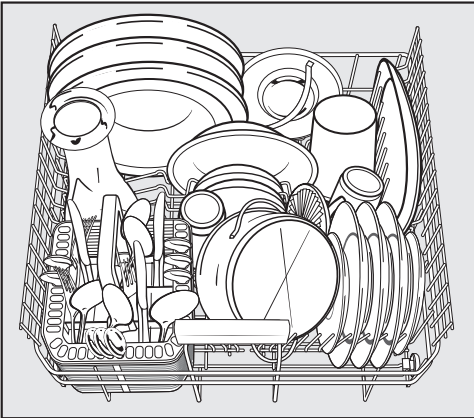

Comparison tests

Standard height with cutlery tray

Test standard: AS/NZS 2007.1:2005, AS/NZS 2007.2:2005;
AS/NZS 6400:2005

Standard programme ECO
for energy label comparison
tests:

Capacity: 🍴 | 14 place settings

Detergent quantity: 32.5 g in Compartment II

Rinse aid dispensing: Setting 3

You can find information on adjusting the rinse aid dosage in the "Rinse aid" section of this booklet.

Drying measurements: Door ajar using a block of approximately 50 mm upon completion of dry test.

Upper basket level:

Position: Bottom

Jumbo cup rack
(if available): Outer position

Loading examples

Pictures illustrating how to load the dishwasher are shown on the following pages.

Picture ①: Upper basket

Picture ②: Lower basket

Picture ③: Cutlery tray

Do not lower or remove the basket inserts.

Remove the bottle holder from the lower basket
(if available).

Capacity

14

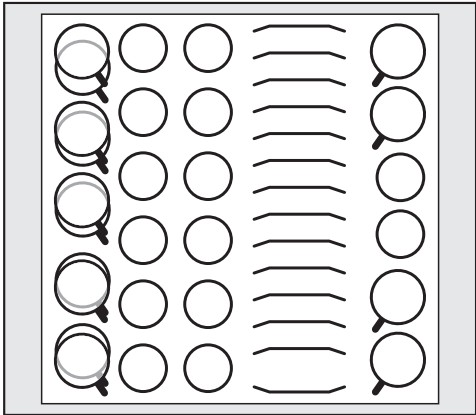

1

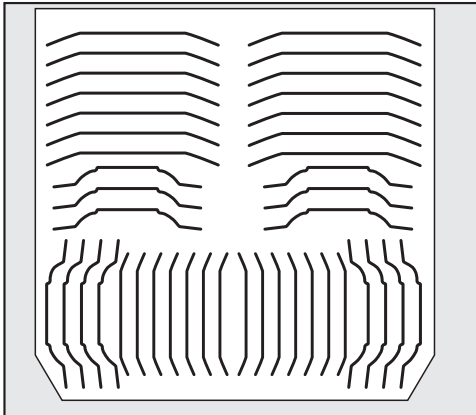

2

Comparison tests

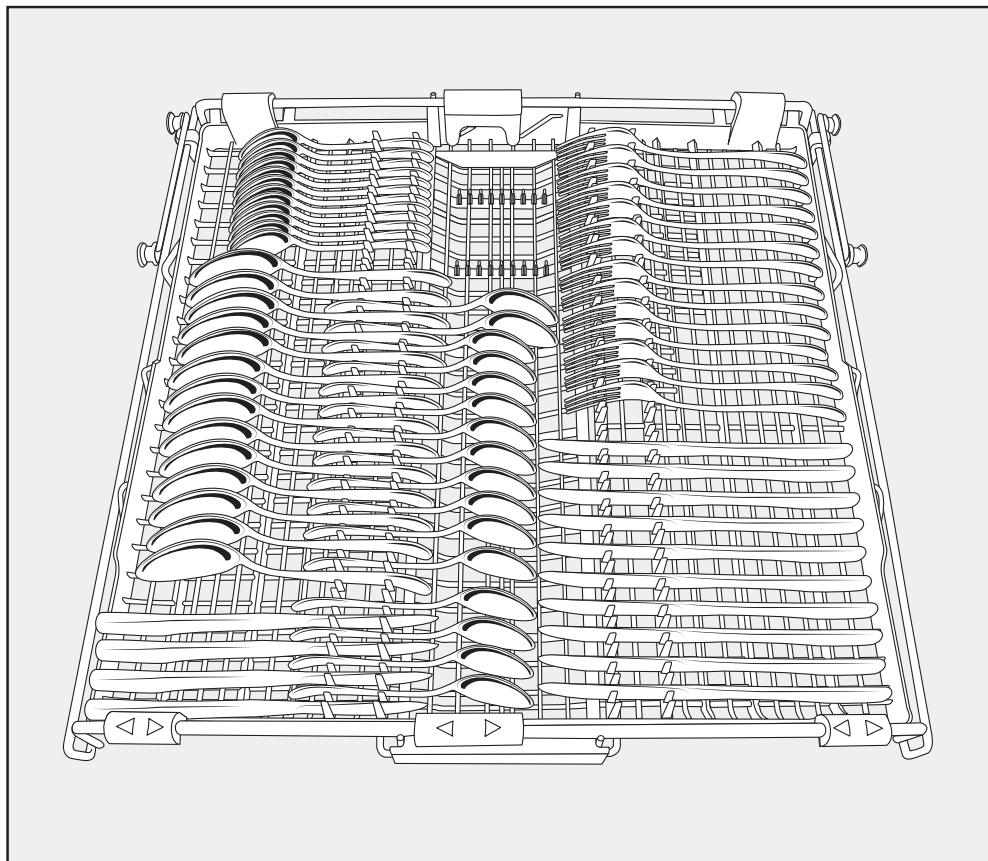

③

XXL height with cutlery tray

Test standard: AS/NZS 2007.1:2005, AS/NZS 2007.2:2005;
AS/NZS 6400:2005

Standard programme ECO
for energy label comparison
tests:

Capacity: 🍴 | 15 place settings

Detergent quantity: 33.7 g in Compartment II

Rinse aid dispensing: Setting 3

You can find information on adjusting the rinse aid dosage in the "Rinse aid" section of this booklet.

Drying measurements: Door ajar using a block of approximately 50 mm upon completion of dry test.

Upper basket level:

Position: Bottom

Jumbo cup rack
(if available): Outer position

Loading examples

Pictures illustrating how to load the dishwasher are shown on the following pages.

Picture ①: Upper basket

Picture ②: Lower basket

Picture ③: Cutlery tray

Do not lower or remove the basket inserts.

Remove the bottle holder from the lower basket
(if available).

Comparison tests

Capacity

☞ 15

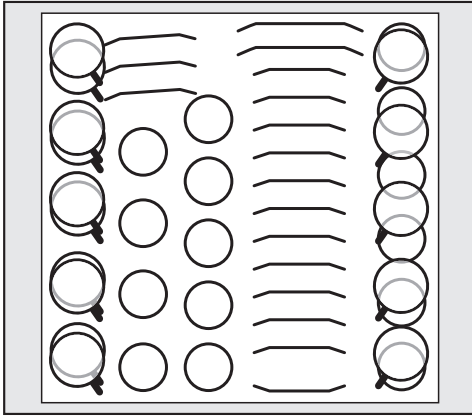

①

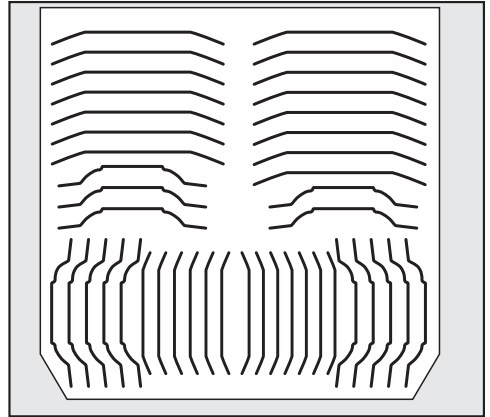

②

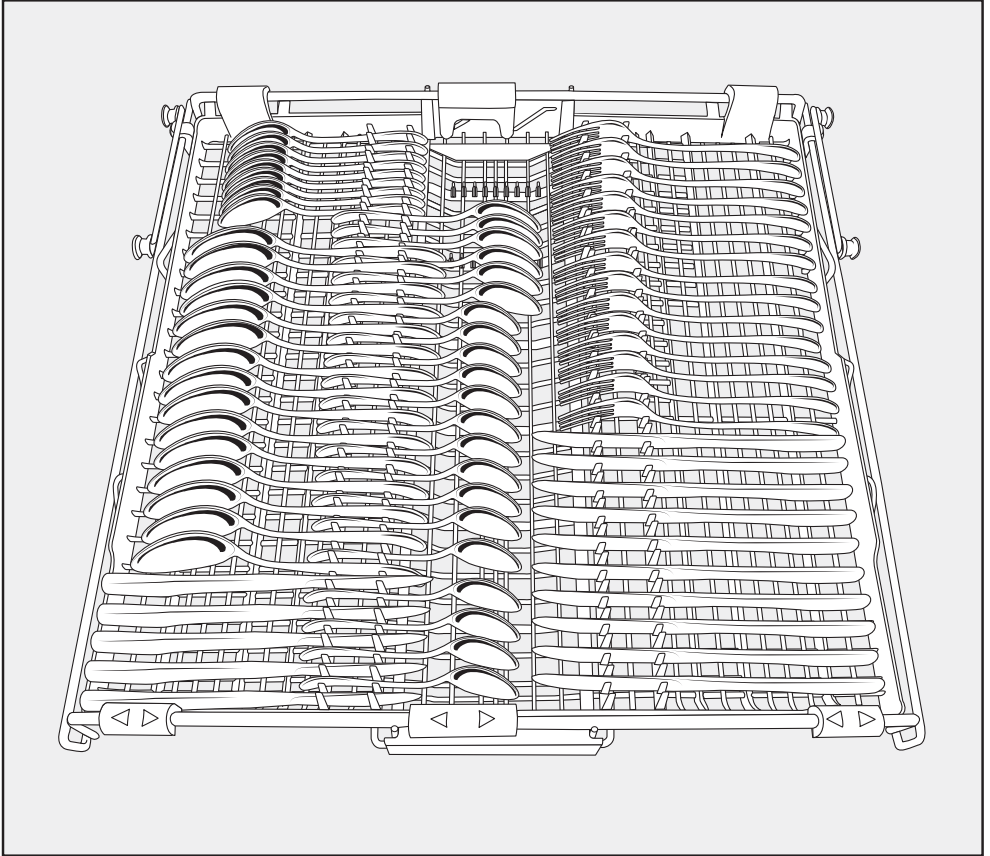

③

Comparison tests

Standard and XXL height with cutlery basket

Test standard: AS/NZS 2007.1:2005, AS/NZS 2007.2:2005;
AS/NZS 6400:2005

Standard programme ECO
for energy label comparison
tests:

Capacity: 🍴🍴 | 14 place settings

Detergent quantity: 5.0 g in Compartment I,
27.5 g in Compartment II

Rinse aid dispensing: Setting 5

You can find information on adjusting the rinse aid dosage in the "Rinse aid" section of this booklet.

Drying measurements: Door ajar using a block of approximately 50 mm upon completion of dry test.

Upper basket level:

Position: Bottom

Jumbo cup rack
(if available): Outer position

Loading examples

Pictures illustrating how to load the dishwasher are shown on the following pages.

Picture ①: Upper basket

Picture ②: Lower basket

Picture ③: Cutlery basket

Do not lower or remove the basket inserts.

Remove the bottle holder from the lower basket
(if available).

Capacity

☞ 14

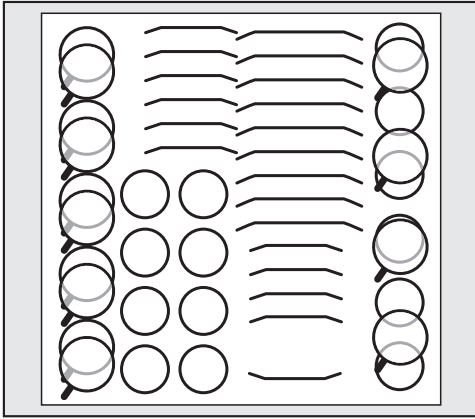

Upper basket

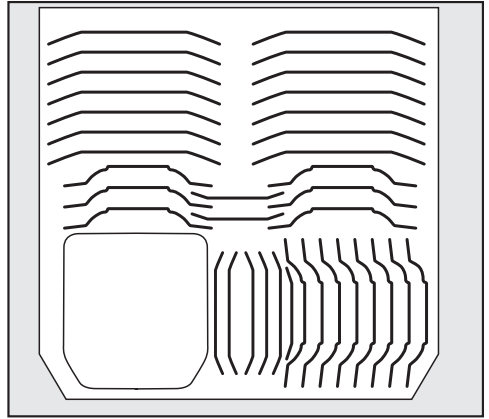

Lower basket

Comparison tests

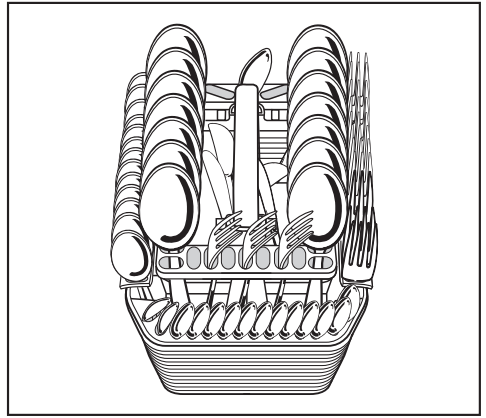
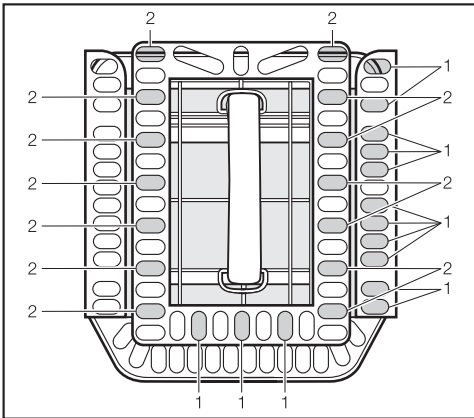
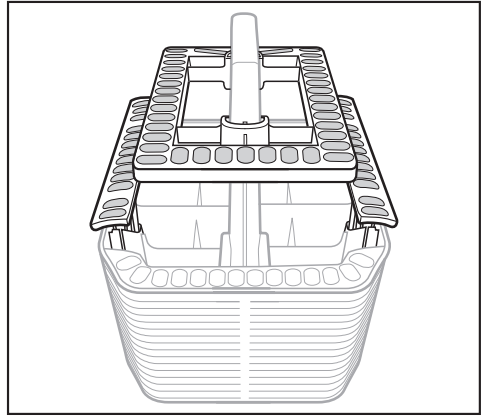
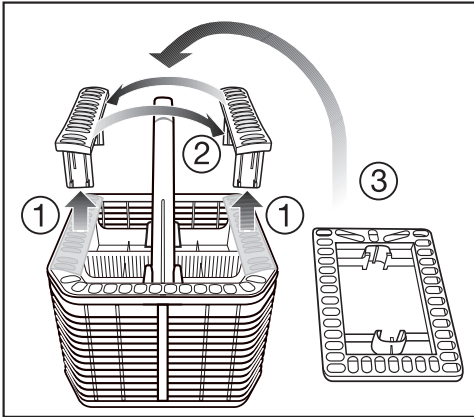

Cutlery basket

1 fork

2 soup spoons

Detergent

 Only use detergents formulated for domestic dishwashers. Do not use washing-up liquid.

Active ingredients

Modern detergents contain various active ingredients, the most important of which are:

- Complexing agents to prevent calcification.
- Alkalis to aid the removal of dried on soiling.
- Enzymes to break down starch and loosen protein.
- Oxygen based bleaching agents to remove coloured stains (e.g. tea, coffee, tomato sauce).

Most dishwasher detergents are mildly alkaline and contain enzymes and oxygen based bleaching agents.

Types of detergent:

- Powder and liquid gel detergents. These detergents allow you to adjust the amount dispensed according to the amount of load and level of soiling.
- Tab detergents. These are suitable for most levels of soiling.

You can also buy combination products (see "Programme options - DetergentAgent", if applicable). In addition to detergent, these products contain rinse aid and salt substitutes. They are available as "3 in 1" or when they also contain other components such as glass and stainless steel protective additives and enhanced cleaning power, as "5 in 1", "7 in 1", "All in 1" etc.

Refer to the manufacturer's packaging as to whether combination products are suitable for the water hardness level in your area.

Please note that the cleaning and drying results of combination detergents can vary greatly.

For optimum cleaning and drying results, use Miele dishwasher detergent and add Miele salt and Miele rinse aid separately. See "Optional accessories".

Operation

Detergent dosage

- Follow the dosage recommended by the manufacturer on the packaging.
- Unless directed otherwise, use one detergent tab or add 20 to 30 ml detergent to compartment II, depending on the level of soiling. With very heavy soiling you can also add a small amount of detergent to compartment I.
- Tabs may not dissolve completely when the Quick wash programme (if available) is used.

Failure to dispense the recommended amount of detergent may impair cleaning results.

 Some dishwasher detergents are strongly alkaline and contain irritant or corrosive ingredients. They can be extremely dangerous if swallowed and can cause burning in the nose, mouth and throat or inhibit breathing.

Avoid inhalation of powder detergents and do not ingest dishwasher detergent. Seek medical advice immediately if detergent has been swallowed or inhaled.

Keep detergent and other household agents out of the reach of children at all times. Keep children away from the dishwasher when the door is open. There could still be detergent residues in the cabinet. Check that the detergent dispenser is empty at the completion of a programme. To avoid the danger of children coming into contact with the dishwasher detergent, only add detergent just before starting the programme and close the door, activating the safety lock (if your dishwasher is fitted with one).

Adding detergent

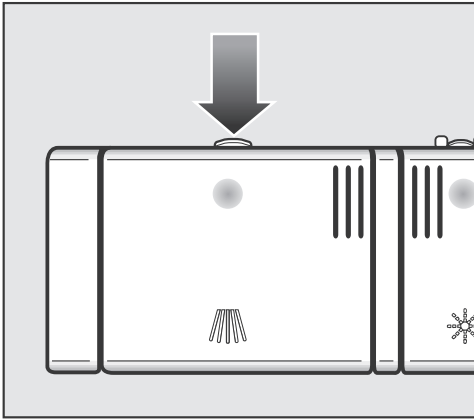

- Press the opening catch on the detergent dispenser. The flap will spring open.

The flap is always open at the end of a programme.

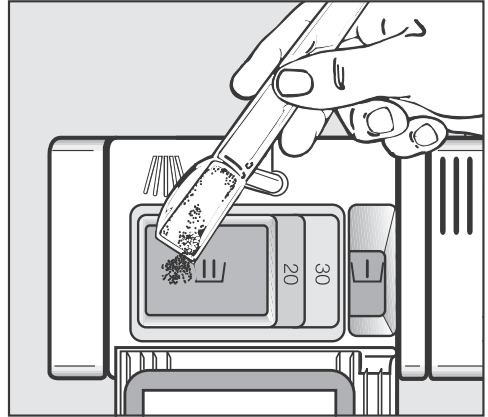

- Add the required amount of detergent and close the flap.
- Make sure that the detergent packaging is properly closed after use to avoid it getting damp and becoming lumpy.

For information



Compartment I holds max. 10 ml,
Compartment II holds max. 50 ml.

There are marks in Compartment II to assist with dispensing: 20, 30. The marks indicate a level of approx. 20 or 30 ml when the door is open in a horizontal position.

Operation

Switching on the dishwasher

- Make sure the spray arms are not obstructed.
- Close the door.
- Turn on the tap if it is turned off.
- Switch the dishwasher on with the ① button.

The / indicator light flashes and the indicator light comes on next to the programme selected.

Selecting a programme

Choose your programme according to the type of load and how dirty it is.

The different programmes and their uses are described in the **Programme chart** later on in this booklet.

- Use the programme selector button  to select the programme required.

The indicator light for the programme selected will light up.

The programme duration will appear in hours and minutes in the display.



You can now select programme options (see "Programme options").

If any programme options are selected, the appropriate indicator lights will light up.

Starting the programme

■ Press the / button.

The programme will begin.

The / indicator light comes on.

A programme should only be cancelled in the first few minutes, if at all. Otherwise important programme stages could be omitted.

Display

The duration of the programme selected appears in hours and minutes in the display before the programme begins. During the programme the time left until the end of the programme is displayed.

The programme duration displayed may vary with the same programme. It is influenced by, among other things, the water temperature at each intake, the reactivation process, the type of detergent, the amount of crockery and how dirty it is.

When a programme is selected for the first time, the display shows an average time for a cold water intake.

The times shown in the Programme chart refer to standard test loads and temperatures.

Each time a programme is run, the electronic unit takes the new conditions into account, and calculates the time required.

Operation

Energy management

To save energy, the dishwasher will switch off automatically 10 minutes after the last time a button has been pressed or 10 minutes after the end of the programme (see "Programme options - Optimise standby").

- Press the ⓘ button to switch the dishwasher back on.

The dishwasher will not switch off whilst a programme is running, during the Delay start period or if there is a fault.

Programme finished

The programme has ended when 0.00 appears in the display.

The drying fan may continue to run for a few minutes at the end of the programme.

- The dishwasher can now be opened and unloaded (see "Unloading the dishwasher").

 To prevent the risk of steam damage to the worktop edging above the dishwasher, it is advisable to leave the door closed until you are ready to unload the crockery. Alternatively, you can open the door fully until the crockery is cool enough to unload. Do not leave the door only partially open.

Switching off

At the end of a programme:

- The dishwasher can be switched off at any time using the ⏻ button.

Switching the dishwasher off during a programme stops the programme.

Switching the dishwasher off during the run-up to a Delay start time will also stop the process.

If the dishwasher is not going to be used for a longer period of time, e.g. whilst on holiday, the tap should be turned off.

Unloading the dishwasher

Dishes tend to break and chip more easily when they are hot. Allow the dishes to cool until they are comfortable enough to handle before unloading them.

If you open the door fully after switching off, the dishes will cool much faster.

First unload the lower basket, then the upper basket and finally the cutlery tray (depending on model).

This will prevent water drops from the upper basket and cutlery tray from falling onto the dishes in the lower basket.

Operation

Interrupting a programme

A programme is interrupted as soon as the door is opened.

If the door is closed again, the programme will continue from the point it was at before the door was opened.



 Water in the dishwasher may be hot. Danger of scalding!

Only open the door if absolutely necessary and exercise extreme caution when doing so. Before closing the door again, leave it ajar for approx. 20 seconds. This will enable the temperature in the wash cabinet to settle. Then raise the door up and push until the catch engages.

Changing a programme

If the detergent dispenser flap has already opened, do not change the programme.

If a programme has already started and you wish to change it, proceed as follows:

- Press and hold the / button for at least one second.

The programme will be cancelled.

- Select the programme you want, and then start it.

Turbo

The *Turbo* option reduces the duration of programmes in which this option is available.

In order to achieve optimum cleaning results, consumption rates are increased with this option.

- Switch the dishwasher on with the  button.

The / indicator light will flash.

- Select a programme.
- Press the *Turbo* button.

The *Turbo* indicator light comes on.

- The programme can now be started.

The option selected will remain active for all programmes until the setting is changed.

DetergentAgent

For optimum cleaning results, the dishwasher automatically adjusts the programme sequence to the type of detergent being used. Depending on the programme, this can mean that the running time and energy consumption vary slightly.

Programme options

Switching off the refill indicators

If you only ever use multi-function combination products in your dishwasher, you can switch the refill reminders for salt and rinse aid off if you wish. Doing so will not affect the DetergentAgent function.

- Switch the dishwasher off with the ① button, if it is switched on.
- Press the ◊/▽ button in and, **whilst holding it in**, switch the dishwasher on using the ① button. Keep the ◊/▽ button pressed in for at least four seconds until the ◊/▽ indicator light comes on.

If this does not happen, start the procedure from the beginning again.

- Press the ◊ button nine times.

The ◊ indicator light will flash rapidly nine times at intervals.

The flashing sequence in the display will show whether the refill indicators are switched on or off.

- P 1: Refill indicators are switched on.
- P 0: Refill indicators are switched off.
- Press the ◊/▽ button to change the setting.

The setting is now stored in memory.

- Switch the dishwasher off with the ① button.

If you switch to using detergent that does not contain salt or rinse aid, it is important to remember to add dishwasher salt and rinse aid and to switch the reminders back on.



Delay start

You can set the start time for a programme, e.g. to take advantage of night time electricity tariffs. The start time can be delayed between 30 minutes and 24 hours.

The delay period is shown in 30 minutes increments for a delay period between 30 minutes and 9 hours 30 minutes. It is shown in hours for periods longer than this.

When using the Delay start function, make sure that the detergent compartment is dry before adding detergent. Wipe dry with a cloth if necessary. If the compartment is wet, powder detergent can become lumpy and stick to the dispenser, with the result that it is not fully dispensed.

Do not use liquid detergent when selecting Delay start, as it can run into the dishwasher before it is required.

 To prevent children coming into contact with dishwasher detergent: Add the detergent **immediately before** starting the programme, i.e. before activating Delay start with the  button. Then lock the door with the safety lock.



- Switch the dishwasher on with the  button.

The / indicator light will flash.

- Select the required programme.
- Press the  button.

The last Delay start time used will appear in the display. The Delay start indicator light  comes on.



- Set the required time using the  button.

If you keep the  button pressed in, the time will increase automatically up to 24 hours. To get back to 0.30 hours, press the  button twice.

- Press the / button.

The / indicator light comes on.

Programme options

If "Optimise standby" is switched on (see "Programme options - Optimise standby"), the display will go out after a few minutes, leaving just the / indicator light flashing slowly.

Press any button to switch the display back on again for a few minutes.

The time up until the programme starts will show counting down in the display in hours for durations above 10 hours, and in minutes for durations below this.

When the set time is reached, the programme selected will start automatically. The time remaining will appear in the display and the  indicator light will go out.

How the Delay start time is shown in the display:

up to 59 minutes:

e.g. 30 minutes = *0.30*

1 hour up to 9 hours 30 minutes:

e.g. 5 hours = *5.00*



10 hours and over:



e.g. 15 hours = *15*

Starting a programme before the Delay start period has elapsed:



A programme can be started before the Delay start period has elapsed.

Proceed as follows:

- Press and hold the / button for at least one second.

The  indicator light goes out and the / indicator light begins flashing.

- Press the / button again.

The programme will begin and the / indicator light will light up.

Adjust Sensor wash

You can adjust the *Sensor wash* programme so that it will remove stubborn soiling in a lightly soiled load.

- Switch the dishwasher off with the ① button, if it is switched on.
- Press the ◀/▽ button in and, **whilst holding it in**, switch the dishwasher on using the ① button. Keep the ◀/▽ button pressed in for at least four seconds until the ◀/▽ indicator light comes on.

If this does not happen, start the procedure from the beginning again.

- Press the ◀ button five times.

The ◀ indicator light will flash rapidly five times at intervals.

The flashing sequence in the display indicates whether "Adjust sensor wash" is activated or not.

- P 1: "Adjust sensor wash" is switched on.
- P 0: "Adjust sensor wash" is switched off.

- Press the ◀/▽ button to change the setting.

The setting is now stored in memory.

- Switch the dishwasher off with the ① button.

Programme options







Optimise standby

"Optimise standby" is activated by default.

To save energy, the dishwasher will switch off automatically a few minutes after the last time a button has been pressed or after the end of a programme.

The dishwasher will not switch off whilst a programme is running, during the Delay start period or if there is a fault.

"Optimise standby" can be switched off if you prefer. If you do this, the duration before the dishwasher switches off increases to 6 hours. Doing this will increase energy consumption.

- Switch the dishwasher off with the ① button, if it is switched on.
- Press the / button in and, **whilst holding it in**, switch the dishwasher on using the ① button. Keep the / button pressed in for at least four seconds until the / indicator light comes on.



If this does not happen, start the procedure from the beginning again.

- Press the  button eight times.

The  indicator light will flash rapidly eight times at intervals.

The flashing sequence in the display shows whether Optimise standby is activated or not.

- P 1: "Optimise standby" is switched on.
- P 0: "Optimise standby" is switched off.

- Press the / button to change the setting.

The setting is now stored in memory.

- Switch the dishwasher off with the ① button.

Factory default settings

If you have altered any settings from the factory default, you can reset them back to the factory default settings as follows:

- Switch the dishwasher off with the ① button, if it is switched on.
- Press the ◀/▽ button in and, **whilst holding it in**, switch the dishwasher on using the ① button. Keep the ◀/▽ button pressed in for at least four seconds until the ◀/▽ indicator light comes on.

If this does not happen, start the procedure from the beginning again.

- Press the ◀ button 12 times.

The ◀ indicator light will do 1 long flash and 2 short flashes at intervals.

The flashing sequence in the display indicates whether a setting has been changed from its factory default.

- P 1: All settings are set to factory default settings.
- P 0: At least one setting has been changed.

- To reset the dishwasher to the factory default settings, press the ◀/▽ button.

The setting is now stored in memory.

- Switch the dishwasher off with the ① button.

Programme chart

Programme	Programme sequence				
	Pre-wash	Main wash °C	Interim rinse	Final rinse °C	Drying
Sensor wash	Variable programme sequence, sensor-controlled adjustment according to amount of crockery and soiling				
	If required	47-55	If required	65	X
Gentle 45°C ☺	X	44	X	65	X
ECO ¹⁾	X	50		50	X
Light soiling 50°C	X	50	X	68	X
Pots & pans 75°C	2X	75	X	68	X

¹⁾ This programme is the most efficient in terms of its combined energy and water consumption for cleaning normally soiled crockery.

Programme chart

Consumption ²⁾			Duration ²⁾	
Electricity		Water		
Cold water kWh	Hot water kWh	Litres	Cold water h:min	Hot water h:min
0.85 ³⁾ -1.35 ⁴⁾	0.65 ³⁾ -0.90 ⁴⁾	13.5 ³⁾ -16.0 ⁴⁾	1:30-2:50	1:25-2:40
1.05	0.60	19.0	1:48	1:38
0.88 ⁵⁾ / 0.85	0.37 ⁵⁾ / 0.38	14.0	2:22 ⁵⁾ / 2:29 ⁶⁾	2:11 ⁵⁾ / 2:23
1.45	0.75	19.0	2:04	1:56
1.60	1.10	15.0	2:47	2:37

²⁾ Values quoted are in accordance with EN 50242. In practice there may be variations to these figures due to variable conditions and data recorded by the sensors. The durations displayed in your dishwasher will reflect your household conditions.

Selecting programme options will also affect consumption levels and programme durations (see "Programme options").

- ³⁾ Part load with light soiling
- ⁴⁾ Full load with heavy soiling
- ⁵⁾ Dishwashers with cutlery basket
- ⁶⁾ Dishwashers with cutlery tray

Programme chart

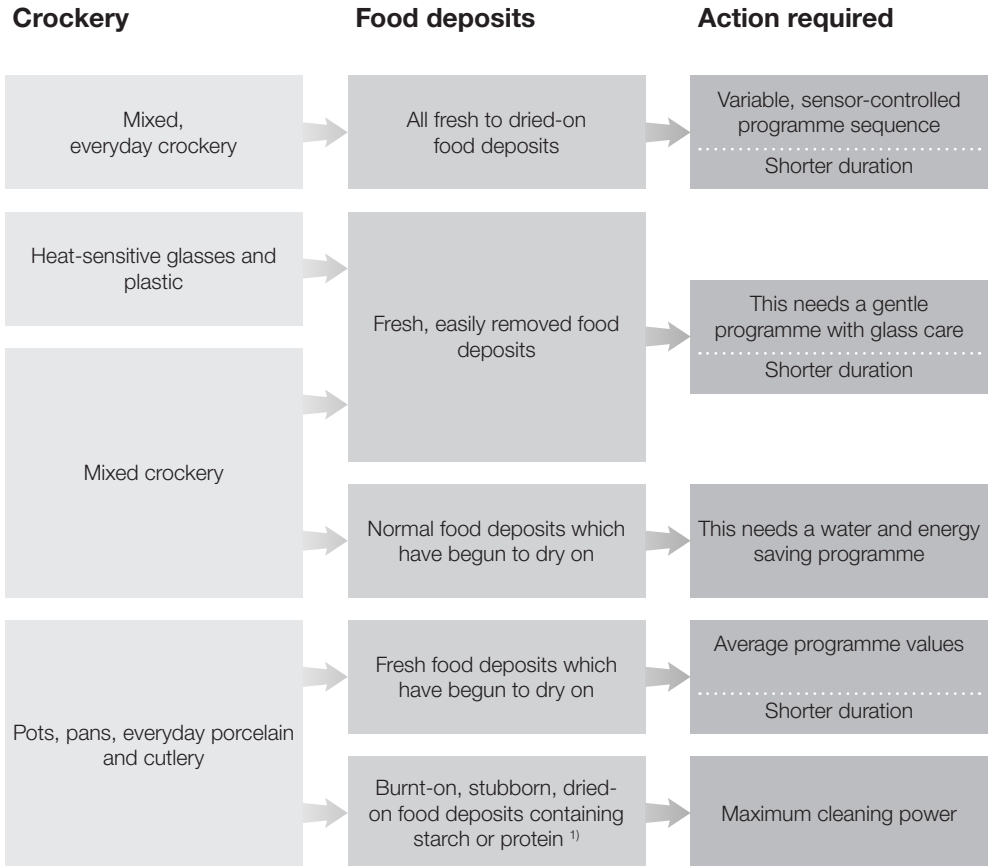

¹⁾ Food such as potatoes, pasta, rice or stews can leave starchy deposits. Deposits containing protein can be left by food such as fried meat, fish or eggs and bakes.

Programme chart

Programme	Detergent	
	Compartment I ²⁾	Compartment II ²⁾
Sensor wash ----- +Turbo	-	25 ml or 1 tab
Gentle 45°C  ----- +Turbo	-	20 ml or 1 tab
ECO	-	25 ml or 1 tab
Light soiling 50°C ----- +Turbo	-	25 ml or 1 tab
Pots & pans 75°C	10 ml	25 ml or 1 tab

²⁾ see "Detergent"

Cleaning and care

Check your dishwasher regularly (approx. every 4-6 months). This way faults and problems can be avoided.

 The external surfaces of this appliance are all susceptible to scratching.

Contact with unsuitable cleaning agents can alter or discolour the external surfaces.

Cleaning the wash cabinet

The wash cabinet is largely self-cleaning, provided that the correct amount of detergent is always used.

If, however, there are limescale or grease deposits in the cabinet, these can be removed with a special dishwasher cleaner (see "Optional accessories"). Follow the instructions on the packaging.

Using mainly low temperature programmes (below 50°C), could cause bacteria and unpleasant odours to build up in the wash cabinet. To avoid this, the *Pots & pans* 75°C programme should be run once a month.

- Clean the filters in the wash cabinet regularly.

Cleaning the door and the door seal

Mould could build up on the door seal and the sides of the dishwasher door as these surfaces are outside the wash cabinet and are not accessed and cleaned by the spray arm jets.

- Wipe the door seals regularly with a damp cloth to remove food deposits.
- Wipe off any food or drink residues which may have dripped onto the sides of the dishwasher door before closing it.

Cleaning the door front

 Soiling that is left too long might become impossible to remove and could cause external surfaces to alter or discolour.
Remove any soiling immediately.

- Clean the front with a solution of warm water and a little washing-up liquid applied with a soft sponge. Wipe the surfaces dry using a soft cloth.
For cleaning, you can also use a clean, damp microfibre cloth, such as the Original Miele all purpose microfibre cloth, without any cleaning agent.

To avoid damaging external surfaces, do not use:

- cleaning agents containing soda, ammonia, acids or chlorides,
- cleaning agents containing descaling agents,
- abrasive cleaning agents, e.g. powder cleaners and cream cleaners,
- solvent-based cleaning agents,
- stainless steel cleaning agents,
- dishwasher cleaner,
- oven cleaner,
- glass cleaning agents,
- hard, abrasive brushes or sponges, e.g. pot scourers, brushes or sponges which have been previously used with abrasive cleaning agents,
- dirt erasers,
- sharp metal scrapers,
- steel wool or metal scourers,
- steam cleaning appliances.

Cleaning and care

Checking the filters in the wash cabinet

The filter combination in the base of the wash cabinet retains coarse soil from the suds solution, preventing it accessing the circulation system and re-entering the cabinet through the spray arms.

⚠ This dishwasher must not be used without all the filters in place.

Collection of coarse soil may cause the filters to clog. The level of soiling and time it takes before the filters need cleaning will vary depending on use.

- Check the condition of the filters regularly and clean them if necessary.

Cleaning the filters

- Switch the dishwasher off.

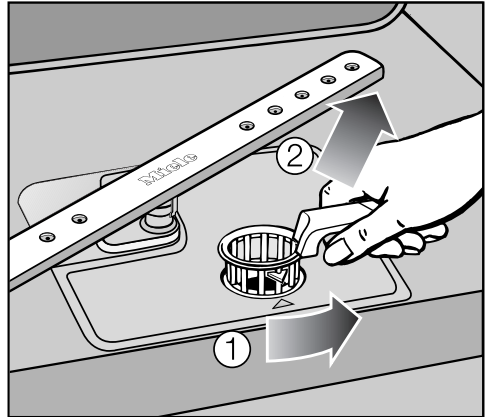

- Turn the handle anti-clockwise to release the filter combination ①.
- Lift the filter combination out of the dishwasher ②. Remove any coarse particles and rinse the filter well under running water. Use a nylon brush if necessary.

⚠ During cleaning ensure that coarse soil doesn't get into the circulation system and cause a blockage.

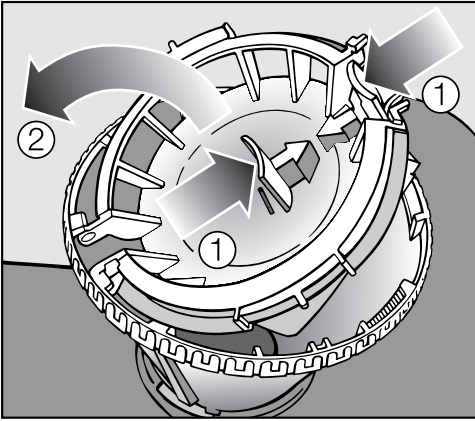

To clean the inside of the filter, the flap must be opened:

- Press the catches ① together in the direction of the arrows as shown, and open the filter ②.
- Rinse all the filters under running water.
- Then close the flap so that the catch engages.

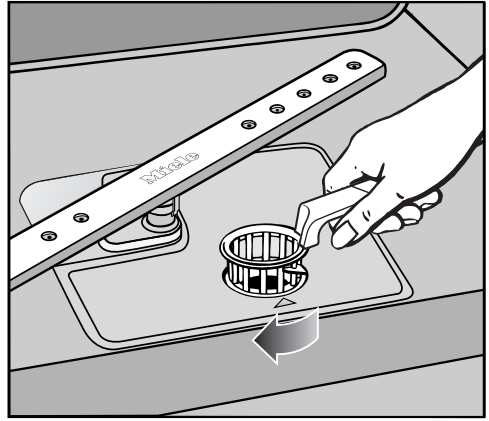

- Replace the filter combination so that it lies flat in the base of the wash cabinet.
- Then turn the handle clockwise until both arrows point towards each other. This will lock the filter combination in place.

⚠ Take care when you are fitting the filter combination that it is secured in position correctly. Otherwise coarse soil could get into the circulation system and cause a blockage.

Cleaning and care

Cleaning the spray arms

Particles of food can get stuck in the spray arm jets and bearings. The spray arms should therefore be inspected and cleaned regularly (approx. every 4 - 6 months).

- Switch the dishwasher off.

Remove the spray arms as follows:

- Take out the cutlery tray (if your dishwasher is fitted with one).
- Push the **top** spray arm upwards to engage the inner ratchet. Then unscrew the spray arm.

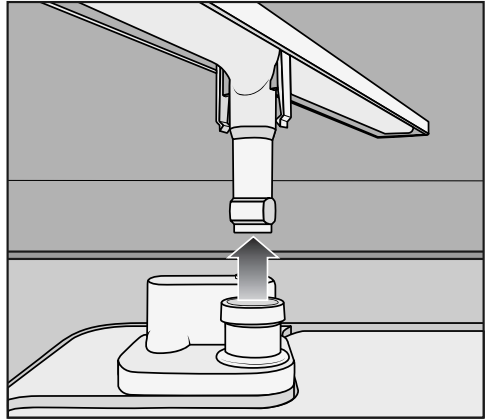

- Pull the **lower** spray arm firmly upwards to remove it.

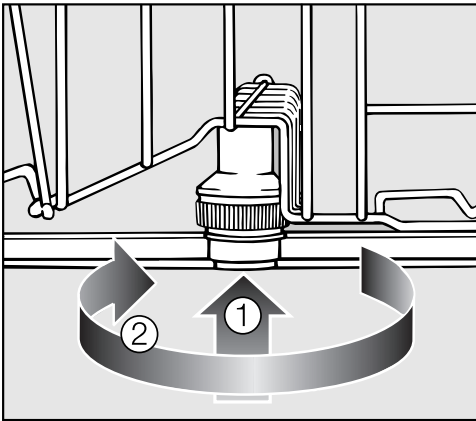

- Push the **middle** spray arm upwards ① to engage the ratchet. Then unscrew the spray arm ②.
- Remove the lower basket.

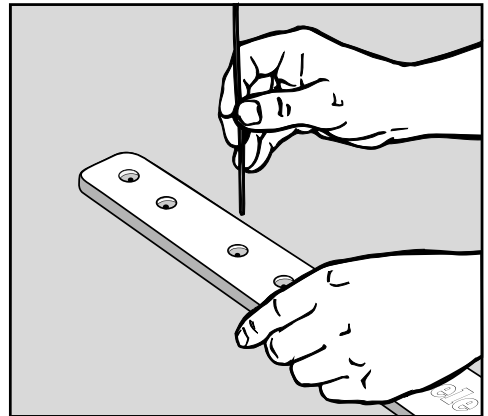

- Use a pointed object to push food particles into the spray arm jets.
- Rinse thoroughly under running water.
- Refit the spray arms and check that they rotate freely.



With the help of the following guide, minor faults in the performance of the appliance, some of which may result from incorrect operation, can be put right without contacting Miele. This will save time and money.

Please note that a call-out charge will be applied to unnecessary service visits where the problem could have been rectified as described in these operating instructions.





 Unauthorised or incorrect repairs could cause personal injury or damage to the appliance.

Repair work to electrical appliances must only be carried out by a suitably qualified and competent person in strict accordance with current local and national safety regulations. The manufacturer cannot be held liable for unauthorised work.

Technical problems

Problem	Possible cause and remedy
The / indicator light does not flash after the dishwasher has been switched on using the  button.	The appliance is not plugged in. <ul style="list-style-type: none">■ Insert the plug and switch on at the socket.
	The mains fuse has tripped. <ul style="list-style-type: none">■ Reset or replace the circuit breaker (see data plate for minimum fuse rating).
The dishwasher stops during a programme.	The mains fuse has tripped. <ul style="list-style-type: none">■ Reset or replace the circuit breaker (see data plate for minimum fuse rating).■ If the mains fuse trips again, call Miele.

Problem solving guide

Problem	Possible cause and remedy
<p>The  and  indicator lights are flashing at the same time. Fault number <i>FXX</i> is visible in the display.</p>	<p>There may be a technical fault.</p> <ul style="list-style-type: none">■ Switch the dishwasher off with the  button.■ Switch the dishwasher back on after a few seconds.■ Select the required programme.■ Press the / button. <p>If the indicator lights flash again, there is a technical fault.</p> <ul style="list-style-type: none">■ Call Miele.
<p>Fault <i>F70</i>: The drain pump is still running, even with the door open.</p>	<p>The Waterproof system has reacted.</p> <ul style="list-style-type: none">■ Turn off the tap.■ Call Miele.

Water inlet fault

Problem	Possible cause and remedy
The ㉸/㉹ indicator light flashes on and off.	The tap is turned off. <ul style="list-style-type: none"> ■ Turn on the tap fully.
The dishwasher stops during a programme. The ㉸/㉹ indicator light flashes. Fault code F12 or F13 appears in the display.	Before rectifying the problem, you must: <ul style="list-style-type: none"> ■ Switch the dishwasher off with the ㉺ button. Water intake is restricted. <ul style="list-style-type: none"> ■ Turn on the tap fully and start the programme again. ■ Clean the water inlet filter (see "Maintenance"). ■ The water pressure at the intake is lower than 30 kPa (0.3 bar). Seek professional advice.

Water drainage fault

Problem	Possible cause and remedy
The dishwasher stops during a programme. The ㉸/㉹ indicator light flashes. Fault code F11 appears in the display.	Before rectifying the problem, you must: <ul style="list-style-type: none"> ■ Switch the dishwasher off with the ㉺ button. The water outlet is restricted. There might be water in the wash cabinet. <ul style="list-style-type: none"> ■ Clean the filter combination (see "Cleaning and care - Cleaning the filters"). ■ Clean the drain pump (see "Maintenance"). ■ Clean the non-return valve (see "Maintenance"). ■ Remove any kink or loop in the drain hose.

Problem solving guide

General problems

Problem	Possible cause and remedy
The indicator lights and display are dark.	<p>The dishwasher has switched off automatically to save energy.</p> <ul style="list-style-type: none"> ■ Switch the dishwasher on again with the ① button.
Detergent residue is left in the dispenser at the end of a programme.	<p>The dispenser was still damp when detergent was added.</p> <ul style="list-style-type: none"> ■ Make sure the dispenser is dry before adding detergent.
The detergent dispenser lid cannot be closed properly.	<p>Clogged detergent residue is blocking the catch.</p> <ul style="list-style-type: none"> ■ Clean the detergent from the catch.
At the end of a programme there is a film of moisture on the inside of the door and the interior walls.	<p>This is caused by the drying system and does not indicate a fault. The moisture will dissipate after a while.</p>
Water remains in the wash cabinet at the end of a programme.	<p>Before rectifying the problem you must:</p> <ul style="list-style-type: none"> ■ Switch the dishwasher off with the ① button.
	<p>The filter combination in the wash cabinet is clogged.</p> <ul style="list-style-type: none"> ■ Clean the filter combination (see "Cleaning and care - Cleaning the filters").
	<p>The drain pump or non-return valve may be blocked.</p> <ul style="list-style-type: none"> ■ Clean the drain pump or the non-return valve (see "Maintenance").
	<p>The drain hose is kinked.</p> <ul style="list-style-type: none"> ■ Remove any kink from the drain hose.

Noises

Problem	Possible cause and remedy
Knocking noise in the wash cabinet.	A spray arm is knocking against an item in a basket. ■ Interrupt the programme, and rearrange the items which are obstructing the spray arm.
Rattling noise in the wash cabinet.	Items of crockery are insecure in the wash cabinet. ■ Interrupt the programme, and rearrange the items of crockery.
	A foreign object (e.g. a cherry stone) has become lodged in the drain pump. ■ Remove the foreign object from the drain pump (see "Maintenance - Cleaning the drain pump and non-return valve").
Knocking noise in the water pipes.	This may be caused by the on-site installation or the cross-section of the piping. ■ This has no influence on dishwasher function. If in doubt, contact a suitably qualified plumber.

Problem solving guide

Unsatisfactory washing result

Problem	Possible cause and remedy
The dishes are not clean.	The dishes were not loaded correctly. ■ See notes in "Loading the dishwasher".
	The programme was not powerful enough. ■ Select a more intensive programme (see "Programme chart").
	There is some stubborn soiling although most of the crockery is only lightly soiled (e.g. with tea stains). ■ Select the "Adjust Sensor wash" programme option (see "Programme options").
	Not enough detergent was dispensed. ■ Use more detergent, or change your detergent.
	Items are blocking the path of the spray arms. ■ Rearrange the items so that the spray arms can rotate freely.
	The filter combination in the base of the wash cabinet is not clean or is not correctly fitted. This may cause the spray arm jets to get blocked. ■ Clean and/or fit the filter combination correctly. ■ Clean the spray arm jets, if necessary (see "Cleaning and care - Cleaning the spray arms").
	The non-return valve is open and blocked. Dirty water has flowed back into the wash cabinet. ■ Clean the drain pump and the non-return valve (see "Maintenance").
Smearing appears on glassware and cutlery, there is a bluish sheen on the surface of glassware; film can be wiped off.	The rinse aid dosage is set too high. ■ Reduce the dosage (see "Before using for the first time - Rinse aid").

Problem solving guide

Problem	Possible cause and remedy
Dishes, cutlery and glasses are not dry or are flecked.	The amount of rinse aid may be insufficient, or the rinse aid reservoir is empty. <ul style="list-style-type: none"> ■ Replenish the reservoir, increase the dosage or change the brand of rinse aid (see "Before using for the first time - Rinse aid").
	Crockery was taken out of the cabinet too soon. <ul style="list-style-type: none"> ■ Leave it in for longer (see "Operation").
	Combination tabs have been used which have impaired drying performance. <ul style="list-style-type: none"> ■ Change your detergent, or replenish the rinse aid (see "Before using for the first time - Rinse aid").
Glassware has a brown or blue tinge, and film cannot be wiped off.	This may be caused by the detergent. <ul style="list-style-type: none"> ■ Change your detergent.
Glassware is dull and discoloured; film cannot be wiped off.	The glassware is not dishwasher-proof. The surfaces are affected. <ul style="list-style-type: none"> ■ There is no remedy. Purchase glassware which is dishwasher-proof.
Tea or lipstick stains have not been completely removed.	The wash temperature of the selected programme was too low. <ul style="list-style-type: none"> ■ Select a programme with a higher wash temperature.
	The bleaching effect of the detergent used is too low. <ul style="list-style-type: none"> ■ Change your detergent.
Plastic items are discoloured.	Natural dyes e.g. from carrots, tomatoes or tomato sauce may be the cause. The amount of detergent used or its bleaching effect was not sufficient to deal with natural dyes. <ul style="list-style-type: none"> ■ Use more detergent (see "Operation - Detergent"). Discolouration is irreversible.

Problem solving guide

Problem	Possible cause and remedy
<p>White residue is visible on cutlery and crockery, clouding occurs on glassware; film can be wiped off.</p>	<p>Not enough rinse aid was used.</p> <ul style="list-style-type: none"> ■ Increase the dosage (see "Before using for the first time - Rinse aid").
	<p>There is no salt in the salt reservoir.</p> <ul style="list-style-type: none"> ■ Fill the salt reservoir (see "Before using for the first time - Dishwasher salt").
	<p>The salt reservoir cap has not been screwed on correctly.</p> <ul style="list-style-type: none"> ■ Replace it, making sure that it screws back on correctly.
	<p>An unsuitable combination detergent has been used.</p> <ul style="list-style-type: none"> ■ Change your detergent. Use a standard liquid, tablet or powder detergent, and fill the salt and rinse aid reservoirs in the dishwasher.
	<p>The water softener is programmed to too low a water hardness level.</p> <ul style="list-style-type: none"> ■ Programme the water softener for harder water (see "Before using for the first time - Water softener").
<p>There are rust stains on cutlery.</p>	<p>The affected items are not corrosion resistant.</p> <ul style="list-style-type: none"> ■ There is no remedy. Purchase cutlery which is dishwasher-proof.
	<p>A programme was not run after dishwasher salt was added. Traces of salt have got into the wash cycle.</p> <ul style="list-style-type: none"> ■ Always run the <i>Gentle 45°C</i>  programme with the <i>Turbo</i> programme option selected and without any crockery in the dishwasher after adding dishwasher salt.
	<p>The salt reservoir cap has not been screwed on correctly.</p> <ul style="list-style-type: none"> ■ Replace it, making sure that it screws back on correctly.

Cleaning the water inlet filter

A filter is incorporated in the screw connection of the valve on the water inlet hose. The filter must be cleaned when dirty, otherwise insufficient water flows into the wash cabinet.

⚠ The plastic housing of the water connection contains an electrical component.
The housing must not be dipped in water.

Recommendation

If the mains water contains a large amount of insoluble substances, we recommend fitting a large-area filter in the connection between the tap and the water inlet hose threaded union. This filter is available from Miele.

Cleaning the filter:

- Disconnect the dishwasher from the mains supply.
Switch off at the mains socket and withdraw the plug.
- Turn off the tap.
- Unscrew the inlet hose.

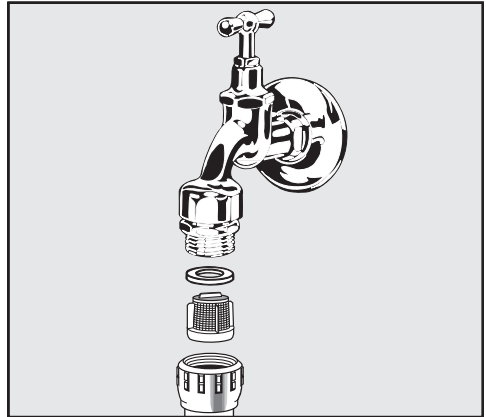

- Carefully remove the washer.
- Withdraw the filter using pointed pliers and rinse clean under running water.
- Replace the filter and washer, making sure they are sitting correctly.
- Reconnect the inlet hose to the tap, making sure it goes on correctly and is not cross-threaded.
- Turn on the tap.

If water leaks out, the inlet hose may not be connected securely or it may have been screwed on at an angle.

- Unscrew and reconnect the inlet hose correctly.

Maintenance

Cleaning the drain pump and non-return valve

If the water has not been pumped away at the end of a programme, the drain pump or the non-return valve might be blocked. They are, however, easy to clean.

- Disconnect the dishwasher from the mains supply. Switch off at the mains socket and withdraw the plug.
- Take the filter combination out of the wash cabinet (see "Cleaning and care - Cleaning the filters").
- Scoop the water out of the cabinet using a suitable container or utensil.

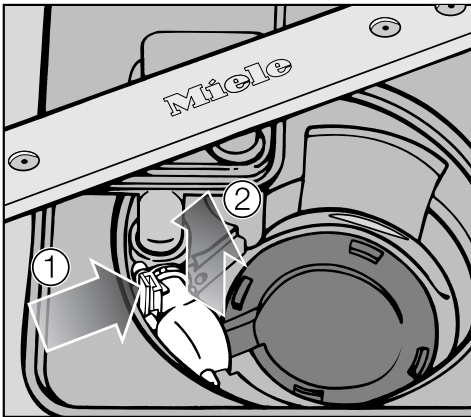

- Press the catch for the non-return valve inwards ①.
- Lift out the non-return valve ②, and rinse well under running water.
- Remove all foreign objects from the non-return valve.

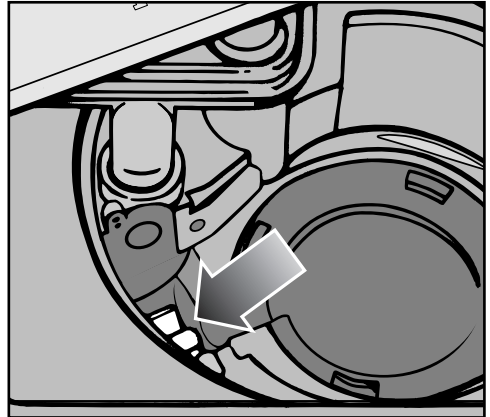

The drain pump is situated under the non-return valve (see arrow).

- Remove all foreign objects from the drain pump (watch out for glass or bone splinters which are particularly difficult to detect and could cause injury). Turn the drain pump impeller by hand to check that there are no more obstructions. You will feel a little resistance when you turn the impeller.
- Carefully refit the non-return valve and secure it with the catch.

⚠ Ensure that the catch engages correctly.

⚠ Be careful not to damage any delicate components when cleaning the drain pump and the non-return valve.

Repairs

In the event of any faults which you cannot remedy yourself, please contact Miele.

The contact details for Miele are given at the back of these instructions.

When contacting Miele, please quote the model and serial number of your dishwasher, both of which are shown on the data plate on the right-hand side of the door.

Warranty

The manufacturer's warranty for this appliance is 2 years.

For further information, please refer to your warranty booklet.

Optional accessories

Dishwasher detergent and rinse aid, as well as cleaning and care products, are available as optional accessories. All the products are designed for use with Miele dishwashers.

These and many other useful products can be ordered via the internet at www.miele-shop.com (depending on country) or from Miele (see end of this booklet for contact details).



Dishwasher detergent, rinse aid and salt

When you decided to buy a Miele dishwasher, you chose excellent quality and performance. However, ensuring that your dishwasher always delivers the best possible results will also depend on your choice of dishwasher detergent, rinse aid and dishwasher salt, as cleaning results can vary depending on the brand used. With Miele CareCollection products, you can be sure of optimum results as these products have been specially designed for Miele dishwashers.

Detergent tabs

- sparkling results even with stubborn food deposits
- combination product with other components such as rinse aid, salt and glass protection additives
- phosphate-free - safe for the environment
- water-soluble wrapping - no need to unwrap

Powder detergent

- with active oxygen for thorough cleaning
- with enzymes which are effective even in low temperature programmes
- with glass protection against corrosion

Rinse aid

- for gleaming glasses
- helps crockery to dry
- with glass protection against corrosion
- specially designed cap for precise, easy dispensing

Dishwasher salt

- prevents limescale on crockery and in the appliance
- extra coarse-grained

Dishwasher care products

Miele cleaning and care products provide optimum care for your dishwasher.

Dishwasher cleaner

- cleans the dishwasher effectively and thoroughly
- removes grease, bacteria and unpleasant odours
- ensures excellent dishwashing results

Dishwasher descaler

- removes heavy limescale deposits
- mild and gentle with natural citric acid

Dishwasher conditioner

- removes odours, limescale and light deposits
- maintains the elasticity and leak tightness of the seals

Accessories

Some accessories may be supplied as standard, depending on model.

Cappuccinatore insert

The Cappuccinatore insert can be used for cleaning the individual parts of the Miele Cappuccinatore in the dishwasher.

Cutlery basket

The cutlery basket is placed in the lower basket and can be used to wash additional items of cutlery.

Glass rail

This rail is designed to hold glasses with stems securely in the lower basket.

Electrical connection

This dishwasher is supplied with a mains cable with moulded plug ready for connection to an AC single phase supply, (230 - 240 V 50 Hz for NZ and Australia) via a suitable switched socket.

 The electrical socket must be easily accessible after the dishwasher has been installed. Do not connect the dishwasher to the mains electricity supply by an extension lead. Extension leads do not guarantee the required safety of the appliance (e.g. danger of overheating).

Do not connect the appliance solely to an inverter such as those used with an autonomous energy source e.g. **solar power**. When switched on, peak loads in the system can cause the safety switch-off mechanism to be triggered. This can damage the electronic unit. The machine must not be used with so-called **energy-saving devices** either. These reduce the amount of energy supplied to the machine, causing it to overheat.

 Before connecting the appliance, check that the connection data on the data plate (voltage, frequency, rated load and fuse rating) matches the mains electricity supply. If in any doubt, consult a qualified electrician.

The data plate is located on the right-hand side of the door.

 All electrical work must be carried out by a suitably qualified and competent person in strict accordance with current local and national safety regulations.

For extra safety, it is advisable to install a residual current device (RCD), with a trip current of 30 mA.

The Miele Waterproof system

As long as your dishwasher has been installed correctly, the Miele waterproof anti-leak system will protect you from water damage.

Connection to the water supply

⚠ Water in the dishwasher must not be used as drinking water.

⚠ **IMPORTANT** Australia and New Zealand

This appliance must be installed according to AS/NZS 3500.1. Back flow prevention is already integrated in the appliance.

- The dishwasher may be connected to a cold or hot water supply, max. 60°C.

We would only recommend connection to a hot water supply if it is economical, e.g. a solar powered supply. When connected to a hot water supply, all programmes will be carried out with hot water.

- The inlet hose is approx. 1.5 m long.
- A tap with a 3/4" male thread must be provided on site.
- Connection to the mains water supply should only be carried out by a qualified and competent person in strict accordance with national and local safety regulations. The tap should be easily accessible once the appliance has been built in.

- The water pressure (flow pressure at the take-off point) must be between 50 and 1000 kPa (0.5 and 10 bar). If the water pressure is too high, a pressure reducer valve must be fitted.

After connecting the dishwasher to the water supply, check that all plumbing connections are watertight.

⚠ To avoid any damage to the appliance, the dishwasher must only be operated when it is connected to a fully vented plumbing system.

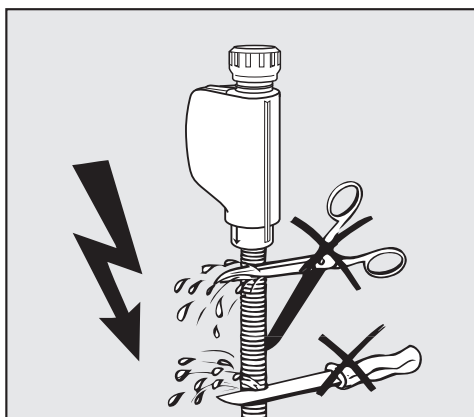

⚠ The inlet hose must not be shortened or damaged in any way as it contains electrical components (see illustration).

Water connection

Drainage

- The appliance drainage system is fitted with a non-return valve which prevents dirty water from flowing back into the dishwasher via the drain hose.
- The dishwasher is supplied with approx. 1.5 m of flexible drain hose with an internal diameter of 22 mm.
- The drain hose can be extended using a connection piece to attach a further length of hose. The drainage length must not be longer than 4 m, and the delivery head must not exceed 1 m.
- If the hose is to be directly fitted to the drainage outlet on site, use the hose clip supplied (see installation diagram).
- The hose can be directed to the left or the right of the appliance.
- The on-site connector for the drain hose can be adapted to different widths of hose. If the connector protrudes too far into the drain hose, it will need to be shortened. Otherwise the drain hose may become blocked.
- The drain hose must not be shortened.

 Make sure that there are no kinks in the hose, and that it is not squashed or stretched.

After commissioning the appliance, ensure that the water outlet does not leak.

Venting the drainage system

If the on-site drain connection is situated lower than the guide path for the bottom basket rollers in the open door, the drainage system must be vented. Otherwise a siphoning effect during a programme can cause the appliance to empty itself of water.

- To vent it: Open the dishwasher door fully.

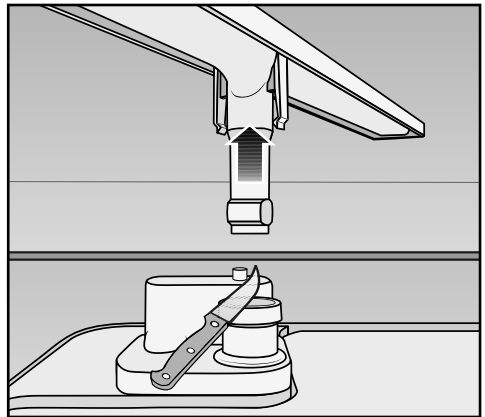

- Pull the lower spray arm firmly upwards to remove it.
- Cut off the top of the vent valve in the wash cabinet.

Technical data

Dishwasher model	Standard	XXL
Height freestanding model	84.5 cm (adjustable + 3.5 cm)	-
Height built-in model	80.5 cm (adjustable + 6.5 cm)	84.5 cm (adjustable + 6.5 cm)
Height of building-in recess	Min. 80.5 cm (+ 6.5 cm)	Min. 84.5 cm (+ 6.5 cm)
Width	59.8 cm	59.8 cm
Width of building-in recess	60 cm	60 cm
Depth freestanding model	60 cm	-
Depth built-in model	57 cm	57 cm
Weight	Max. 64 kg	Max. 56 kg
Voltage	See data plate	
Rated load	See data plate	
Fuse rating	See data plate	
Power consumption when switched off	0.20 W	0.20 W
Power consumption when not switched off	1.00 W	1.00 W
Test certificates awarded	See data plate	
Water pressure (flow rate)	50 - 1000 kPa (0.5 - 10 bar)	50 - 1000 kPa (0.5 - 10 bar)
Hot water connection	Up to max. 60 °C	Up to max. 60 °C
Delivery head	Max. 1 m	Max. 1 m
Drainage length	Max. 4 m	Max. 4 m
Mains cable	Approx. 1.7 m	Approx. 1.7 m
Capacity	14 place settings*	14/15 place settings*

* Depending on model

Miele Australia Pty. Ltd.

ACN 005 635 398
ABN 96 005 635 398

Miele Experience Centre and Head Office Melbourne:

1 Gilbert Park Drive
Knoxfield, VIC 3180

Miele Experience Centre South Melbourne:

206-210 Coventry Street
South Melbourne, VIC 3205

Miele Experience Centre and Office Sydney:

3 Skyline Place
Frenchs Forest, NSW 2086

Miele Experience Centre and Office Brisbane:

39 Harvey Street North
Eagle Farm, QLD 4009

Miele Experience Centre Gold Coast:

131 Ferry Road
Southport, QLD 4215

Miele Experience Centre and Office Adelaide:

83-85 Sir Donald Bradman Drive
Hilton, SA 5033

Miele Experience Centre and Office Perth:

205-207 Stirling Highway
Claremont, WA 6010



www.miele.com.au

Miele

Miele New Zealand Limited

IRD 98 463 631

Head Office:

Level 2, 10 College Hill
Freemans Bay, Auckland 1011

Miele Experience Centre Auckland:

8 College Hill
Freemans Bay, Auckland 1011
Telephone:
0800 464 353 (0800 4 MIELE)
www.miele.co.nz

Miele (Hong Kong) Limited

41/F - 4101, Manhattan Place
23 Wang Tai Road
Kowloon Bay, Hong Kong
Tel: (852) 2610 1331
Fax: (852)2610 1013
Email: mielehk@miele.com.hk

Miele Global Headquarters Germany

Miele & Cie. KG

Carl-Miele-Straße 29
33332 Gütersloh
Federal Republic of Germany



G 4202 / G 4203 / G 4207 / G 4208 / G 4212 / G 4217



en-AU, NZ

M.-Nr. 10 290 400 / 00