

**INSTALLATION INSTRUCTIONS
USER GUIDE**

Heat pump clothes dryer

DH8060P model

NZ AU

Fisher & Paykel



CONTENTS

Introduction	2
Safety and warnings	3
Installation instructions	6
Getting started quickly	12
Dryer controls	14
Sorting and loading	15
Drying cycles	18
Drying cycle options	19
Caring for your dryer	23
Before you call for service	26
Fault codes	27
Troubleshooting	28
Manufacturer's Warranty	34
Customer Care	36

IMPORTANT!

SAVE THESE INSTRUCTIONS

The models shown in this user guide may not be available in all markets and are subject to change at any time. For current details about model and specification availability in your country, please go to our website www.fisherpaykel.com or contact your local Fisher & Paykel dealer.

Registration

Register your product with us so we can provide you with the best service possible.

To register your product visit our website: www.fisherpaykel.com

INTRODUCTION

Welcome to your new heat pump clothes dryer

Thank you for purchasing a Fisher & Paykel clothes dryer. We are proud of this dryer and trust it will serve you well for many years.

At Fisher & Paykel we aim to provide innovative products that are simple to use, ergonomic, energy efficient and kind to the environment. Thousands of tonnes of laundry and 80 years of experience have been programmed into your dryer to help give you the best possible performance.

Your dryer has the benefit of heat pump technology, which allows clothes to be dried at lower temperatures, improving clothes care while saving energy. This dryer also has the advantage of not needing to be vented outside, instead it condenses the moisture from the clothes and collects this in a water tank, or for convenience, can pump it directly into a drain.

Your new dryer gives you the convenience of tumble drying and your clothes the advantage of not being subjected to the harsh overdrying effects of the sun. Your clothes will feel softer, retain their shape and require less ironing. This dryer has been specifically designed to complement our front loading Fisher & Paykel washers.

Your heat pump dryer has numerous cycles and options so you can perform every drying task (including flat drying) with ease, allowing you to spend less time in the laundry. With the ability to automatically sense when your clothes are dry, your dryer is more efficient, making it kinder on your wallet and the environment.

Please take the time to read these instructions carefully before you begin using your dryer. Following the advice in this user guide will ensure you get the performance you expect from your dryer and that you get the best possible results. Keep these instructions for future reference and pass them on with your dryer, if it changes hands.

We hope you enjoy your new dryer. We have certainly enjoyed designing it for you.

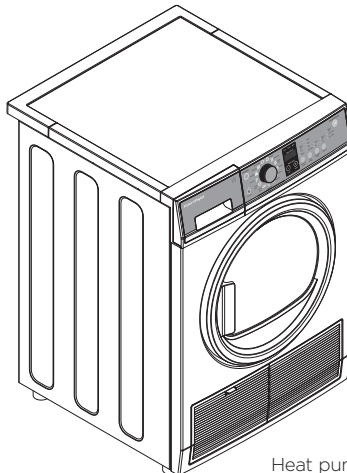

Heat pump clothes dryer

SAFETY AND WARNINGS

Meaning of symbols on the dryer



Warning: Risk of fire/Flammable materials



Read the instructions

WARNING!



Fire Hazard

- Only dry fabrics that have been washed with water.
- Do not use heat to dry articles containing foam rubber or similarly textured rubber-like materials, dry on 'Air Dry'.
- Do not stop a tumble clothes dryer before the end of the drying cycle unless all items are removed and spread out in order to dissipate the heat.
- A clothes dryer produces combustible lint; the lint filter must be cleaned before each drying cycle.
- Failure to follow the warnings outlined in these user instructions can cause a fire hazard.
- Failure to follow these instructions can result in death or personal injury.

IMPORTANT SAFETY INSTRUCTIONS

WARNING! When using this appliance always exercise basic safety precautions including the following:

Dryer use

- The tumble dryer is intended only for drying textile material washed in water.
- Undergarments that contain metal reinforcements should not be placed in the dryer. Damage to the dryer can result if the metal reinforcements come loose during drying. If you wish to dry these items use a drying rack or place in a garment bag.
- Check and remove all objects from pockets, eg lighters and matches.
- The maximum mass of dry textile material is eight kilograms. Do not overload your dryer.
- Never dry rubber articles, or any plastic items or film, eg plastic lined tablecloths and baby bibs.
- Clothes should go through the cool down/airing phase in the final part of the cycle. This ensures items are left at a temperature where they will not be damaged. If for any reason the dryer is stopped before the cycle has finished, dry clothes should be removed immediately and not left in the dryer. Clothes should be quickly spread out flat to cool so heat can dissipate, not left bunched up, eg in a clothes basket.
- This dryer has been designed for domestic use only, not for commercial applications, such as massage/beauty clinics where there may be increased lint accumulation or flammable materials in the atmosphere or load.
- Do not operate this product without the lint filters in place or allow lint to accumulate in or around the dryer.

SAFETY AND WARNINGS

- This dryer is not intended for use by persons (including children) with reduced physical, sensory or mental capabilities, or lack of experience and knowledge, unless given supervision or instruction concerning the use of the dryer by a person responsible for their safety.
- Children should be supervised to ensure they do not play with the dryer.
- Unplug the machine from the power supply when it is not in use.
- Do not swing or put weight on the door.
- Your dryer is designed to stop operating in the event of power outage. When power is resumed, the machine will remain off until the 'POWER' ⓐ button is pressed. To restart the dryer, press 'POWER' ⓐ, select your drying cycle and touch ▶||.
- Never attempt to repair the dryer yourself.
- The only user-removable parts of the dryer are the drain hose, lint filter, drying rack, condenser filter and the water tank. No other parts are designed to be removed by anyone other than a Fisher & Paykel Authorised Repairer.
- For problems that cannot be solved from information in this User Guide, turn off and unplug your dryer and contact a Fisher & Paykel Authorised Repairer.
- When disposing of the dryer, it is recommended that the door is removed to avoid children getting trapped inside, and that the electrical cable is cut off close to the dryer.

IMPORTANT!

We do not recommend the use of extension cords or portable electrical outlet devices for safety reasons. If you are using an extension cord or portable electrical outlet device (eg multi-socket outlet box) ensure that it is positioned so that it does not come into contact with water or moisture.

Lint

- Accumulated lint in the dryer can become a fire hazard; it also reduces the efficiency of the dryer by causing longer drying times and increased power consumption.
- Clean the lint filters before every load.
- Ensure the area around the dryer is clear of lint.
- At regular intervals have the interior of the dryer cleaned of any accumulated lint. This must be done by a Fisher & Paykel trained and supported service technician.

Spontaneous combustion

IMPORTANT!

To reduce the risk of fire in a tumble dryer the following should be observed:

- Items that have been spotted or soaked with vegetable oil or cooking oil are a fire hazard and should not be placed in a tumble dryer.
- Oil-affected items can ignite spontaneously, especially when exposed to heat sources such as a tumble dryer. The items become warm causing an oxidation reaction in the oil. This oxidation creates heat. If the heat cannot escape the items can become hot enough to catch fire. Piling, stacking or storing oil-affected items can prevent heat from escaping creating a fire hazard.
- If it is unavoidable that fabrics that contain vegetable oil, cooking oil or have been contaminated by hair care products be placed in a tumble dryer, they should first be washed in hot water with extra detergent - this will reduce, but not eliminate the fire hazard. The cool down cycle of the dryer should be used to reduce the temperature of these items. They should not be removed from the tumble dryer and piled or stacked while hot.

SAFETY AND WARNINGS

- Items that have previously been cleaned in, washed in, soaked in or spotted with flammable liquids or solids, eg petrol/gasoline, kerosene, dry cleaning solvents, vegetable or cooking oil, acetone, denatured alcohol, some brands of spot removers, turpentine, waxes and wax removers or other flammable or explosive substances should not be placed in a tumble dryer.
- Do not dry unwashed items in the tumble dryer.
- The dryer is not to be used if industrial chemicals have been used for cleaning.
- Fabric softeners or similar products should not be used in a tumble dryer to eliminate the effects of static electricity, unless this practice is specifically recommended by the manufacturer of the fabric softener product.
- Rubber backed articles, foam rubber (latex foam), clothes or pillows fitted with foam rubber pads, fibreglass, shoes containing rubber, shower caps, babies waterproof napkin covers and waterproof textiles should not be dried in the dryer. These materials can when heated produce fire by spontaneous combustion.

Disposal

Extreme care must be taken when disposing of your old appliance to avoid hazards.

INSTALLATION INSTRUCTIONS

Please read and follow the ‘Safety and warnings’ and ‘Installation instructions’ sections carefully before using your dryer!

Moving your appliance

If the dryer needs to be placed at an angle for moving, only tip towards the right hand side (when viewed from the front). If the dryer has not been transported as described, leave it standing upright for at least one hour before turning on.

Accessories

Please check you received the following accessories with your Fisher & Paykel dryer. You will find them inside the drum:

- 1 x Drying rack
- 1 x Drain hose
- 1 x Installation instructions and user guide

Unpacking

To ensure the best performance from your new dryer please follow the instructions below.

Removing the packaging

- ① Remove the outer packaging (including the polystyrene packer and plastic wrapping). All packaging must be removed prior to use.
- ② Tilt the machine backwards and ‘walk’ it off the base one foot at a time. Not doing so may cause damage to your floor and dryer.
- ③ Remove all packaging and accessories from inside the drum and ensure you remove protective covers from door and console.

IMPORTANT!

- Ensure packaging materials are kept out of reach of children.
- Please help protect the environment and dispose of the packaging from around the dryer in an environmentally friendly manner.

Location

IMPORTANT!

- The dryer must be installed in a well-ventilated, dust-free environment.
- The dryer must not be installed on any textured floor coverings (eg carpet, rugs) to ensure that openings at the base of the machine are not obstructed.
- Do not install the dryer behind a lockable door, sliding door, or behind a door where the hinge is on the opposite side to that of the dryer in such a way that the full opening of the door is inhibited. Ensure the dryer door can always be opened fully.

Note: this dryer CANNOT BE INVERTED AND MOUNTED ON THE WALL.

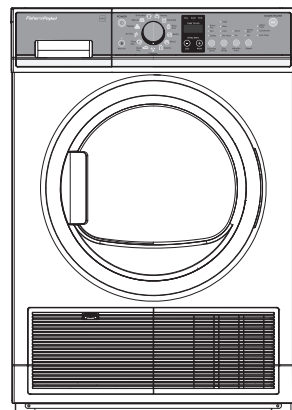

Free standing

INSTALLATION INSTRUCTIONS

Installation options

Your dryer can be installed one of two ways, either freestanding, or stacked on top of a Fisher & Paykel front loading washer.

① Free standing

The dryer stands on the floor and can easily be moved into position.

② Stacking

Your dryer has been designed to be able to be stacked on top of a Fisher & Paykel front loading washer. **A stacking kit MUST BE USED between the products and fitted correctly to the washing machine and dryer, as per the stacking kit instructions.**

- Stacking Kit White: Part No. 427976.

① Move the machine into the desired position. Do not lift the dryer by the top panel.

② Have a minimum clearance on all sides of at least 20 mm.

③ Install the machine on a stable and level floor (if not stacking on top of a front loading washer).

- Do not install your dryer in such a way that the dryer door cannot be opened fully.
- Do not install the dryer outside, in a damp place, where there is a risk of freezing, where it may be rained on, in direct sunlight or close to a source of heat.
- Do not place your machine on top of its power cable.

Levelling the machine

It is **IMPORTANT** to level the machine to ensure the machine runs efficiently with minimal noise. The dryer should be levelled in as close to its final position as possible so it stands balanced evenly on all four feet. Ensure the dryer does not rock in any direction.

The dryer comes with four adjustable feet, wind all four feet up or down until the dryer is correctly level. A spirit level can assist with this process. The machine is considered level when the bubble sits in the centre (ie within the two lines or the circle), when the spirit level is placed flat on top of your dryer, in the directions from:

- ① left to right,
- ② back to front and
- ③ corner to corner.

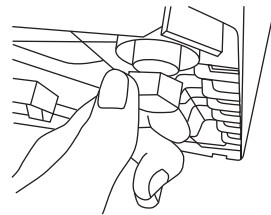

Levelling the feet

Never unscrew the feet completely from their housings.

Note: after levelling, the corners of the dryer cabinet should be clear of the floor and the machine must not rock in any direction.

INSTALLATION INSTRUCTIONS

Draining

The dryer is equipped with a condenser unit which accumulates water during the drying cycle. This water is collected in the removable water tank located at the top left of the dryer. The accumulated water must be emptied after each drying cycle. However you can also set up your dryer to drain automatically using the drain hose provided.

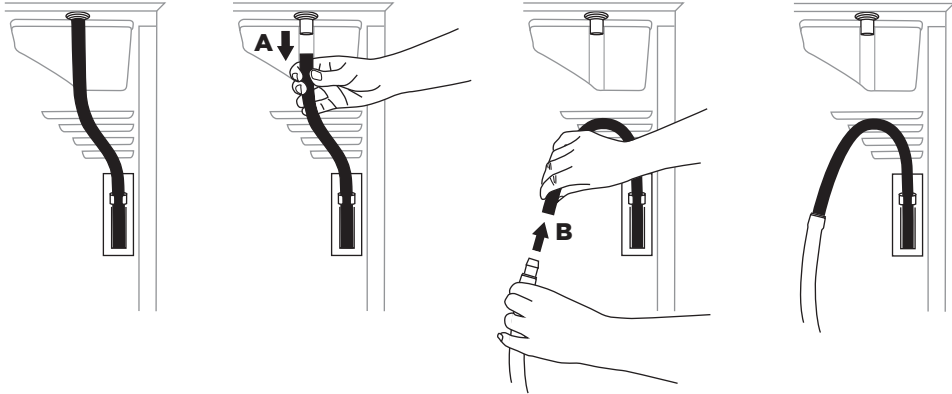

Connecting the drain hose:

- ① Remove the black hose from the connection at the back of the dryer (**A**).
- ② Uncoil the drain hose (included with your dryer) and connect it to the black hose (**B**).
- ③ Place the other end of the drain hose into a tub or standpipe.

IMPORTANT!

If you connect the drain hose onto your dryer and you do not secure the other end in a drain, your dryer will drain water onto the floor. Ensure the drain hose is securely fixed in place to an appropriate drain and is leak-free at the connection to the machine. Check the connection and drain hose regularly.

- Maximum standpipe height is 1.0 m from ground level.
- Regularly check that your standpipe or tub is free from lint and other obstructions, which may affect drainage and cause flooding.
- The drain hose should be checked from time to time and replaced if any damage, eg wear, cuts, bulges, kinks, leaks, etc are found. Do not bend the drain hose sharply, as this may cause it to split.
- The extended length of the provided drain hose is 1.3 m.
- In multi-storey apartments or any upper floor, the machine should be installed on a floor equipped with a drain.
- Draining must comply with local by-laws.

INSTALLATION INSTRUCTIONS

Electrical connection

- ① This appliance must be connected to a 220 V - 240 V, 50 Hz, sinusoidal, 10 A electrical supply.
 - ② Uncoil the power cord, remove and discard the plastic pin cover and plug into a power socket.
 - ③ Connect the appliance to an earthed outlet protected by a fuse of suitable capacity.
- Check the power cord for damage and make sure it is not squashed or twisted when installing the dryer.
 - Always remove the power cord from the power socket by the plug, not by the cord.

IMPORTANT!

- **Do not touch or operate the machine with wet hands or with bare-feet.**
- **A damaged power cord must be replaced by a Fisher & Paykel Authorised Repairer, its service agent or similarly qualified persons in order to avoid a hazard. The appliance must not be operated until it is repaired, as there is risk of electric shock.**
- **Do not operate this machine if it has been damaged during transport. Contact your Fisher & Paykel dealer or Fisher & Paykel Authorised Repairer.**

INSTALLATION INSTRUCTIONS

Completing the installation

Installation test cycle

IMPORTANT!

Ensure the installation test cycle is completed before you dry any items in your dryer. This is to check that your dryer is installed correctly and that it is functioning properly prior to use.

- ① Turn your dryer on by pressing the 'POWER' ① button.
- ② Select the 'Time Dry' cycle for 30 minutes. Ensure the drum is empty and the door is closed (you will hear it click shut).
- ③ Touch the ►|| button. The drum will start rotating.
 - Observe the machine for any problems.
 - The dryer will beep and display any faults on the screen if there are any problems. Refer to pages 26 and 27.
- ④ At the completion of the cycle, open the door and check that there is warmth inside the dryer. This indicates the dryer is operating normally.

IMPORTANT!

If there are any problems, you must address these before proceeding with normal use. The dryer will automatically turn off at the end of the cycle if there are no problems.

Before you start, it is a good idea to go through the following checklist:

- ① Has the packaging been removed?
- ② Is the machine correctly levelled, and the cabinet corners clear of the floor and walls?
- ③ Are the water tank, condenser filter and lint filter correctly in place?
- ④ Has the power cord been connected to an appropriate power supply and the power turned on?
- ⑤ Have you performed the installation test cycle?
- ⑥ If external draining is preferred, is the drain hose attached to the correct outlet and hooked into a standpipe or tub?

INSTALLATION INSTRUCTIONS

Machine specifications



	DH8060P
Capacity (kg)*	8
DIMENSIONS (mm)	
Width	595
Depth	650
Height**	845
Length of drain hose	1300
ELECTRICAL	
Volts	220 - 240
HZ	50
Amps (maximum)	10
Heating Power (W)	900

* Capacity refers to the maximum **dry** weight of items the machine can dry at any one time.
Note: some cycles have a lower maximum capacity (see the 'Drying cycles' section).

** The exact height of your dryer is dependent on how far the feet are extended from the base of the machine.

GETTING STARTED QUICKLY

- Check the lint filter is clean and the water tank is empty before every load. Ensure both are replaced correctly before using your dryer. The lint filter indicator will be on when the machine is on as a reminder to check the lint filters.
- Sort and load items into the dryer drum, ensuring no items are in the way of the door. Close the door (you will hear it click shut).

- ① Press 'POWER'  to activate your dryer.
- ② Your dryer will default to the 'Everyday' cycle. Select your desired drying cycle by turning the SmartTouch™ Control Dial.
- ③ Select your preferred drying options, using the SmartTouch™ buttons on the right hand side of the panel (if you wish to select options different from the default options for the cycle).
- ④ Touch the  button to start the cycle.

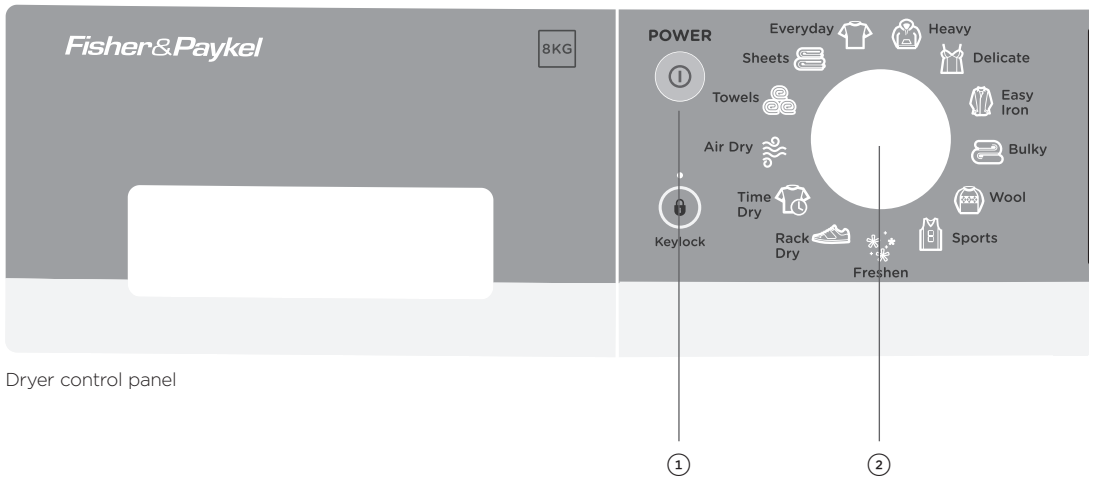

Dryer control panel

GETTING STARTED QUICKLY

- If you make an invalid selection the dryer will beep to alert you.
- When the cycle finishes, your dryer will beep and then turn off automatically. If the 'Wrinkle Free' option has been selected the machine will rotate the drum periodically blowing cool air into the drum to help minimise wrinkling and creasing of your load.
- If you wish to change a cycle or select a different option once a drying cycle has started, touch the ►|| button then select the new cycle or option. Touch ►|| to restart the dryer with the new cycle and/or settings.

IMPORTANT!

- **If you wish to stop the dryer before the cycle has finished you MUST remove the clothes IMMEDIATELY and spread them out to cool. DO NOT leave the clothes in the dryer or bunched up in a clothes basket. Take extreme care as the drum and the load items may be hot.**
- **Failure to follow the advice in this guide may result in damage to your garments and your expectations of drying performance may not be met.**

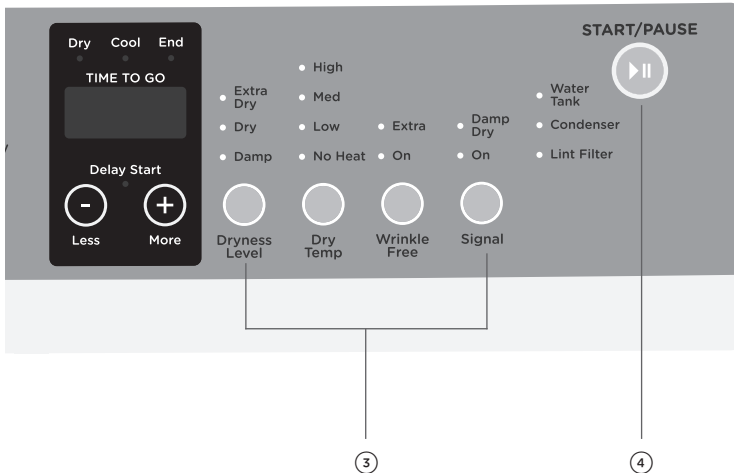

DRYER CONTROLS

SmartTouch™ Control Dial

The SmartTouch™ Control Dial provides easy and efficient drying cycle selection. As you rotate the dial, the icon of the drying cycle selected will be illuminated, along with the default settings for that cycle on the right side of the control panel.



SmartTouch™ Control Dial

SmartTouch™ buttons

The smooth, easy clean buttons enable simple selection of options with lights clearly showing the selections you are making.



SmartTouch™ buttons

Digital display screen

The digital display screen provides feedback on how long the drying cycle has to go. If you have programmed a 'Delay Start', the time remaining until the cycle will start will be displayed here, along with any messages to help you with the overall running of your dryer (eg user warnings).

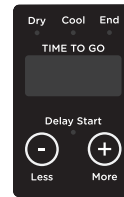

Digital display screen

Time to go

Your dryer displays approximately how many minutes the cycle you are running has remaining if you have chosen one of the Time Dry cycles. If you have chosen an automatic cycle (ie not 'Time Dry') the word *AUTO* will appear on the screen until it reaches the cool down phase, at which time the dryer will display how long the cycle has left to go.

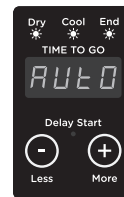

Time to go

Please be aware that a number of factors can influence the overall cycle time, eg the fabric type of garments, load size, the wetness of the load, environmental conditions etc.

Progress lights

The progress lights indicate what part of the cycle the dryer is currently on ('Dry', 'Cool' or 'End'). All three lights are on at the beginning of the cycle. The light for the current part of the cycle flashes, and each one goes out when that part of the cycle is complete.



Progress lights

Keylock

Keylock can be used to lock the buttons on your dryer. This will avoid accidental button touches. For more detail please refer to the 'Drying cycle options' section.



Keylock mode

SORTING AND LOADING

When preparing your load there are some important things to consider:

Sorting

- It is recommended that you sort your garments before placing them into the dryer. Sort into loads of similar items, and loads that will likely take similar times to dry. Heavier items (eg towels, and flannelette sheets) are best dried separately from lightweight items (eg synthetics, polyester-cotton sheets and shirts). This prevents the possibility of some items becoming over-dried whilst others are still damp. It will also help to extend the life of your clothing and linen.
- Look for a care label on your clothes as this will tell you if they can be safely tumble dried.
- Drying your clothes as soon as you remove them from the washer will decrease the chance of wrinkles forming, and dye transfer from coloured items to white items from occurring.
- We recommend that articles of clothing with screen-printing are turned inside out to prevent damage to the print. Garments with hooks or zippers should be fastened and where possible, turned inside out.
- Care labels on garments provide valuable information about the fabric type and how the garment should be dried. Always follow the advice on garment labels. Only dry items in this dryer that have a care label stating tumble drying is suitable.
- Separate coloured items from white/light items where possible, especially when new. Colour run may be an issue, especially if you intend to delay the start of the drying cycle.

SPECIFIC ITEM/DRYING REQUIREMENTS	SUGGESTED CYCLE AND OPTIONS	SUGGESTED TEMPERATURE	COMMENTS
Towels	Towels	High	Towels produce a lot of lint and are best dried on their own.
Sheets, pillowcases, duvet/duona covers	Sheets	High	Ensure duvet/duona cover openings are buttoned/domed before placing in the dryer.
Bulky items – doonas, duvets, sleeping bags, jackets	Bulky	Medium	Dry only one bulky item at a time and place a knotted towel into the machine at the same time to ensure the bulky item moves around evenly.
Business shirts, trousers, other creasables	Easy Iron	Medium	Wrinkle Free is automatically selected to help minimise creasing once the drying cycle has finished.
Woollens, silks	Wool	Low	Designed for items that could be damaged if they are tumbled, eg woollens. Use the drying rack.
Delicates, fine fabrics	Delicate or Rack Dry	Low	You can further reduce the dryness level to damp or use Rack Dry for very delicate items.
Jeans	Heavy	High	Turn jeans inside out to help maintain their appearance. Dry separately from other items.
Shoes, hats, soft toys or other odd shaped items	Rack Dry	Low	Check on the item regularly throughout the drying cycle. Ensure the rack has been correctly fitted. Only dry shoes on 'Low' drying temp.

SORTING AND LOADING

Before you load

- Check pockets for items that could damage your clothes or get caught in the dryer.
- Close zippers, hooks and eyes, and other fastenings (ie fasten the openings of duvet/doona covers), and remove loose bra wires. These may damage both your dryer and your clothes.
- Check the lint filter is clean and the water tank is empty (if the dryer is not set up to drain automatically).

Loading

- Garments need to be loaded correctly to minimise creasing and wrinkling, and to ensure the load is dried evenly. Make sure there is plenty of room for the garments to tumble freely while drying. Load items individually and loosely. (Hint: load the dryer in terms of the space the garments take up when dry, rather than when they are wet. The general rule is that one wash load equals one dryer load. Do not overload your dryer, as this may damage your dryer and clothes).
- It is a good idea to dry 'permanent press' type garments (eg business shirts) together on the 'Easy Iron' cycle with the 'Wrinkle Free' option on. This will help reduce wrinkling and the need for ironing.

To reduce tangling

- Load items individually.
- Dry sheets and duvet/doona covers on the 'Sheets' cycle. Ensure duvet/doona cover openings are fastened before placing in the dryer.
- Only dry a sheet load up to a maximum of 4 kg in the dryer at one time.

To reduce creasing

- Shake clothes out and load individually to help items dry evenly.
- Launder permanent press garments separately, eg business shirts.
- Allow enough room in the dryer for clothes to tumble freely.
- Hang garments as soon as the drying cycle is complete to reduce the need for ironing.

IMPORTANT!

- **Never put dripping wet clothes in or on top of the dryer as excess water may cause an electrical hazard.**
- **Do not place an item in your dryer unless the care label specifically states it is safe to do so.**
- **Do not dry curtains in your dryer. Sunlight makes them brittle and they may disintegrate during drying.**

SORTING AND LOADING

Drying times

- Drying very small loads is inefficient. Try to dry medium to large loads.
- Heavier items (towels, flannelette sheets) will take longer to dry than light items (synthetics and polyester cotton sheets and shirts).
- Drying times can be reduced by spinning the wash load at the highest spin speed suitable for the load type in your washing machine.

Drying bulky items

- It is important that you check the care label of any item carefully, to ensure it is suitable for tumble drying before placing it into the dryer.
- Check bulky items during the cycle to ensure even drying, pause the dryer and reposition the item if necessary.
- Do not overload the dryer, ensure there is enough space for the item to tumble.

Lint

Some items are lint givers, while others are lint collectors. Always dry lint givers and collectors separately.

LINT GIVERS	LINT COLLECTORS
Towels	Synthetics eg polar fleece
Flannelette sheets	Corduroy
	Polyester cottons

Delicate or easily damaged items (eg woollen or silk garments, nylon stockings, fine fabrics, delicate embroidered fabrics) should be dried separately, using the 'Delicate' cycle, or if you do not want them tumbled use the 'Wool' or 'Rack Dry' cycle. Sleeping bags and other down items should be dried on the 'Bulky' cycle.

Drying rack

There are many items that would benefit from being dried on a drying rack. For example items such as sport shoes, soft toys, hats and woollen items that may be damaged if they are tumbled.

A drying rack is installed in your dryer when it leaves the factory. To remove it, tilt the top of the rack towards you to detach the legs from the slots in the lint filter, and gently remove from the drum.

When you are using the drying rack you must select the 'Rack Dry' or 'Wool' cycle.

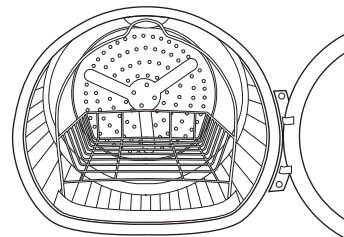

Drying rack



Drying rack cycle

DRYING CYCLES

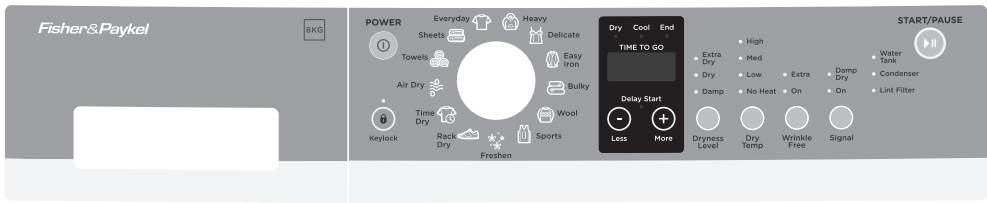

Your dryer has a number of drying cycles to suit your laundry needs. Selecting the most appropriate cycle for each particular load will help ensure you get the best result.

CYCLE	DESIGNED FOR	DESCRIPTION	MAX. LOAD SIZE (KG)	DEFAULT DRYNESS LEVEL*	DEFAULT DRYING TEMP
Everyday**	Everyday clothing eg t-shirts, trousers.	High heat cycle for rapid drying of everyday clothing.	8	Dry	High
Heavy	Heavy durable garments, eg work sweatshirts/ jerseys, rugby shorts, jeans, tea towels.	A longer, high heat cycle for heavy fabrics and denim.	8	Dry/ Extra Dry	High
Delicate	Delicate clothing items, eg synthetics, silk and fine fabrics.	A shorter, cooler cycle for carefully drying delicate and heat sensitive fabrics.	4	Dry	Low
Easy Iron	Business shirts and clothing that creases easily.	A short, medium heat cycle with the Wrinkle Free option is automatically selected for easily creasable items.	4	Damp/Dry	Medium
Sheets	Sheets, pillowcases and duvet/duona covers.	High heat cycle with reversing, to improve the movement of large items such as sheets and duvet/duona covers and help reduce tangling.	4	Dry	High
Towels	Towels.	High heat cycle for drying thick, absorbent items such as towels.	6	Dry	High
Bulky	Bigger items like jackets and duvet/duona covers.	A medium heat cycle for the special care of bulky items.	4	Dry	Medium
Sports	Sports clothing, eg running gear.	A low heat cycle designed to care for synthetic sports clothing.	4	Dry	Low
Wool	Woollen items, eg jerseys.	A low heat cycle for use with the drying rack to dry machine washable woollen items without tumbling. User selectable drying times of 30 - 150 minutes.	3	n/a	Low
Rack Dry	Items that cannot be tumbled, eg shoes, hats, delicate garments.	Specifically for use with the drying rack so items can be dried without tumbling.	3	n/a	Low
Freshen	Items that have been in storage or have not been worn/used for some time.	A short cycle with a burst of heat followed by cool air to help de-wrinkle and refresh items.	2	n/a	High
Time Dry	Drying items for a selected time period.	A cycle with user select 10 - 150 minute drying times.	8	n/a	High
Air Dry	Drying items for a specific time period, without heat.	40 minute cycle with no heat.	4	n/a	No Heat

* Dryness level is only an option on automatic sensing cycles. On 'Time Dry' and the 'Rack Dry' cycle, dryness will vary depending on the load and its initial moisture content.

** 'Everyday' cycle, 'Dry' dryness level and 'High' drying temp is the recommended cycle for everyday cotton items.

DRYING CYCLE OPTIONS

Timed programmes (Time Dry, Rack Dry, Wool)

Timed programmes of 10 to 150 minutes can be selected using the 'More' + and 'Less' - buttons.

The machine dries for the selected time regardless of the level of moisture in the load. It is important to check the clothes throughout the timed programmes to avoid over drying.

Default options

All drying cycles default to the recommended options for that cycle based on the average expected load to be dried using that cycle. You can vary the options (eg 'Dryness Level', 'Dry Temp') to create your desired cycle. Note: some options are not available on some cycles for clothes care reasons, or because the option is not appropriate for the cycle.

To change a drying option or options you have selected after a cycle has started, touch ►|| and select your new setting, then touch ►|| again to resume the cycle with the new setting or settings.

Note: some options may not be available for selection under certain conditions and after particular stages of the drying cycle have passed.

Dryness Level

Your dryer takes the guess work out of choosing drying times by sensing the dryness of the load. When your dryer senses that the clothes have dried to the dryness level selected, the dryer will automatically finish the cycle.

The dryer has five dryness levels ranging from 'Damp' through to 'Extra Dry'. Choose the dryness level to suit your load depending on how dry you wish for your clothes to be. If you find the load is not dry enough, select the next dryness level up. The higher the level, the longer the drying time and the drier your clothes will become.

Note: two lights are used to show some dryness levels. For example, to achieve the 'Damp Dry' setting both the 'Dry' and the 'Damp' lights will be illuminated.

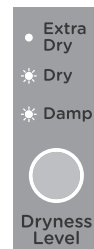

Dryness levels

Airing/Cool down (Cool)

When the dryer has sensed that the load is dry it will automatically go into an airing or cool down cycle. During 'Cool' the drum tumbles and cool air is blown through the clothes. This cools the load to reduce creasing if the clothes are left in the dryer.



Cool down mode

DRYING CYCLE OPTIONS

Dry Temp

There are four drying temperatures you can choose from:

- 'High' - clothes temperatures may reach up to 70°C.
- 'Medium' - clothes temperatures may reach up to 65°C.
- 'Low' - clothes temperatures may reach up to 60°C.
- 'No Heat' - cool air is blown through the dryer for the period selected.

Touch the 'Dry Temp' button until the light next to your desired drying temperature is illuminated.

Wrinkle Free

If you wish to minimise wrinkling, select one of the 'Wrinkle Free' options. At the end of the cycle, the drum will rotate periodically and cool air will be circulated through the load to minimise wrinkling and creasing. This is particularly useful if you cannot remove the items immediately after the cycle ends.

There are two wrinkle free options:

- 'On' provides 'Wrinkle Free' operation for 1 hour.
- 'Extra' provides 'Wrinkle Free' operation for 24 hours.

If you wish to stop the dryer at any point during the 'Wrinkle Free' stage of the cycle, simply touch ►||. You can then open the dryer door and remove your items. Press 'POWER' ⓘ to turn the dryer off.

Signal

The 'Signal' option automatically defaults to 'On' for all cycles. This means a series of beeps will sound at the end of a cycle to alert you that the dryer has finished. You can turn the 'Signal' off by touching the 'Signal' button twice (no lights will then be illuminated).

When you select a dryness level above 'Damp/Dry' and wish your dryer to alert you to remove items once your load reaches the damp/dry stage, touch the 'Signal' button once to select 'Damp Dry'. Ensure 'On' is also selected. When your load reaches the damp/dry stage, the dryer will beep to alert you to remove your items, then it will continue drying until the remaining load reaches the dryness level you selected.



Dry temp



Wrinkle free option



Signal options

DRYING CYCLE OPTIONS

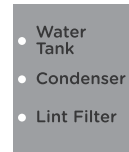

Indicators

There are a number of indicators to alert you when you need to attend to your dryer, either to clean the lint filter, empty the water tank or to clean the condenser filter (refer to the 'Caring for your dryer' section for more information).



Indicators

Keylock



This option enables you to deactivate the buttons on the display panel, except for the 'POWER'  and  buttons. This option helps prevent accidental button touches.

To turn Keylock mode ON or OFF, at any time when the dryer is powered on:

- Touch and hold the  button for 2 seconds.





Note: when activated, the light above the  button is illuminated.





If Keylock mode is activated and the machine is powered off:

- To turn your dryer on, press the 'POWER'  button, then touch and hold the  button for two seconds to turn Keylock mode off. Select your drying cycle, any options and then touch  to start the cycle.

Delay Start

The 'Delay Start' option enables you to delay the start of the drying cycle from between 5 minutes and 12 hours. Times you can select are 5 min, 15 min, 30 min, 1 hour, then hourly up to 12 hours. This can be useful to time your drying to finish when you arrive home from work, or to start when power rates are lower.

To programme a 'Delay Start', simply touch the 'More'  button to increase the delay time and 'Less'  button to decrease the time or to turn 'Delay Start' off. Touch  to confirm your selection and start the countdown. Once the 'Delay Start' has been started, the time will count down on the digital display in one minute increments, the 'Delay Start' light will flash and the  light will stop flashing and remain lit.

Note: if you hold the 'More'  button down, the time displayed on the screen will increase after every half a second (more convenient than touching the button repetitively). To remove a delay start time once it is counting down, simply touch , then touch the 'Less'  button to decrease the time to zero. Touch  to start the cycle immediately.

IMPORTANT!

We suggest that you avoid using 'Delay Start' for damp, non-colourfast items as this may cause dye run to occur.

DRYING CYCLE OPTIONS

Customising dryer cycles

After using your dryer a few times you may discover there are some drying options you prefer for some cycles.

You can programme your dryer to remember the drying options you prefer for each drying cycle. For instance, you may want to set the 'Easy Iron' cycle to a lower drying temperature or programme the 'Everyday' cycle so it automatically has the 'Wrinkle Free' option selected.

To customise a cycle:

- ① Press 'POWER' **ⓘ** to turn the machine on.
- ② Turn the dial to select the cycle you wish to customise.
- ③ Touch and hold any of the drying options buttons for 3 seconds. The lights will flash on and off and the display will show 'SEt' to indicate that the machine is in cycle adjustment mode.
- ④ Select the drying options you prefer by touching the relevant option button.
- ⑤ Touch **Ⓛ** to save the selected settings. The dryer will beep to indicate your customised cycle has been saved.

Note: touching **▶||** before pressing 'Keylock' will exit the cycle adjustment mode and start the cycle using the settings shown on the display panel.

Factory reset

You can reset your dryer to the default settings it left the factory with:

- ① Turn the dial to select the 'Freshen' cycle.
- ② Touch and hold the 'Delay Start', 'More' **+**, the 'Delay Start', 'Less' **-** and 'Signal' buttons together for three seconds.
- ③ Your dryer will now be reset to the default settings it left the factory with.

CARING FOR YOUR DRYER

When you have finished using your dryer

- Unplug the machine from the power socket.
- Wipe around the door to remove any remaining condensation and foreign matter.
- Clear the lint filter and empty the water tank (if not set up to automatically drain).

Cleaning your dryer

Before you start cleaning your dryer, ensure that it is disconnected from the power (ie unplug the machine from the power socket).

Cleaning the control panel and outer surfaces of the dryer

Use a soft damp cloth to wipe all surfaces, then wipe dry. Avoid using chemical or scouring cleaners, as these will damage the paint and plastic surfaces of your dryer.

Cleaning the inside of your dryer

It is important that you occasionally clean the inside of your dryer. If the drum has any residual dirt or lint stuck to it, remove this and wipe it clean with a damp cloth. Do not leave any metal objects in the drum, as these may cause rust.

Cleaning the lint filter

- Lint is generally formed during wearing and washing. Fibres (ie lint) released from the clothes during the drying cycle are collected in the lint filter.
- It is important to clean the lint filter after every load, as the lint produced in the drying process can become a fire hazard if it is allowed to accumulate in or around your dryer.
- The lint filter is located in the door opening (at the bottom).
- There is a warning light that will flash at the beginning of every cycle to remind you to clean the filter and will stop once the ▶|| button is touched. The warning light will also flash on and off during the cycle if the filter becomes blocked. The filter should be cleaned as soon as the 'Lint Filter' light starts flashing. Lint becomes a fire hazard if left to build up, and will reduce the efficiency of your dryer.

To clean the filter:

- ① Open the dryer door.
- ② Remove the lint filter by pulling it up and out of the filter slot. Open it out and wipe the surfaces clean with your hand.
- ③ Close the lint filter and place it back in the opening. Ensure the filter is fitted correctly back in place before operating the dryer.

IMPORTANT!

If the lint filter becomes damaged, contact your Fisher & Paykel Authorised Repairer to arrange getting a new filter. Do not operate your dryer with a damaged lint filter or without the filter in place, as this will cause damage to your dryer and is a fire hazard.

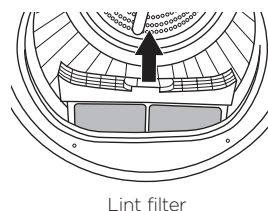

Lint filter

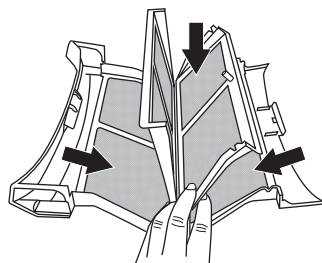

CARING FOR YOUR DRYER

Emptying the water collection tank

During the drying cycle steam condenses into water and is collected in the water tank, located at the top left of the dryer. It is important to empty the water tank after every load.

There is an indicator light that will illuminate when the water tank needs emptying. A user warning will also be displayed on the screen (refer to the 'Before you call for service' section). If the water tank becomes full during operation, the dryer will go into 'Cool' mode for several minutes, then pause and beep to alert you. Empty the tank and touch ►|| to resume the cycle.

Note: you do not need to empty the water tank if you have set up the drain hose to drain the water automatically.

To empty the water tank:

- ① Remove the water tank by holding onto the handle and pulling outwards gently to remove it. Ensure that you keep the tank level when it is being removed to prevent the water collected from spilling.
- ② Pour the water down the sink or into a bucket, and then put the tank back in place.

IMPORTANT!

- **Do not use the water collected in the water tank for drinking or food processing.**
- **Never run the dryer without the water tank in place unless the drain hose has been installed.**
- **If the water tank becomes full, the tumble dryer will pause drying and will sound an alarm. You must empty the water tank before the dryer can continue drying. Empty the tank, replace it in the housing then touch ►|| to resume the cycle.**

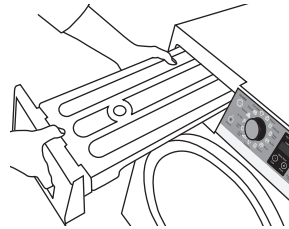

Removing the water collection tank

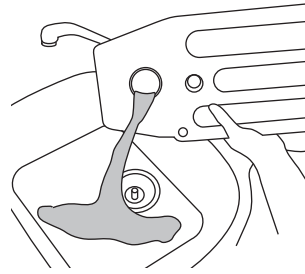

Tipping out the water from the condensing tank

CARING FOR YOUR DRYER

Cleaning the condenser filter

If the 'Condenser' indicator light starts to flash this indicates that the condenser filter needs to be cleaned. The condenser filter should be cleaned after every five cycles. The light illuminates when you first turn the machine on, then turns off once the ►|| button has been touched.

To clean the condenser filter:

- ① Switch off the power supply and remove the power plug before cleaning the condenser.
- ② Open the condenser filter cover.
- ③ Turn the four condenser lock levers 90° then pull out the condenser filter.
- ④ Remove rear filter and wipe the surface clean with your hand.
- ⑤ Replace the condenser filter.
- ⑥ Turn the four condenser filter lock levers to lock the condenser filter back in place again. Make sure that these locks are engaged securely.
- ⑦ Close the condenser filter cover.

Note: if the evaporator behind the condenser filter is dirty, it can be cleaned carefully with a vacuum cleaner using a dusting brush or narrow crevice nozzle.

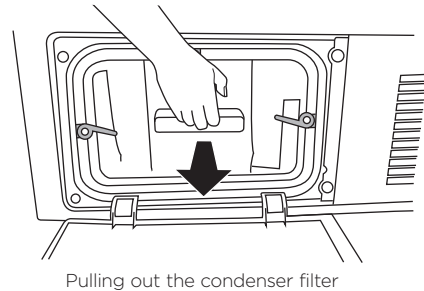
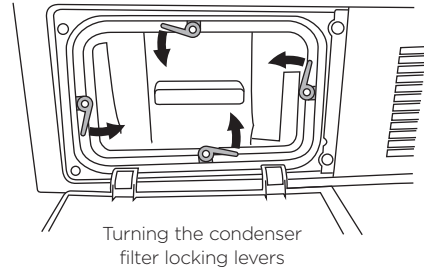

Cleaning the sensors

There are sensors in your dryer that detect whether the laundry is dry or not. These sensors need to be cleaned periodically (we recommend approximately four times a year).

To clean the sensors:

- ① Open the door of your machine.
- ② Allow the machine to cool if drying has been carried out.
- ③ Locate the metal sensors just behind the lint filter.
- ④ Wipe the sensors with a soft cloth, dampened with vinegar. Dry the sensors with a soft dry cloth.

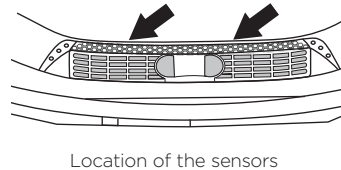

BEFORE YOU CALL FOR SERVICE

User warnings

Your dryer is capable of diagnosing a number of its own problems. It will sound a continuous series of beeps and display a code when it has a problem that you can correct yourself. All control panel lights will turn off and a code will be displayed to inform you what the problem is. To stop the beeps sounding, press any button on the control panel. Do not try to continue your drying cycle once you stop the noise. You must address the problem the dryer is alerting you to.

Check this chart before you call for service.

PROBLEM	DISPLAYED AS	WHAT TO DO
The lint filter is blocked and needs to be emptied	<i>cLn</i> <i>Lint</i>	Empty the lint filter and then replace it.
		Check the lint filter is not damaged.
		Check there is nothing else stuck in the lint filter holder which may be blocking the air flow.
		Check the lint filter is in place correctly in your dryer.
The water tank is full and needs to be emptied	<i>H2O</i> <i>FULL</i>	Check if the water tank is full.
		Empty the water tank.
		If using the drain hose, check whether the water tank or drain hose is blocked.
The door is not closed	<i>door</i>	Check the drain hose is still attached at the back of the machine, and is not kinked or squashed.
		Close the door fully and touch ► .
		Try opening and closing the door again.
The drying rack is not in place.	<i>Fit</i> <i>rack</i>	Reposition the load, make sure the load is correctly in the drum and that protruding items are not preventing the door from closing.
		Fit the drying rack.

Once you have addressed the issue the user warning was alerting you to, try using your dryer as per usual.

If the symptom persists, please call your Fisher & Paykel Authorised Repairer.

FAULT CODES

When a continuous series of beeps is sounded, all the lights turn off on the control panel and a number appears on the display, a fault has occurred. The dryer will automatically enter this mode if a fault occurs. The fault code will be displayed as *E* followed by a number on the digital display. To stop the beeps, touch any button then perform the following steps:

- ① Turn your machine off at the power point.
- ② Wait one minute and turn it back on.
- ③ Check your machine is installed correctly (refer to the 'Installation instructions' section).
- ④ Remove your load from the dryer and retry.
- ⑤ Perform a 'Time Dry' cycle, eg Time Dry for 10 minutes.
- ⑥ If the fault re-occurs repeat steps ① and ②.
- ⑦ If the machine still will not work, you will be required to call a Fisher & Paykel Authorised Repairer to arrange service (refer to the 'Customer Care' section). Record the fault code number displayed and the serial number of your dryer (located on the rear of the machine, or on the inside of the door below the glass) before calling. The fault code will indicate to the Repairer what the problem could potentially be.

If a fault code is being displayed, you can still turn your dryer off by pressing 'POWER' ①.

TROUBLESHOOTING

The following is a list of problems you may encounter when using this appliance and some suggestions that may help to correct the problem. If you still have problems, please contact your Fisher & Paykel Authorised Repairer.

PROBLEM	POSSIBLE CAUSES	WHAT TO DO
Pressing 'POWER' ⓘ does not turn on the dryer.	Fault with household power supply.	Try plugging in and turning on another electrical appliance.
Dryer does not heat.	Dryer set to 'Air Dry' cycle.	Check what cycle the dryer is set to (refer to page 18). Change to preferred cycle.
	Full water tank.	Empty the water tank (refer to page 24).
	The dryer has progressed to 'Cool'.	Check the progress lights - are the 'Cool' and 'End' lights illuminated? Refer to page 19.
Touching ▶ does not start the drying cycle.	Dryer door not closed properly.	Open and reclose the door. Check that the lint filter is correctly in place and not obstructing the door.
	Is the dryer displaying a user warning or fault code?	Refer to pages 26 and 27.
	Water tank full or not properly in place.	Empty the water tank (refer to page 24). Ensure the water tank is properly in place.
	Lint filter needs to be emptied.	Empty the lint filter and ensure it is correctly in place.
	Dryer is overloaded.	Remove some items from the dryer.
	'Delay Start' function is set.	Refer to page 21 for more information.
Dryer keeps stopping and starting.	The 'Wrinkle Free' option has been selected.	Refer to page 20 for more information.
Dryer stops working mid-cycle.	Power failure.	Press 'POWER' ⓘ and restart the desired cycle.
	Dryer has been paused.	Touch the ▶ button to restart the cycle.
	Dryer door is open.	Ensure the door is firmly shut.

TROUBLESHOOTING

PROBLEM	POSSIBLE CAUSES	WHAT TO DO
Dryer is taking too long/results were not satisfactory.	Drying cycle selected not appropriate for the load.	Select an appropriate cycle for the load. Refer to pages 15 and 18.
	Dryness level selected not appropriate for the load.	Select a higher dryness level. Refer to page 19.
	Selected drying temp, not appropriate for the load.	Select a higher drying temp. Refer to page 20.
	Dryer overloaded for the cycle.	Some cycles have a lower max load size. Refer to page 18. Try dividing the load in half and dry half at a time.
	Lint filter is blocked.	Clean the lint filter.
	Condenser filter is blocked.	Clean the condenser filter. Refer to page 25.
	Water tank is full.	Empty the water tank. Refer to page 24.
	Environmental conditions may be affecting dryer operation.	In hot, humid conditions the dryer will take longer to dry a load and be less efficient.
	Load overly wet at the start of cycle.	Remove more water from the load before placing it in the dryer, eg select a faster spin speed on your washer, if appropriate for your load.
	Dryer not draining water out properly.	Check the drain hose (if connected) for blockages or damage. You may need to call for service refer to page 36.
Items got tangled.	Try separating items and drying similar items together. Open items out when you place them in the dryer. Do not fold them. Untangle items, eg pull long sleeves out so they are not stuck/trapped on the inside of the garment.	
Dryer is not draining.	Drain hose not connected to the water tank.	Ensure the drain hose is connected correctly. Refer to page 8.
	Water tank not in place correctly.	Ensure water tank is properly in place.
	Drain hose or drain blocked or damaged.	Check drain hose (if connected) and drain for blockages or damage.

TROUBLESHOOTING

PROBLEM	POSSIBLE CAUSES	WHAT TO DO
Clothes getting too hot or damaged.	Cycle selected not appropriate for the load.	Ensure the cycle selected is appropriate for items in the load. Refer to pages 15 and 18.
	Items removed from dryer before the end of cycle cool down had finished.	Removing items before cool down may damage clothing if it is not spread out and exposed to air to cool once removed from the dryer.
Dryer is beeping, displaying unfamiliar light patterns and/or a message on the digital display.	Dryer has a fault.	Try turning the dryer off and waiting 30 seconds before turning it back on. Refer to pages 26 and 27.
Small puddle of water coming from under the machine.	Water tank not correctly in place.	Ensure the water tank is correctly in place.
	Water tank may need to be emptied.	Empty the water tank.
	Water tank may be damaged.	Check the water tank for any signs of damage.
	Drain hose may not be attached properly at the machine end.	Ensure the drain hose is attached properly. Refer to page 8.
	Drain hose could be damaged.	Check the drain hose for damage.
	Drain hose has slipped out of the drain.	Ensure the drain hose is securely fixed in place. Sometimes drain hoses can move or get displaced, which may lead to water draining onto the floor.
	Drain may be blocked.	Check the drain for any blockages.
Small amount of water in the drum at end of cycle.	Dryer door not closing properly, affecting the seal.	Ensure the dryer door is closed properly and there is nothing obstructing the door opening.
	Water tank needs to be emptied.	Empty the water tank.
	Environmental conditions may be affecting dryer operation.	If conditions are particularly hot and humid, it is possible vaporised water may re-condense in the drum or on the inside of the door.

TROUBLESHOOTING

PROBLEM	POSSIBLE CAUSES	WHAT TO DO
Noises.	Dryer is overloaded.	Remove some items from the dryer.
	Dryer has a fault.	Continuous beeping or a musical series of beeps with a message displayed on digital display. Refer to pages 26 and 27.
	Beeps signalling the end of a drying cycle.	End of cycle beeps can be turned off refer to page 20.
	Dryer has not been levelled properly.	Refer to page 7.
	Dryer makes unfamiliar noises.	At the start of the cycle the dryer may make some unfamiliar noises when the compressor turns on.
Vibration.	Dryer is not installed on a stable surface.	Ensure the dryer is installed on a flat, stable surface. Refer page 6.
	Dryer is not level.	Ensure the dryer is correctly levelled. Refer page 7.
	Dryer is overloaded.	Remove some items from the dryer.
Creasing.	Cycle selection not appropriate for the load.	Select the 'Easy Iron' cycle to minimise creasing.
	Dryer is overloaded.	Remove some items from the dryer.
	'Dry Temp' and/or 'Dryness Level' selected too hot/too long for load type.	Try selecting a lower 'Dry Temp' and 'Dryness Level'.
	'Wrinkle Free' option not selected.	Select the 'Wrinkle Free' option to rotate the load at the end of the drying cycle. Refer to page 20.

TROUBLESHOOTING

PROBLEM	POSSIBLE CAUSES	WHAT TO DO
Linting.	Lint filter not cleaned or replaced.	Ensure the lint filter is cleaned after every cycle and replaced correctly. Refer to page 23.
	Loads not sorted correctly.	Dry lint givers separately from lint receivers. Also, dry similar colours together eg light coloured items with light coloured items, dark items with dark items. Refer to page 17.
	Clothes over dried.	Over drying clothes in the dryer can cause them to attract lint. Use an auto sensing cycle or ensure you check your load if using the time dry cycles to avoid over drying. Refer to pages 18 and 19.
	New items have been dried in the dryer recently.	Clean the lint filter and use 'Air dry' cycle to clear any remaining lint from the dryer.
	New towels or flannelette sheets can leave lint in the dryer, which may be picked up by subsequent loads.	
Fabric damage.	Instructions on care label not followed.	Follow the instructions on the care label of the items.
	'Dry Temp' or 'Dryness Level' selected not appropriate for the fabric type.	Ensure the 'Dry Temp' and 'Dryness Level' selected is appropriate for the fabric type. Refer to the items care label. Refer to pages 19 and 20.
	Metal parts on the items or in the load.	Fasten zips and other clasps before placing items in the dryer.
	Items not separated or dried on an appropriate cycle for the fabric type.	Dry similar items together. Ensure an appropriate cycle is selected. Refer to pages 15 and 18.
	Items fell off the rack when using 'Rack Dry'.	Ensure the rack is installed correctly (refer to page 17) and only one or two garments are placed on the rack at a time.
	'Dry Temp' or 'Dryness Level' selected not appropriate for the fabric type.	Ensure the 'Dry Temp' and 'Dryness Level' selected is appropriate for the fabric type. Refer to the items care label. Refer to pages 19 and 20.
	Used a 'Time Dry' cycle and did not monitor the dryness of clothes during the cycle.	Ensure that clothes are checked for dryness during the cycle when using the timed programmes to avoid over drying. Refer to page 19.

TROUBLESHOOTING

PROBLEM	POSSIBLE CAUSES	WHAT TO DO
Dye transfer.	White/light and coloured items not separated before drying.	Remember to separate white/light and coloured items before placing them in the dryer.
	Wet items left sitting in the dryer for long periods of time before drying.	Do not leave wet items sitting in the dryer for long periods of time before drying, if they may be prone to colour run. If you do intend to leave them for long periods before drying, then separate the load and put those items that may cause colour run aside.
Tangling.	Loads not separated during loading.	Try separating out larger items from smaller items.
	Items loaded into the dryer incorrectly.	Load items individually into the dryer. Do not place folded items in the dryer.
	Incorrect cycle selection.	Try using the 'Easy Iron' cycle to dry shirts and the 'Sheets' cycle to dry sheets. Refer to pages 15 and 18.
	Load size too large.	Try drying smaller load sizes. Some cycles have a lower maximum load size. Refer to page 18.
	Delicate items not dried on 'Rack Dry'.	Dry pantyhose, bras, stockings and any other delicate items prone to tangling on the 'Rack Dry' cycle with a 'Low' heat setting.
	Sheets and duvet /doona covers due to their size, are prone to tangling.	Dry sheets and duvet/doona covers separately from other laundry, apart from towels. Ensure duvet/doona covers are buttoned or fastened closed before drying. Try adding a knotted towel to sheets loads if you are experiencing a lot of tangling.

MANUFACTURER'S WARRANTY

For New Zealand and Australia only. You automatically receive a 2 year Manufacturer's Warranty with the purchase of this Heat pump clothes dryer covering parts and labour for servicing within the country of purchase.

Fisher & Paykel undertakes to:

Repair or, at its option, replace without cost to the owner either for material or labour any part of the product, the serial number of which appears on the product, which is found to be defective within TWO YEARS of the date of purchase.

Note: this Manufacturer's Warranty is an extra benefit and does not affect your legal rights.

This Manufacturer's Warranty DOES NOT cover

- Ⓐ Service calls which are not related to any defect in the product. The cost of a service call will be charged if the problem is not found to be a product fault. For example:
 - ① Correcting the installation of the product.
 - ② Instructing you how to use the product.
 - ③ Replacing house fuses or correcting house wiring or plumbing.
 - ④ Correcting fault(s) caused by the user.
 - ⑤ Noise or vibration that is considered normal, eg drain/fan sounds, machine noises or user warning beeps.
 - ⑥ Correcting damage caused by pests, eg rats, cockroaches, etc.
 - ⑦ Poor drying performance due to incorrect installation and maintenance eg blocked lint filter, blocked condenser or full water tank.
 - ⑧ Poor drying performance due to incorrect loading, eg overloading or underloading.
 - ⑨ Damage from articles in the drum, eg bra wires, pens, crayons, dye transfer or flammable material.
- Ⓑ Defects caused by factors other than:
 - ① Normal domestic use; or
 - ② Use in accordance with the product's user guide.
- Ⓒ Defects to the product caused by accident, neglect, misuse or 'act of God'.
- Ⓓ The cost of repairs carried out by non-authorized repairers or the cost of correcting such unauthorised repairs.
- Ⓔ Normal recommended maintenance as set out in the product's user guide.
- Ⓕ Repairs when the appliance has been dismantled, repaired or serviced by other than a Fisher & Paykel Authorised Repairer or the selling dealer.
- Ⓖ Pick-up and delivery.
- Ⓗ Transportation or travelling costs involved in the repair when the product is installed outside the Fisher & Paykel Authorised Repairer's normal service area.

Nothing in this Manufacturer's Warranty is intended to, or does, limit any rights you may have under law to recover the costs of inspecting or returning the goods to us.

This product has been designed for use in a normal domestic (residential) environment. This product is not designed for commercial use (whatsoever). Any commercial use by a customer will affect this product's Manufacturer's Warranty.

MANUFACTURER'S WARRANTY

Service under this Manufacturer's Warranty must be provided by a Fisher & Paykel Authorised Repairer (refer to the 'Customer Care' section at the back of this book). Such service shall be provided during normal business hours. This Manufacturer's Warranty certificate should be shown when making any claim.

For Australian Customers

This Manufacturer's Warranty is an extra benefit and does not affect your legal rights. Our goods come with guarantees that cannot be excluded under the Australian Consumer Law. You are entitled to a replacement or refund for a major failure and for compensation for any other reasonably foreseeable loss or damage. You are also entitled to have the goods repaired or replaced if the goods fail to be of acceptable quality and the failure does not amount to a major failure.

Please keep this user guide in a safe place.

CUSTOMER CARE

Before you call for service or assistance...

Check the things you can do yourself. Refer to your user guide and check:

- ① Your product is correctly installed.
- ② You are familiar with its normal operation.
- ③ You have read the 'Before you call for service', 'Fault codes' and 'Troubleshooting' sections at the back of the book.

If after checking these points you still need assistance or parts, please refer to your nearest Authorised Service Centre, Customer Care, or contact us through our website www.fisherpaykel.com.

In New Zealand if you need assistance...*

Call your Fisher & Paykel retailer who is trained to provide information on your appliance, or if we can be of any further help, please contact our Customer Care Centre.

Toll Free: 0800 FP CARE or 0800 372 273

Fax: (09) 273 0656

Website: www.fisherpaykel.com

Postal address: Fisher & Paykel Appliances Ltd, PO Box 58550, Botany, Auckland 2163

If you need service...*

Fisher & Paykel has a network of independent Fisher & Paykel Authorised Repairers whose fully trained technicians can carry out any service necessary on your appliance. Your dealer or our Customer Care Centre can recommend a Fisher & Paykel Authorised Repairer in your area.

In Australia if you need assistance...*

Call the Fisher & Paykel Customer Care Centre and talk to one of our Customer Care Consultants.

Toll Free: 1300 650 590

Fax: (07) 3826 9298

Website: www.fisherpaykel.com

Postal address: Fisher & Paykel Appliances Ltd, PO Box 798, Cleveland QLD 4163

If you need service...*

Fisher & Paykel has a network of Fisher & Paykel trained and supported service technicians responsible for servicing only Fisher & Paykel branded appliances. Our Customer Care Centre can recommend a Fisher & Paykel trained and supported service technician in your area.

*If you call, write or contact our website please provide: your name and address, model number, serial number, date of purchase and a complete description of the problem. This information is needed in order to better respond to your request for assistance.

Product details can be found on the rear of the machine, and/or on the inside of the door below the glass (when the door is open).

CUSTOMER CARE

Registration

Register your product with us so we can provide you with the best service possible.

To register your product visit our website:

www.fisherpaykel.com

Complete and keep for safe reference:

Model _____

Serial No. _____

Purchase Date _____

Purchaser _____

Dealer _____

Suburb _____

Town _____

Country _____

www.fisherpaykel.com

Copyright © Fisher & Paykel 2015. All rights reserved.
The product specifications in this booklet apply to the specific products and models described at the date of issue. Under our policy of continuous product improvement, these specifications may change at any time. You should therefore check with your dealer to ensure this booklet correctly describes the product currently available.

NZ AU

428104 A 08.15