

Silver Cross®

THE BEST START IN LIFE

Pioneer Pushchair & Carrycot



**IMPORTANT: KEEP THESE INSTRUCTIONS
FOR FUTURE REFERENCE**

1.1

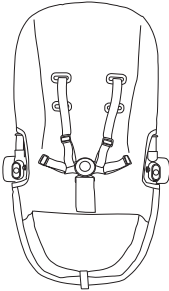

1.2



1.3

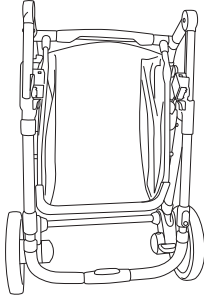

1.4

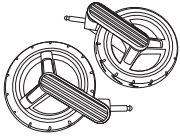

1.5



1.6

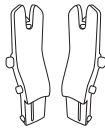

1.7



1.8

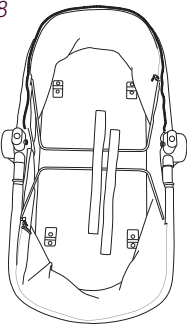

1.9

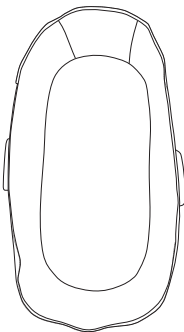

1.10

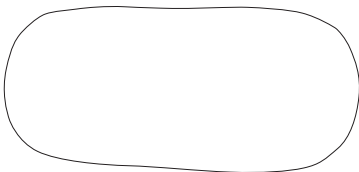

These instructions are important.

Read these instructions before use and keep them for future reference. Your child's safety may be affected if you do not follow these instructions.

Your Pioneer Pushchair is a high quality Silver Cross product. It meets current British and European safety standards and care and regular light maintenance will ensure long service.

This pushchair is suitable from birth up to 9kg with the Carrycot and from 6 months up to 25 kg using the Seat Unit.

If somebody unfamiliar is using your Pioneer Pushchair always ensure that they read these instructions carefully so that they understand how the product works best.

The Pioneer Pushchair is designed and tested to be used with the Simplicity Car Seat and the Pioneer Carrycot.

Always read all the instructions provided carefully and remember, the safety of your child is your responsibility.

WARNING: Never leave your child unattended.

Contents

First check all your parts have been supplied. Your Pioneer pushchair includes:

- 1.1 Seat unit with harness
- 1.2 Bumper bar
- 1.3 Chassis
- 1.4 Front Wheels
- 1.5 Rain Cover
- 1.6 Simplicity Car Seat Adaptors
- 1.7 Cup Holder
- 1.8 Carrycot outer
- 1.9 Carrycot liner
- 1.10 Carrycot mattress

2.1

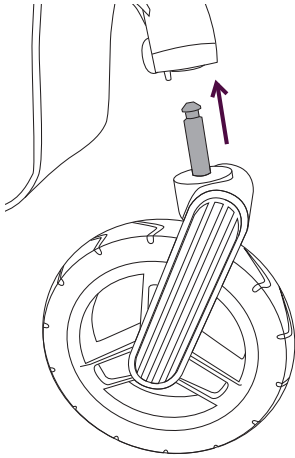

Preparation for use

Remove all packaging material from your Pioneer pushchair. To use your Pioneer pushchair from birth you must use the Pioneer Carrycot (included)

WARNING: Check that the carrycot or seat unit or car seat attachment devices are correctly engaged before use.

Pioneer chassis

- 2.1 Attach the front wheels by inserting the axles into the Pioneer frame until they 'click' into position.
- 2.2 Release the folding lock and lift the handle upwards.

2.2

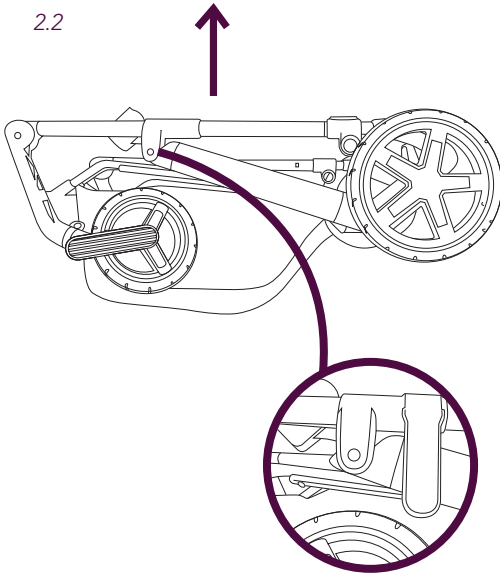

2.3

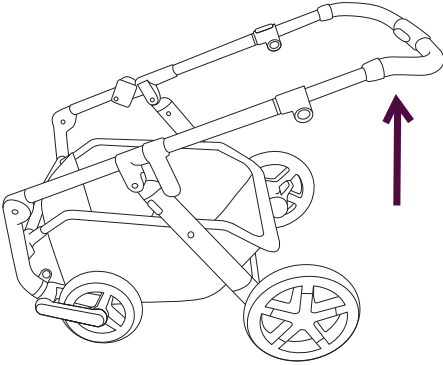

Pioneer chassis

- 2.3 Continue to lift the handle upwards until the frame 'clicks' and locks into position. Always check that the frame is secure.
- 2.4 Apply the brake (see 22.1) and adjust the handle height by pushing the adjustment button in. Slide the handle up or down and release the adjustment button. The handle will 'click' and lock into position (see 24.1).

Your Pioneer chassis is now ready for use.

2.4

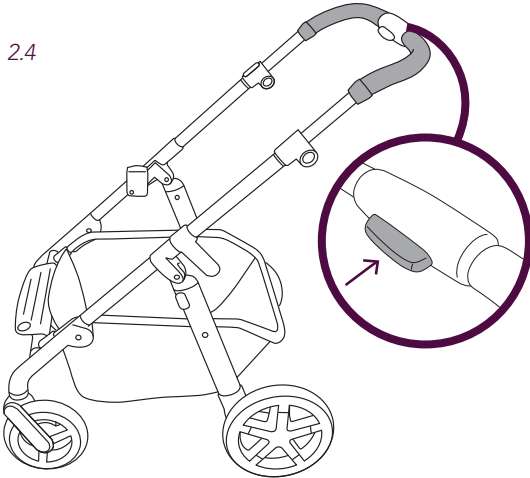

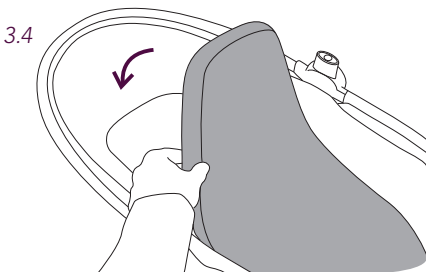
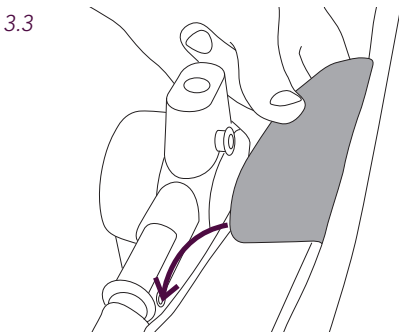
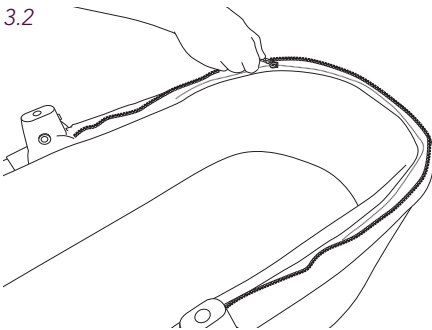
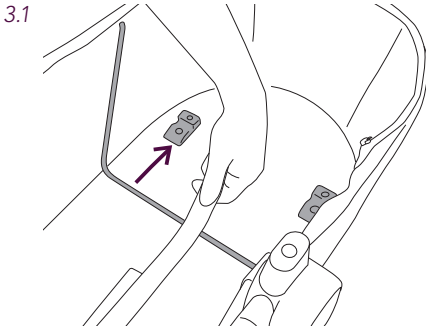

Using your Pioneer from birth with the carrycot

Preparation for use

Remove all packaging material from your Pioneer carrycot.

- 3.1 First erect the carrycot outer. Lay the carrycot outer down with the frame upper most. Press the 2x metal bars into the locators on internal base of carrycot. A small groove in the locator holds the frame in position.
- 3.2 Attach the carrycot liner to the carrycot outer. Fasten each inner zip. There is one at each end of the liner.
- 3.3 Pass the two D-shaped parts of the liner between the liner and the outer and fasten the Velcro patches to secure the liner in place.
- 3.4 Place the mattress into the base of the liner.

WARNING: Do not leave your child unattended.

WARNING: Never use the carrycot on a stand.

WARNING: Do not let other children play unattended near the carrycot.

3.5

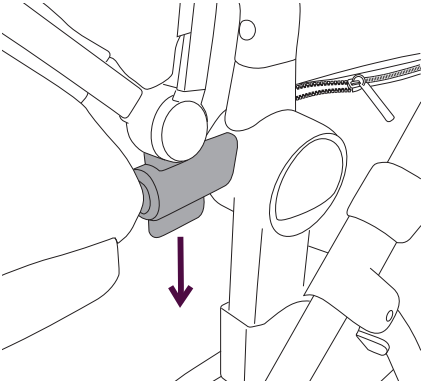

Using your Pioneer from birth with the carrycot

- 3.5 Attach the hood by pressing the hood clips onto the slots on either side of the carrycot frame. Slide the back of the Pioneer hood over the rear edge of the carrycot.
- 3.6 To fit the apron, unzip the lower edge of the apron and keep it in a safe place. Zip the apron onto the carrycot outer.

3.6

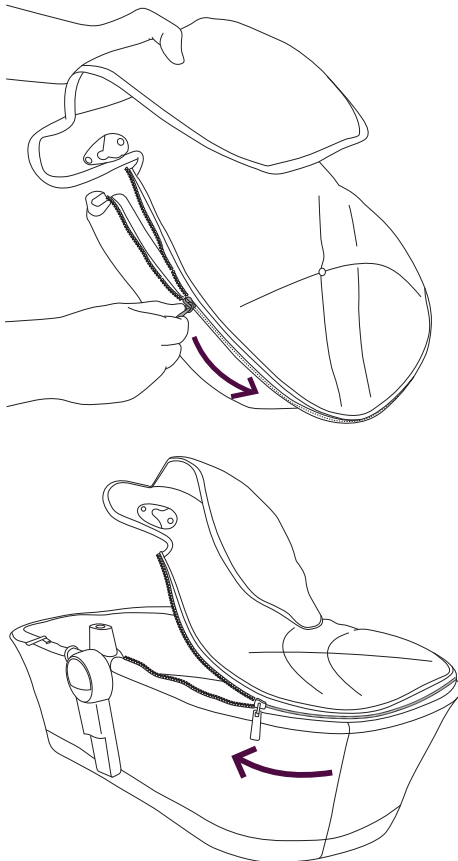

3.7

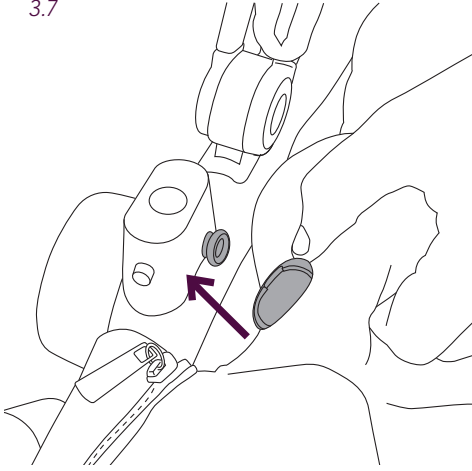

Using your Pioneer from birth with the carrycot

3.7 Slide the apron flap clips over the attachment points inside the carrycot frame.

3.8 Attach the bumper bar by pressing the ends of the bumper bar into the attachment points of the carrycot frame. Wait to hear them 'click' into place. Lift gently to ensure the bumper bar is locked in place. Fold the apron flap over the bumper bar to hold it in place.

WARNING: The bumper bar must be securely connected at all times when in use. The safety of your child is your responsibility.

Your Pioneer carrycot is ready to use.

3.8

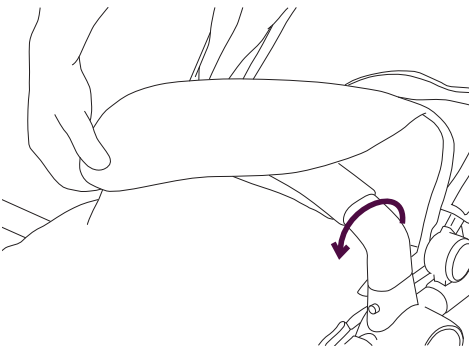
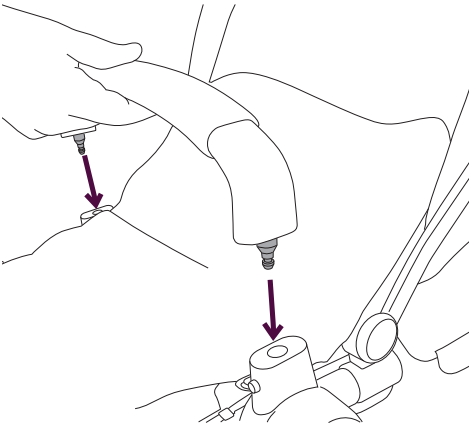

4.1

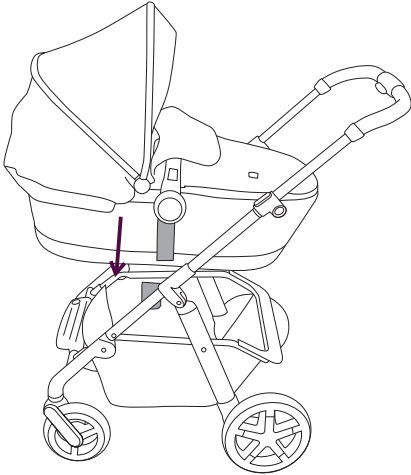

Attaching the carrycot to your chassis

- 4.1 To attach your Pioneer carrycot to the Pioneer chassis hold the carrycot above the chassis. Locate the carrycot chassis connector posts into the attachment slots on the chassis. Ensure that the carrycot 'clicks' into place. The carrycot should be fitted rearward facing. Lift the carrycot gently by the bumper bar to check the carrycot has locked into place.

WARNING: Do not add a mattress other than the one provided.

WARNING: Never use this carry cot on a stand.

Detaching the carrycot from your chassis

5.1

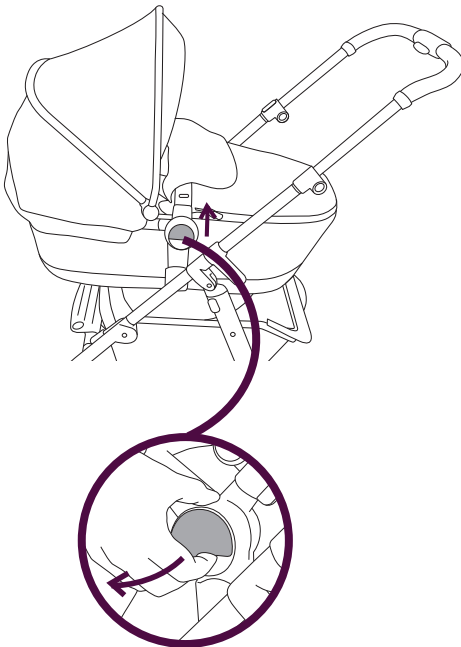

- 5.1 With the Pioneer carrycot facing you, pull both carrycot release handles outwards and lift the carrycot clear of the chassis.

WARNING: Always ensure your bumper bar is attached when your child is in the carrycot.

WARNING: This product is suitable for a child who cannot sit up by itself, roll over and can not push its self up on its hands and knees. Max weight of child: 9kg.

WARNING: Do not let other children play unattended near the carrycot.

WARNING: Do not use if any part is broken, torn, or missing.

CAUTION: Only use replacement parts supplied and approved by the manufacturer.

6.1

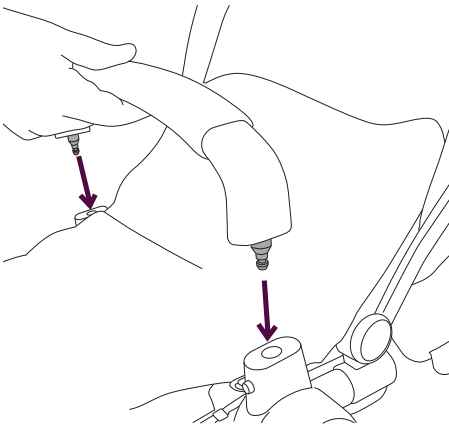

Using your bumper bar

- 6.1 To attach, simply press both ends of the bumper bar into the connector points on the carrycot. Wait for it to 'click' in place.
- 6.2 To detach, press the bumper bar release button on the carrycot frame with one hand and pull the bumper bar away from the connector point with the other hand. The bumper bar will rotate.

To detach both sides repeat point (6.2) above. With one side of the bumper bar removed the carrycot is easily accessible.

WARNING: The bumper bar must be securely connected at all times when in use. The safety of your child is your responsibility.

6.2

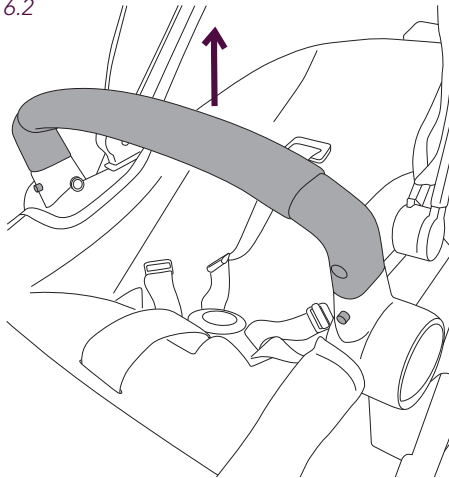

7.1

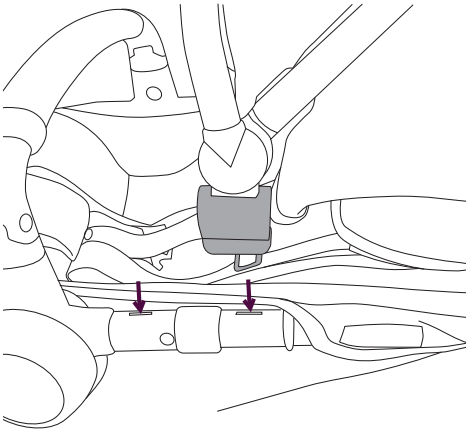

Using your hood

- 7.1 Attach the hood by pressing the hood clips onto the slots on either side of the carrycot frame. Slide the back of the Pioneer hood over the rear edge of the carrycot. Your Pioneer hood can be attached in 2 positions.
- 7.2 Your Pioneer hood can be used in 3 positions. Fully open, semi-open and fully covered.

7.2

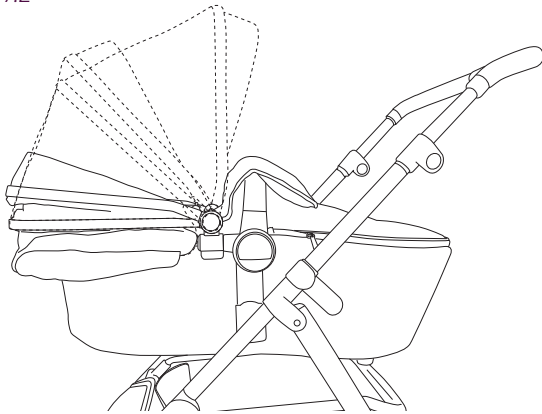

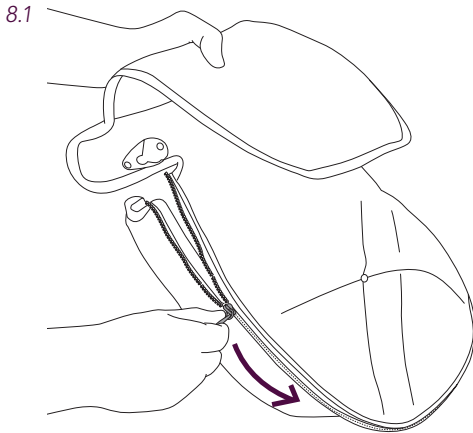

Using your apron

8.1 To attach the apron, unzip the lower edge of the apron and keep it in a safe place. Zip the apron onto the carrycot outer.

8.2 Slide the apron flap clips over the attachment points inside the carrycot frame.

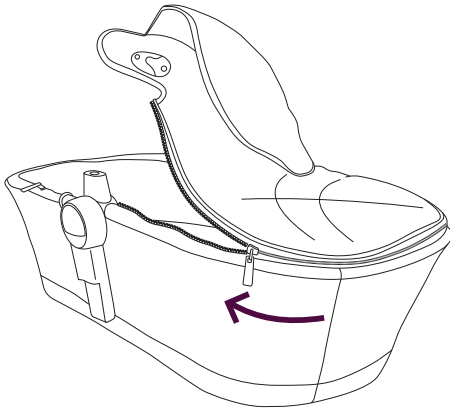

8.2

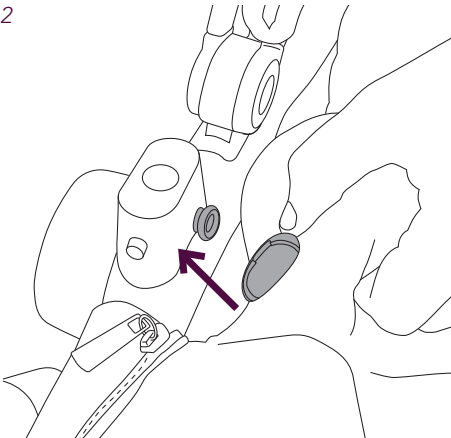

9.1

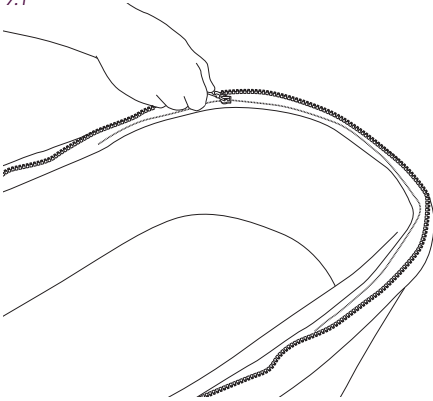

Using your liner and mattress

- 9.1 Your Pioneer Carrycot mattress is removable. Simply lift it out of the liner. The mattress cover can be hand washed. Remove the foam mattress insert prior to washing by opening the flap on the back of the mattress cover and removing the foam mattress.
- 9.2 The Pioneer Carrycot has a removable liner. Simply unzip each end and release the Velcro fastenings to remove it.

To fit the liner and mattress see preparation for use (3.2 and 3.3)

9.2

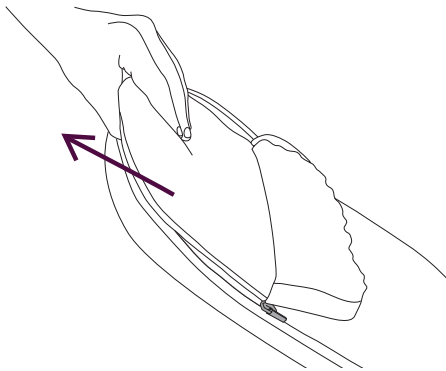

Using your raincover

- 10.1 Your Pioneer raincover should be used when the Pioneer hood is attached to the carrycot. First slide over the hood and down towards the foot of the carrycot.

Velcro fastenings secure the sides around the chassis.

A zip gives easy access to your child.

10.1

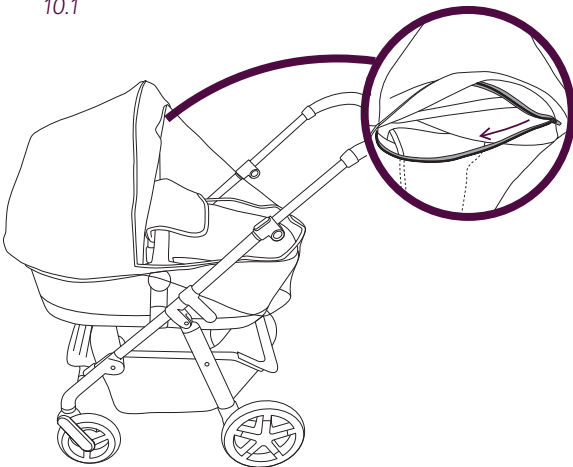

11.1

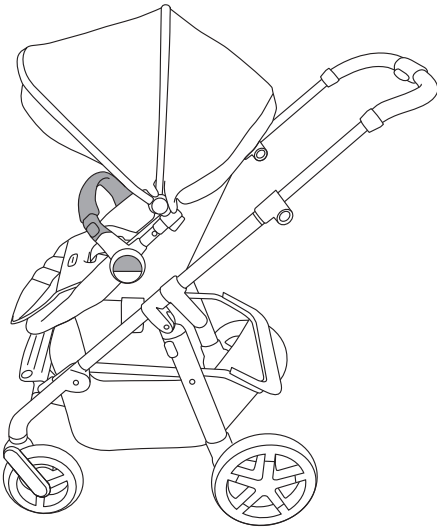

Using your Pioneer as a pushchair

11.1 Your Pioneer seat unit can be fitted to the chassis in rearward facing position (infant facing you) or forward facing position (infant facing away from you). Follow (13.1) to attach the seat unit to the chassis.

Adjust the seat unit to the desired position (see 20.1) Secure the apron (see 17.1).

Your Pioneer pushchair is ready to use.

Preparing the seat unit

12.1 First, slide the back of the hood over the back of the seat unit. Locate the slot in the fabric at the back of the hood and slide over the seat recline adjustment lever.

12.1

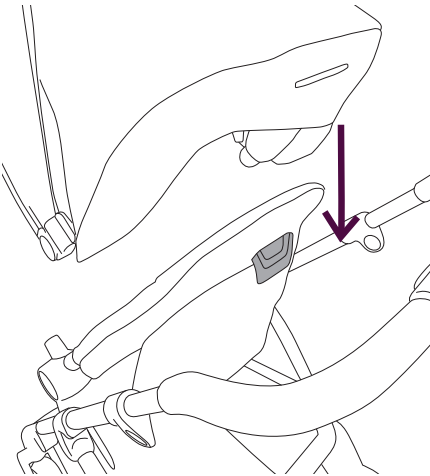

12.1

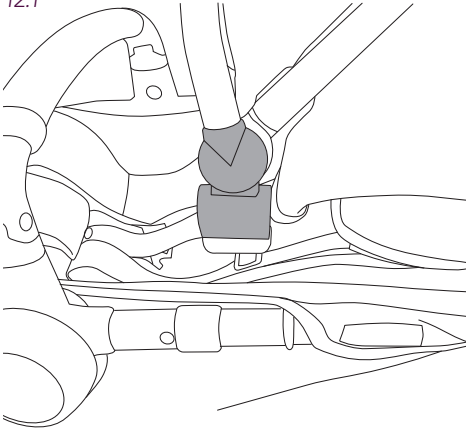

Preparing the seat unit

12.2 Attach the hood by pressing the hood clips onto the slots on either side of the seat unit frame. Note your Pioneer pushchair has a function where you have the option to raise or lower the height of the hood provided. The height position can be selected simply by connecting the hood to one of the two height locations provided. Velcro the lower front corners of the hood onto the seat unit.

12.3 Simply thread the harness through the button holes in the seat unit relative to the size of your child, and secure the harness buckle. (see 15.1).

12.2

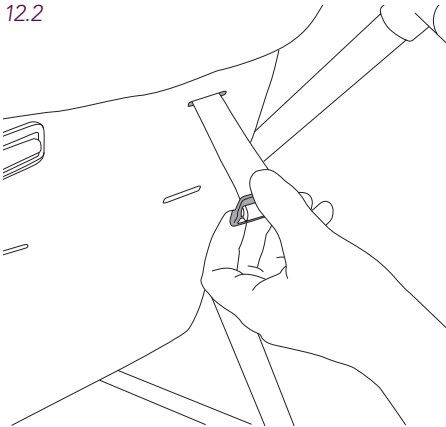

12.3

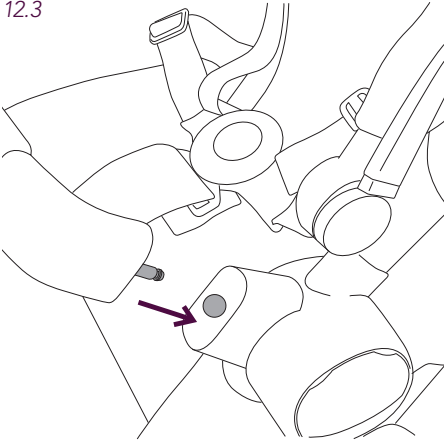

Preparing the seat unit

- 12.3 Fit the bumper bar to the seat unit by placing the metal ends of the bumper bar into the fixing points on the seat unit. Wait to hear the bumper bar 'click' into place.

WARNING: Always ensure your bumper bar is attached when your child is in the seat unit.

- 12.4 Slide the apron flap clips onto the attachment points on the inside of the seat frame. Fold the apron flap over the bumper bar to enclose and secure your child. To secure, release and adjust the harness (see 15.1)

12.4

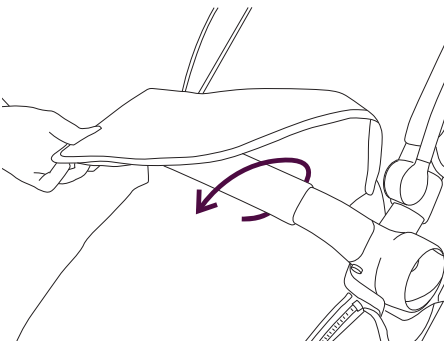
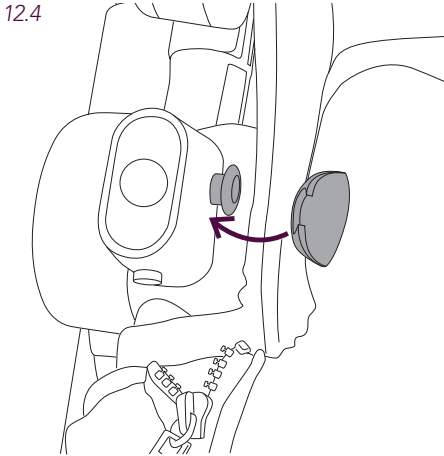

13.1

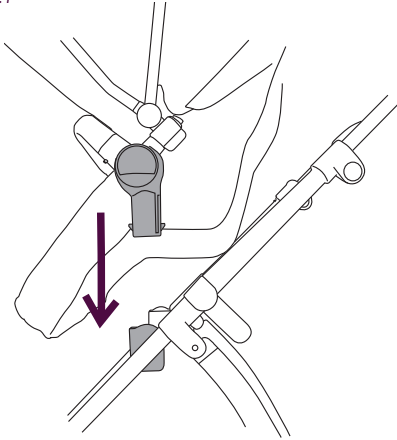

Attaching the seat unit to your chassis

WARNING: Ensure all locking devices are engaged before use.

- 13.1 To attach your Pioneer seat unit to the Pioneer chassis hold the seat unit above the chassis. Locate the seat unit chassis connector posts into the seat attachment slots on the chassis. Ensure that the seat unit 'clicks' into place. The seat unit can be fitted forward or rearward facing. Lift the seat unit gently by the bumper bar to check the seat unit has locked into place. To adjust the seat position (see 20.1)

14.1

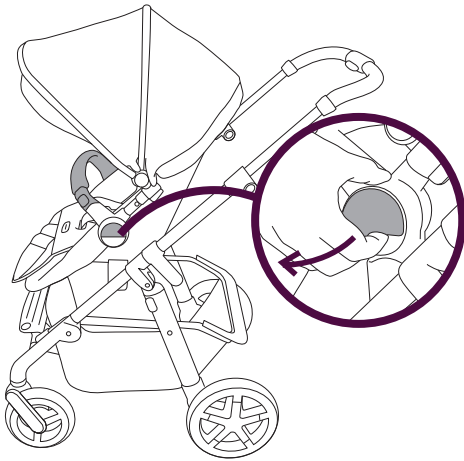

Detaching the seat unit from your chassis

- 14.1 With the seat unit facing you, pull both seat release handles outwards and lift the seat unit clear of the chassis.

WARNING: Always ensure your bumper bar is attached when your child is in the seat unit.

NOTE: Remove the child from the seat unit before detaching from your chassis.

15.1

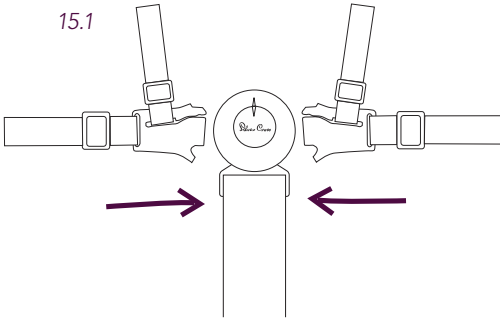

15.2

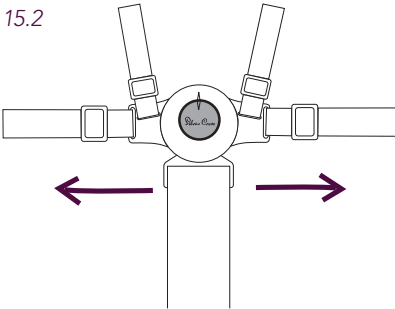

15.3

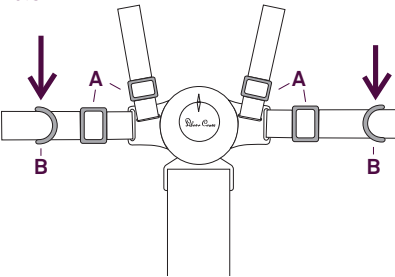

15.4

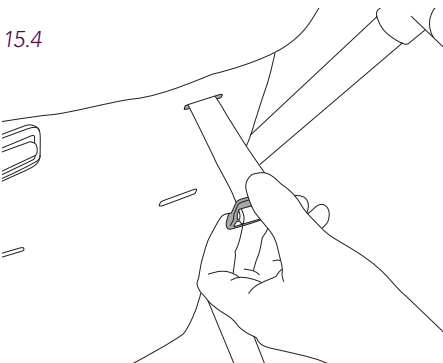

Using the harness

WARNING: Always use the crotch strap in combination with the waist and shoulder straps

15.1 To fasten the harness insert both buckle clips into each side of the buckle. Listen for the 'click'.

WARNING: Always use the restraint system.

15.2 To release the harness press the button at the centre of the buckle and pull apart. The shoulder straps can be unhooked from the buckle if required.

15.3 Your harness is fully adjustable by moving the slides (A), to make fitting easy. Your child should always be harnessed in and should never be left unattended, even for short periods of time.

Your Pioneer harness can be adjusted for the size of your child.

15.4 The shoulder straps have 3 height positions. To adjust, first lift the flap on the back of the seat unit. Thread the harness buckle from the front of the seat unit through to the back of the seat unit and allow the buckle to lay flat behind the seat securing the shoulder strap in place.

16.1

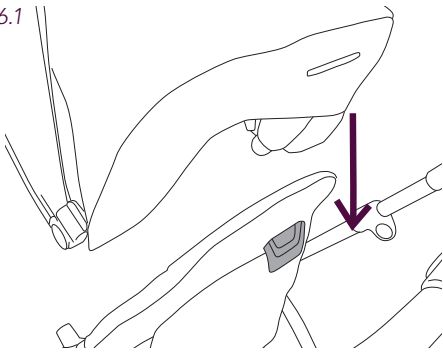

Using your hood

- 16.1 Attach the hood by pressing the hood clips onto the slots on either side of the seat frame. Slide the back of the Pioneer hood over the rear edge of the seat unit.
- 16.2 Your Pioneer hood can be used in 3 positions. Fully open, semi-open and fully covered.

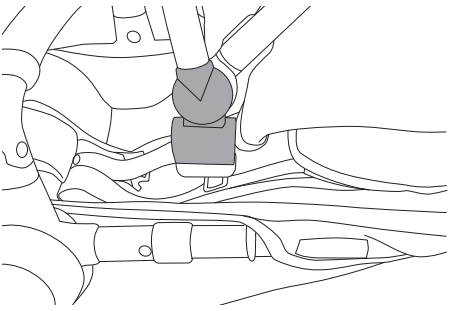

16.2

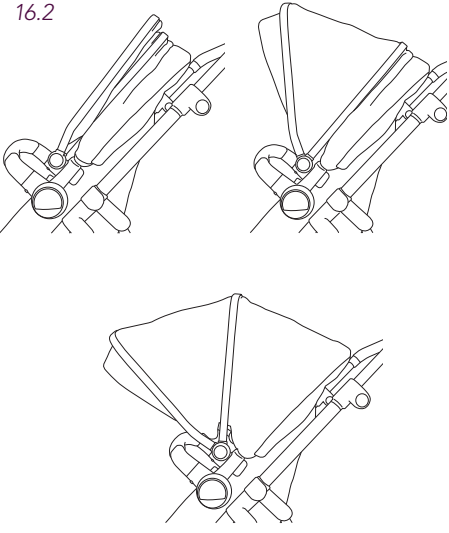

17.1

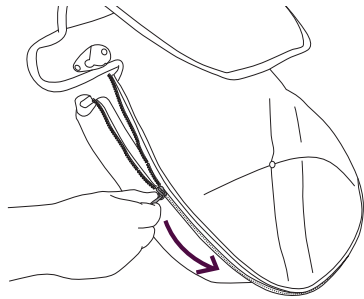
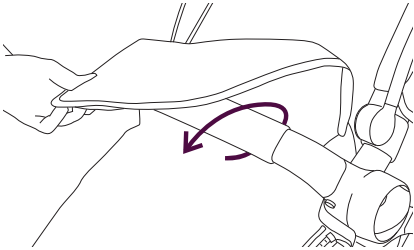
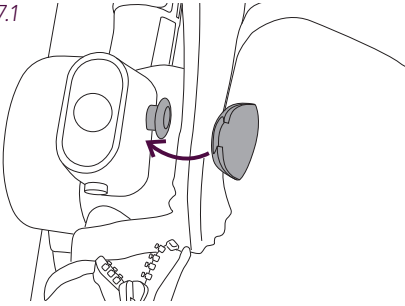

18.1

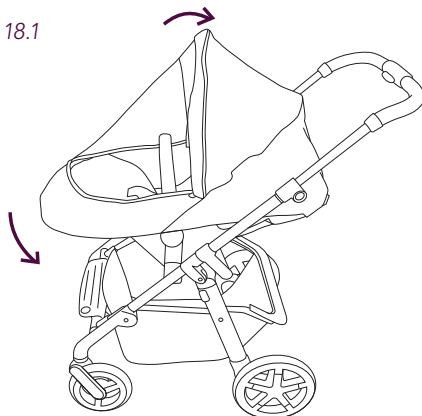

Using your apron

- 17.1 Slide the apron flap clips onto the attachment points on the inside of the seat frame. Fold the apron flap over the bumper bar to enclose and secure your child.

Using your raincover

- 18.1 Your Pioneer raincover should be used when the Pioneer hood is attached to either the seat unit or carrycot. First slide over the hood and down towards the toe of the seat unit or carrycot. Velcro fastening secures the raincover under the foot of the seat unit or carrycot.

A zip gives easy access to your child.

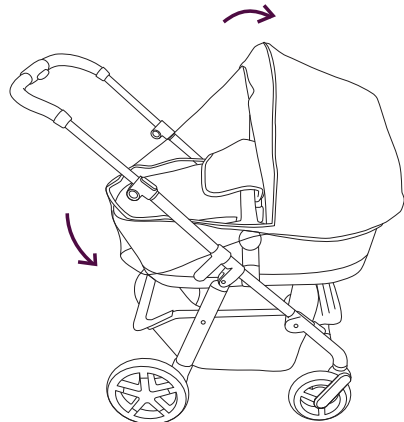

19.1

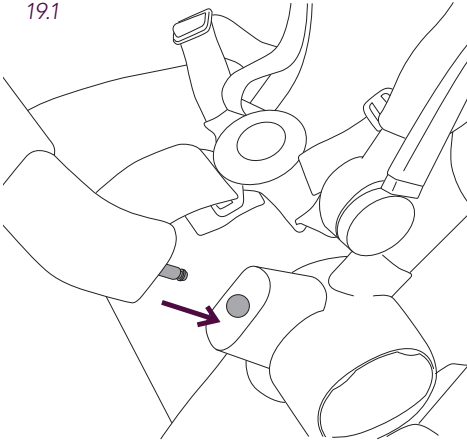

Using your bumper bar

Your Pioneer seat unit has a bumper bar that can be fully or partly removed

WARNING: Always ensure your bumper bar is attached when your child is in the seat unit.

- 19.1 Fit the bumper bar to the seat unit by placing the metal ends of the bumper bar into the fixing points on the seat unit. Wait to hear the bumper bar 'click' into place.
- 19.2 To detach, press the bumper bar release button on the seat unit with one hand and pull the bumper bar away from the fixing point with the other hand. The bumper bar will rotate allowing easy access to your child, if the bumper bar needs to be fully removed then repeat on the opposite side.

19.2

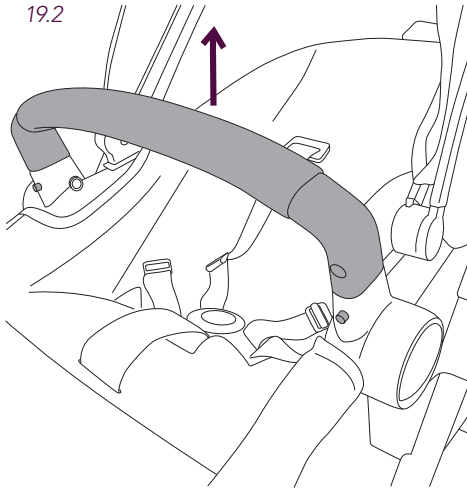

WARNING: Always remove your child from the seat before attempting to lift and remove the seat unit.

20.1

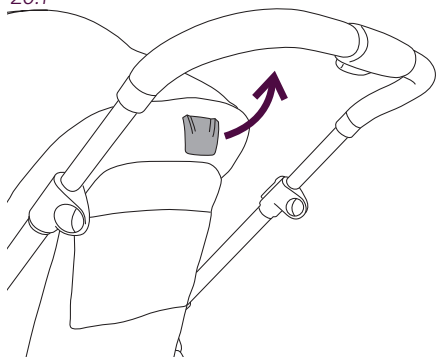

Adjusting the seat position

Your Pioneer has 3 forward facing and 3 rearward facing seat positions

20.1 To adjust the seat position in either forward or rearward facing mode, lift and hold the seat recline adjustment lever on the back of the seat unit. Move the seat unit upwards or downwards to upright, semi-recline or full recline. Release the recline adjustment lever and wait to hear a 'click' for each position to lock into place.

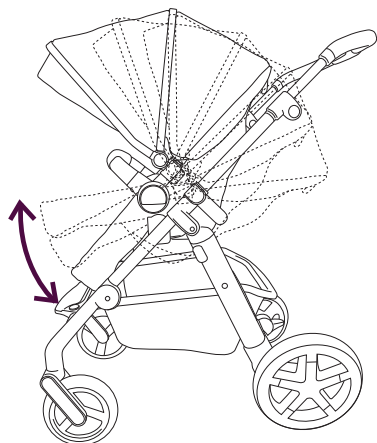

20.2 Your Pioneer has an adjustable multi-position footrest.

To adjust the footrest, press the adjuster buttons located on each side of the footrest. Once buttons are pressed gently adjust the footrest to its lowest position. Once in the lowest position you can gently lift the footrest up to a more desired position if required.

20.2

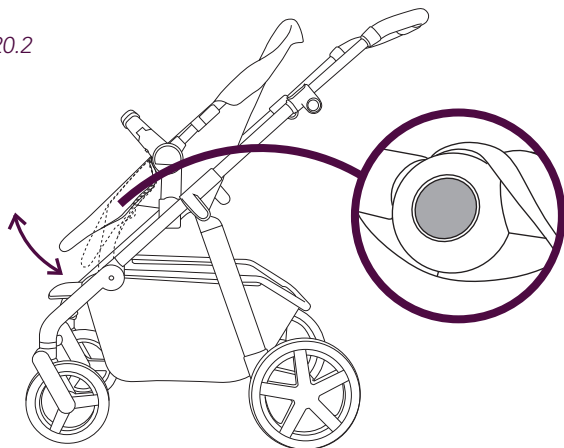

21.1

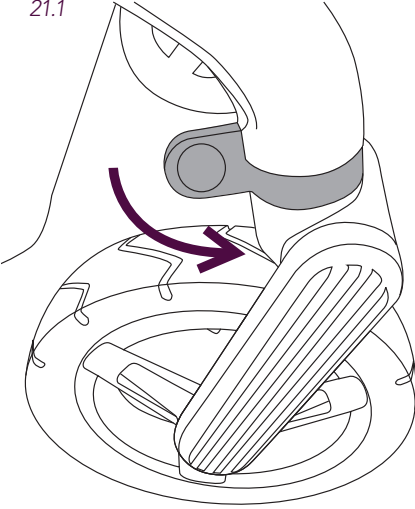

Folding your Pioneer chassis

NOTE: To ensure your Pioneer chassis folds correctly remove all items from the shopping basket before attempting to fold.

NOTE: If using as a travel system (with a car seat) or pram (with Pioneer carrycot) please ensure each part has been removed before folding.

Your Pioneer chassis can be folded with the seat unit attached and in forward facing, upright position. In all other positions it is recommended to remove the seat unit.

21.1 Ensure the swivel wheels are locked (see 23.1)

21.2 Engage the brake pedal (see 22.1)

21.2

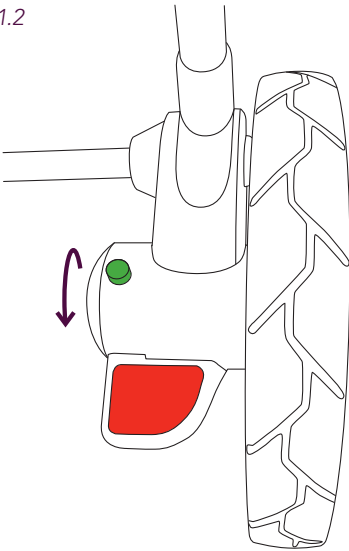

21.3

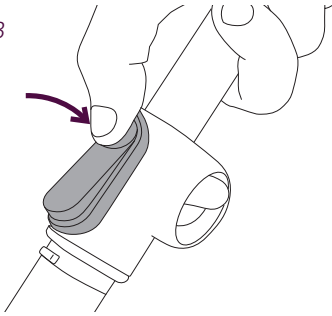

Folding your Pioneer chassis

- 21.3 Press and hold the fold release button. Pull the fold release triggers towards you. Push the handle downwards gently and lower the handle downwards until the fold lock engages. Lift the handle upwards gently to ensure that the chassis is folded correctly.

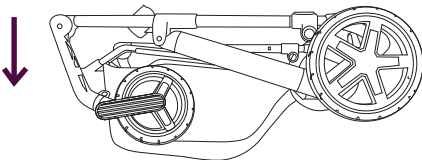
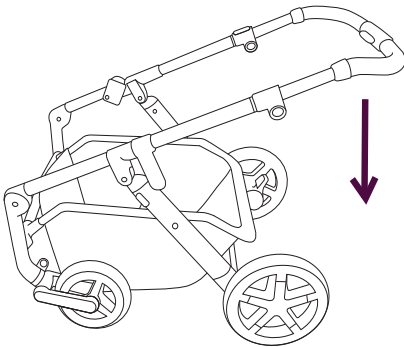
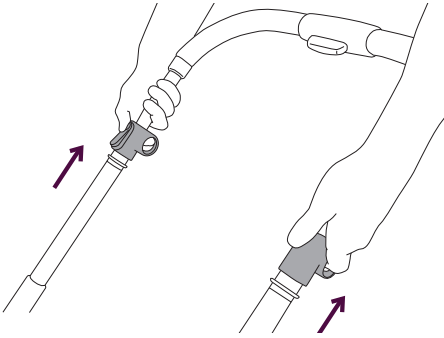

22.1

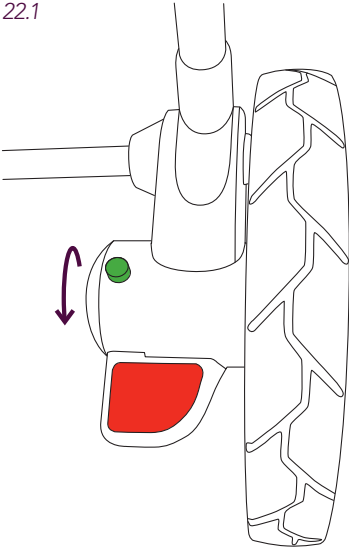

Using the brake

WARNING: Always apply the parking brake when you are standing still.

WARNING: Always apply the break when placing and removing the child.

22.1 To engage the brake, press down on the red brake pedal. Listen for the 'click'.

NOTE: Always check that your brake is fully engaged by gently rocking the pushchair.

22.2 To disengage the brake, gently press down on the green brake release button. Rock the pushchair backwards before moving forward.

23.1

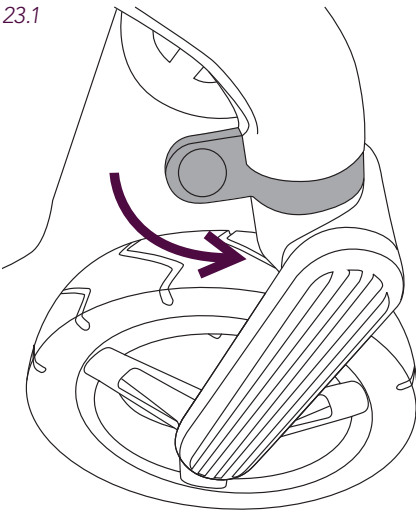

Operating the swivel wheels

Your Pioneer chassis has lockable front swivel wheels. We advise locking the front wheels if pushing the pushchair straight ahead for a long period.

23.1 Rotate the swivel release lever sideways to lock the wheels into the fixed position.

Always apply brake when placing and removing children.

24.1

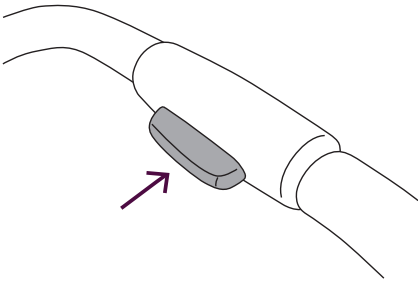

Operating the height adjustable handle

Your Pioneer has a 4 position handle height.

- 24.1 Press and hold the handle height adjustment /folding button and slide the handle down to its lowest point.
- 24.2 Slide the handle up or down to required height and release the adjustment button. The handle will lock and 'click' into place.

24.2

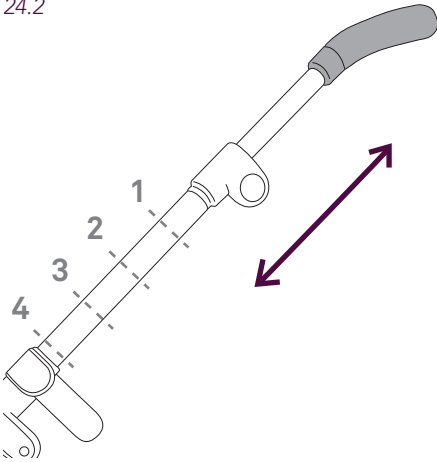

25.1

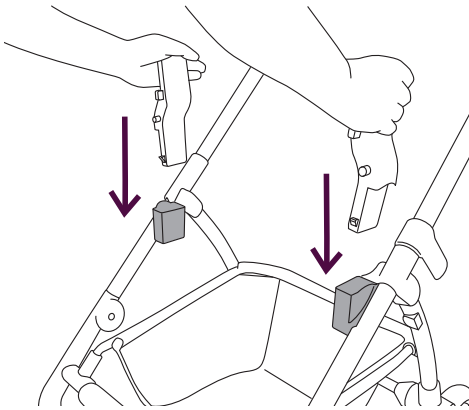

25.2

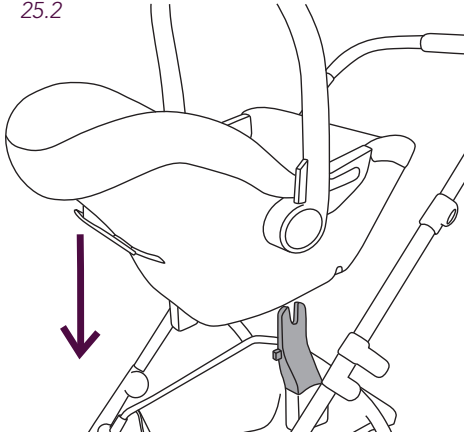

Using your Pioneer chassis with the Simplicity Infant Carrier

- 25.1 To attach your Pioneer Simplicity Adaptors, locate the adaptors onto the chassis attachment posts on both sides. Ensure the adaptors 'click' into place.

WARNING: Standing behind the Pioneer handle, ensure the adaptor corresponding adaptors are located in the correct slots. Using the wrong adaptors can cause damage to them.

- 25.2 Place the Simplicity Infant Carrier onto the adaptors. Ensure the Simplicity 'clicks' into place. Lift the Simplicity gently by the carry handle to check the Simplicity has locked into place.

WARNING: Check that the Simplicity attachment devices are correctly engaged before use.

26.1

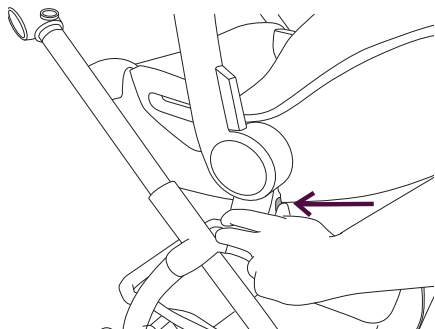

Detaching the Simplicity from the chassis

26.1 With the Simplicity Infant Carrier facing you, first press the silver button on the front of the Right Hand Side adaptor until it clicks into place.

26.2 Then while pressing and holding the other silver button on the front of the Left Hand Side adaptor, lift the Simplicity from the chassis using the carry handle.

26.2

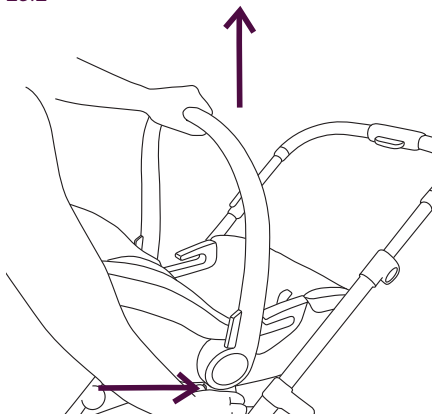

Removing the Simplicity Adaptors from the chassis

27.1 For both adaptors, press the circular button on the side of the adaptor and pull adaptor upwards to release from chassis.

WARNING: Do not remove the Simplicity Infant Carrier with the adaptors still attached to the Simplicity.

WARNING: Your Simplicity Infant Carrier should always be rearward facing.

NOTE: This car seat does not replace a cot or bed. Should your child need to sleep then it should be placed in a suitable pram body or cot.

27.1

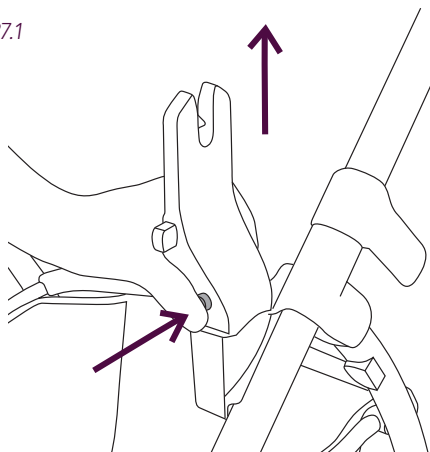

Safety Notes

Your Pioneer Pushchair is a high quality Silver Cross product. It complies with BS EN: 1888:2012 and with correct use and maintenance will give good service. If, however you should have any problems with your pushchair, please contact your Silver Cross retailer who will take appropriate action. Pioneer carrycot complies with BS EN: 1466:2004.

WARNING:

Never leave your child unattended.

To avoid injury ensure that your child is kept away when folding and unfolding this product.

Ensure that all locking devices are engaged before use.

Do not carry more than one child in this pushchair.

This product is not suitable for running or skating.

Ensure the parking devices are engaged when placing and removing your child.

Check that the pram body or seat unit, or car seat attachment devices are correctly engaged before use.

Do not let your child play with this product.

Do not let other children play unattended near the carry cot. The carry cot is only suitable for a child who cannot sit up unaided.

This seat unit is not suitable for children under 6 months.

Always use the restraint system.

Never use the carry cot on a stand.

Do not use if any part is broken, torn or missing.

Be aware of the risk of open fires, gas fires etc. in the near vicinity of the carrycot.

The handles and the bottom of the carry cot should be checked regularly for signs of damage and wear.

Only the mattress provided should be used with the carry cot.

Car seats do not replace a cot or bed. Should your child need to sleep, then it should be placed in a suitable pram body, cot or bed.

Any load attached to the handle and/or backrest and/or sides of the vehicle will affect stability of the vehicle. A baby's safety is your responsibility.

The child should always wear a safety harness complying with BS6684. 'D' rings are provided for the attachment of an additional harness.

These are located on the existing harness close to where it is attached to the seat frame. Do not hang shopping bags or other objects from the handle. This may cause the pushchair to tip up. Extra shopping or luggage should only be carried in the basket and should not exceed 5kg in weight, evenly distributed. Always hold the seat when making adjustments. Ensure that the brake is on.

Never try to fold your Pioneer when the child is seated as this may trap the child. If you have difficulty in folding or unfolding the pushchair, do not force. This will cause damage. Read the "To fold or unfold" instructions carefully in the Pioneer Instructions. It may be unsafe to fit accessories or spare parts other than those supplied or recommended by Silver Cross. If anyone other than the owner is going to use the Pushchair (e.g. grandparent, child minder), please show them how to use it correctly.

The Pioneer seat unit and Pioneer carrycot should only be used on the Pioneer chassis.

Caution: The child should be clear of moving parts while making adjustments.

Never leave your child in the pushchair with the raincover fully fitted other than in normal outside use.

Changing Bag: Maximum load = 1kg (sold separately)

Cup holder: Maximum load = 0.5kg

Only accessories and replacement parts approved by Silver Cross should be used.

Care and Maintenance

Chassis

Always check your pushchair for signs of wear. Regularly lubricate all moving parts. Check for freedom of movement of all locking devices. Polish metal work with a clean, dry cloth.

Fabric items and seat unit

For fabric wash care instructions please refer to the care guide included with your pram. Keep away from direct heat and strong sunlight. A certain degree of fading may occur over time through everyday use. Never machine wash, tumble dry, iron or bleach.

Never leave accessories such as the Sunshade or raincover where heat and light may discolour the fabrics or distort the plastics, e.g. on the car parcel shelf in hot weather.

Guarantee

All Silver Cross products are guaranteed for a period of 12 months against faulty workmanship, when the product is used correctly according to the instruction manual.

Please read these instructions carefully before using your new Pioneer Pushchair and keep for future reference.

www.silvercross.co.uk

Telephone: 0845 872 6900

Consignes de sécurité

Votre poussette Pioneer est un produit de haute qualité de Silver Cross. Elle est conforme à la norme BS EN: 1888:2012 et, si elle est utilisée et entretenue correctement, elle offrira un service de qualité. Si vous deviez toutefois rencontrer le moindre problème avec votre poussette, veuillez contacter votre revendeur Silver Cross pour qu'il prenne les mesures adéquates. La nacelle Pioneer est conforme à la norme BS EN: 1466:2004.

AVERTISSEMENT :

Ne laissez jamais votre enfant sans surveillance.

Pour éviter les blessures, maintenez votre enfant à l'écart lorsque vous pliez et dépliez ce produit.

Assurez-vous que tous les dispositifs de verrouillage sont enclenchés avant utilisation.

Ne transportez pas plus d'un enfant dans cette poussette.

Ce produit n'est pas conçu pour faire du jogging ou des promenades en rollers.

Assurez-vous que les freins sont actionnés lorsque vous positionnez et retirez votre enfant.

Vérifiez que les dispositifs de fixation de la nacelle, du siège ou du siège auto sont correctement enclenchés avant utilisation.

Ne laissez pas votre enfant jouer avec ce produit.

Ce produit est conçu uniquement pour les enfants qui ne peuvent pas s'asseoir tout seuls.

Ce siège n'est pas conçu pour les enfants de moins de 6 mois.

N'utilisez pas ce produit si une des pièces est cassée, abîmée ou manquante.

Ne surélevez jamais la nacelle.

Ne laissez pas d'autres enfants jouer sans surveillance à proximité de la nacelle.

N'utilisez pas un matelas autre que celui fourni.

Ce produit est conçu pour les enfants qui ne peuvent pas s'asseoir tout seuls, se retourner et se mettre à quatre pattes. Poids max. de l'enfant : 9 kg.

Soyez conscient du risque encouru si la nacelle se trouve à proximité de flammes nues et autres sources de chaleur intense, comme un chauffage électrique, au gaz, etc.

Veillez toujours à ce que l'arceau de maintien soit attaché lorsque votre enfant est assis dans le siège.

Assurez-vous que tous les dispositifs de verrouillage sont enclenchés avant utilisation.

Utilisez toujours le système de retenue.

Retirez toujours votre enfant du siège avant de soulever le siège pour le retirer du châssis.

Actionnez toujours le frein lorsque vous êtes à l'arrêt.

Vérifiez que les dispositifs de fixation Simplicity sont correctement enclenchés avant utilisation.

Ne retirez pas le siège auto

Simplicity si les adaptateurs sont encore fixés au siège auto.

Votre siège auto Simplicity doit toujours faire face vers l'arrière.

L'enfant doit toujours porter un harnais de sécurité conforme à la norme BS6684. Des anneaux en D sont fournis pour pouvoir attacher un harnais supplémentaire. Ils sont situés sur le harnais existant, à côté du point de fixation du harnais au châssis du siège. Ne suspendez pas des sacs à provisions ou autres objets à la poignée. La poussette risque de se renverser. Les bagages et sacs à provisions supplémentaires doivent être placés dans le panier, et leur poids (5 kg max.) doit être bien réparti. Tenez toujours le siège lorsque vous effectuez des réglages. N'oubliez pas d'actionner le frein.

N'essayez jamais de plier la poussette Pioneer lorsque votre enfant est assis dedans, car il pourrait rester coincé. Si vous rencontrez des difficultés pour plier ou déplier la poussette, ne forcez pas. Vous risqueriez de l'endommager. Lisez attentivement les instructions « Pliage ou dépliage » contenues dans le manuel Pioneer. Ne montez pas des accessoires ou pièces de rechange autres que ceux fournis ou recommandés par Silver Cross, car cela peut être dangereux. Si une personne autre que le propriétaire utilise la poussette (p. ex. les grands-parents ou la gardienne), montrez-lui comment l'utiliser correctement.

Attention : L'enfant doit être tenu à l'écart des pièces mobiles lorsque vous effectuez des réglages.

Ne laissez jamais votre enfant dans la poussette avec la housse pare-pluie complètement déployée pour un usage autre qu'en extérieur.

Toute charge posée sur la poignée, le dossier ou les bords de la poussette risque de compromettre la stabilité de la poussette. Vous êtes responsable de la sécurité de votre enfant.

Sac à langer : Charge max. = 1 kg (vendu

séparément)

Porte-gobelet : Charge max. = 0,5 kg

N'utilisez que les accessoires et pièces de rechange approuvés par Silver Cross.

Nettoyage et entretien

Châssis

Vérifiez toujours que la poussette ne présente pas des traces d'usure. Lubrifiez régulièrement toutes les pièces mobiles. Vérifiez la liberté de mouvement de tous les dispositifs de verrouillage. Frottez les parties métalliques avec un chiffon propre et sec.

Éléments textiles et siège

Pour les instructions d'entretien du tissu, veuillez vous référer au guide d'entretien fourni avec votre poussette. Conservez à l'écart d'une source de chaleur directe et de la lumière intense du soleil. Les couleurs peuvent s'altérer avec le temps. Ne lavez et ne séchez jamais en machine, ne repassez jamais et n'utilisez jamais d'eau de javel.

Ne laissez jamais des accessoires, tels que le pare-soleil ou la housse pare-pluie, à proximité d'une source de chaleur ou de lumière, car les couleurs du tissu peuvent s'altérer et le plastique se déformer (p. ex. sur la plage arrière de la voiture par temps chaud).

Garantie

Tous les produits Silver Cross sont garantis pour une période de 12 mois contre tout défaut de fabrication, lorsque le produit est utilisé conformément au manuel d'instructions.

Lisez attentivement ces instructions avant d'utiliser votre nouvelle poussette Pioneer et conservez-les pour référence.

Norme di sicurezza

Il passeggino Pioneer è un prodotto Silver Cross di alta qualità. È conforme alla norma BS EN: 1888:2012 e con un uso e una manutenzione corretti garantisce un ottimo funzionamento. Se, tuttavia, si riscontrano problemi nell'utilizzo del passeggino, contattare il rivenditore Silver Cross che si adopererà per la risoluzione del problema. La culla da viaggio Pioneer è conforme alla norma BS EN: 1466:2004.

AVVERTENZA:

Mai lasciare il bambino incustodito.

Per evitare infortuni assicurarsi che il bambino sia a debita distanza durante le operazioni di apertura e chiusura del passeggino.

Accertarsi che tutti i dispositivi di bloccaggio siano inseriti prima dell'uso.

Non trasportare più di un bambino nel passeggino.

Il prodotto non è adatto per correre o pattinare.

Accertarsi che il dispositivo di stazionamento sia sempre inserito durante il posizionamento e il sollevamento del bambino.

Controllare che i dispositivi di attacco del corpo del passeggino, del seggiolino, o del sedile dell'auto siano correttamente inseriti prima dell'uso.

Non lasciare che il bambino giochi con il prodotto.

Il prodotto è solo adatto a bambini che non sono ancora in grado di stare seduti da soli.

Il passeggino non è idoneo all'utilizzo per bambini al di sotto dei 6 mesi.

Non utilizzare in caso di parti rotte, strappate o mancanti.

Non usare mai la culla da viaggio su un piedistallo.

Non lasciare che altri bambini giochino incustoditi nelle vicinanze della culla da viaggio.

Non aggiungere un ulteriore materassino se non quello già in dotazione.

Questo prodotto è adatto ai bambini che non sono in grado di stare seduti da soli, di girarsi e di sollevarsi sulle mani e sulle ginocchia. Peso massimo del bambino: 9kg.

Stare attenti ai rischi che possono derivare da fiamme libere e da altre superfici fortemente riscaldate come quelle di stufe elettriche, stufe a gas ecc. che possono trovarsi in prossimità della culla da viaggio

Accertarsi sempre che il bracciolo di protezione sia montato quando il bambino si trova nel passeggino.

Accertarsi che tutti i dispositivi di bloccaggio siano inseriti prima dell'uso.

Utilizzare sempre il sistema di ritenuta.

Fare scendere sempre il bambino prima di tentare di sollevare e rimuovere la seduta.

Azionare sempre il freno di stazionamento quando si è fermi.

Controllare che i dispositivi di attacco della culla Simplicity siano correttamente inseriti prima dell'uso.

Non rimuovere il portabebè Simplicity se gli adattatori sono ancora ad esso collegati.

Il portabebè Simplicity va sempre collocato in senso contrario alla marcia.

Il bambino deve sempre indossare l'imbracatura in conformità alla norma BS6684. Gli anelli a 'D' sono forniti per il fissaggio di una ulteriore imbracatura. Essi sono posizionati sull'imbracatura già presente accanto al punto di fissaggio sulla base della seduta. Non appendere al manico borse della spesa o altri oggetti, che potrebbero provocare il ribaltamento del passeggino. Eventuali sacchetti o borse devono essere sistemati nel cesto per un peso complessivo non superiore ai 5kg, distribuiti in modo uniforme. Tenere sempre la seduta durante le operazioni di regolazione. Accertarsi che il freno sia azionato.

Non tentare mai di ripiegare il passeggino Pioneer quando il bambino è seduto, perché potrebbe rimanere intrappolato. In caso di problemi durante la chiusura o l'apertura del passeggino, non forzare, in quanto il prodotto potrebbe essere danneggiato. Leggere attentamente le indicazioni sull'apertura e la chiusura del passeggino contenute nelle Istruzioni Pioneer. Potrebbe essere pericoloso montare parti di ricambio o accessori diversi da quelli forniti o raccomandati da Silver Cross. Se il passeggino viene utilizzato da soggetti diversi dal proprietario (ad es. nonno, baby sitter), illustrare loro l'uso corretto.

Attenzione: tenere il bambino lontano dalle parti mobili durante le operazioni di regolazione.

Non lasciare mai il bambino nel passeggino con il parapigioggia completamente montato, se non durante il normale impiego all'aperto.

Eventuali carichi presenti sul manico e/o sullo schienale e/o sulle parti laterali compromettono la stabilità del passeggino. La sicurezza del bambino è vostra responsabilità.

Borsa per il cambio: carico massimo = 1 kg (venduta separatamente)

Portabibite: carico massimo = 0,5 kg

Utilizzare solo accessori e parti di ricambio approvate da Silver Cross.

Cura e manutenzione

Telaio

Verificare sempre che sul passeggino non siano presenti segni di usura. Lubrificare regolarmente tutte le parti mobili. Verificare che i dispositivi di bloccaggio funzionino correttamente. Lucidare le parti in metallo con un panno pulito ed asciutto.

Parti in tessuto e seduta

Per le istruzioni per il lavaggio dei tessuti fare riferimento alla guida per la manutenzione in dotazione con il passeggino. Tenere lontano da fonti di calore e dalla luce diretta del sole. Con l'uso quotidiano, il tessuto può scolorire nel corso del tempo. Non lavare in lavatrice, non utilizzare asciugabiancheria, non stirare e non candeggiare.

Non lasciare mai gli accessori, come il parasole o il parapigioggia, esposti al calore o alla luce, ad es. sulla cappelliera dell'auto durante la stagione calda, in quanto i tessuti potrebbero scolorire e/o la plastica potrebbe deformarsi.

Garanzia

Tutti i prodotti Silver Cross sono garantiti per un periodo di 12 mesi contro difetti di fabbricazione, purché il prodotto venga utilizzato correttamente, in conformità al manuale delle istruzioni.

Leggere attentamente le istruzioni prima di utilizzare il nuovo passeggino Pioneer e conservarle per future consultazioni.

Notas de seguridad

La silla Pioneer es un producto de gran calidad de Silver Cross. Cumple la normativa BS EN: 1888:2012 y, si la utiliza adecuadamente y realiza un buen mantenimiento, le proporcionará un servicio excelente. No obstante, si tiene algún problema con su silla, póngase en contacto con el punto de venta de Silver Cross donde la adquirió para que se encargue de tomar las debidas medidas. El capazo Pioneer cumple la normativa BS EN: 1466:2004.

ADVERTENCIA:

No deje al niño sin vigilancia en ningún momento.

Para evitar lesiones, asegúrese de que el niño se mantenga alejado al plegar y desplegar este producto.

Asegúrese de que todos los dispositivos de inmovilización estén accionados antes de su uso.

No transporte a más de un niño en esta silla.

Este producto no es apto para correr ni para patinar.

Asegúrese de que los frenos estén accionados al colocar y retirar al niño.

Compruebe que los dispositivos de sujeción (ya sean los del chasis, el asiento o la silla del coche) estén accionados correctamente antes de su uso.

No deje que el niño juegue con este producto.

Este producto solo es apto para los niños que no puedan sentarse sin ayuda.

Este asiento no es apto para niños menores de 6 meses.

No lo utilice si alguna de sus piezas está rota o desgastada; , tampoco si falta alguna pieza.

Nunca utilice el capazo sobre un soporte/base.

No deje que otros niños jueguen cerca del capazo sin vigilancia.

No añada un colchón diferente al suministrado.

Este producto es apto para niños que no sepan sentarse, darse la vuelta ni ponerse a gatas por sí solos. Peso máx. del niño: 9 kg.

Sea consciente del riesgo que presentan las chimeneas y otras superficies que emitan altas temperaturas, como las chimeneas eléctricas, estufas de gas, etc. que puedan encontrarse cerca del capazo.

Asegúrese de que la barra protectora esté siempre sujeta cuando el niño esté en el asiento.

Asegúrese de que todos los dispositivos de inmovilización estén accionados antes de su uso.

Utilice siempre el sistema de retención suministrado.

Retire siempre al niño del asiento antes de intentar levantar y extraer el asiento.

Accione el freno siempre que se pare.

Compruebe que los dispositivos de sujeción Simplicity estén colocados correctamente antes de su uso.

No extraiga el portabebés Simplicity con los adaptadores aún conectados al Simplicity.

El portabebés Simplicity siempre debe ir en el sentido contrario al de la marcha.

El niño debe llevar siempre abrochado un arnés de seguridad que cumpla la normativa BS6684. Se proporcionan anillas en forma de "D" para sujetar otro arnés. Estas están situadas en el arnés existente, cerca del lugar donde está sujeto al armazón del asiento. No cuelgue las bolsas de la compra ni otros objetos del manillar; es posible que la silla vuelque. El equipaje o las compras adicionales se deben transportar únicamente en la cesta, no deben superar 5 kg de peso y deben distribuirse uniformemente. Sujete siempre el asiento cuando haga ajustes. Asegúrese de que el freno esté accionado.

Nunca intente plegar su Pioneer cuando el niño esté sentado, ya que es posible que quede atrapado. Si le resulta difícil plegar y desplegar la silla, no la fuerce, ya que la dañará. Lea detenidamente la sección "Cómo plegar y desplegar" de las instrucciones de Pioneer. Puede resultar peligroso instalar piezas de recambio o accesorios que no sean suministrados o recomendados por Silver Cross. Si alguien que no sea su propietario va a utilizar la sillita (por ejemplo, un abuelo, una niñera), enséñele cómo hacerlo correctamente.

Precaución: El niño debe estar lejos de las partes móviles mientras se hagan ajustes.

No deje en ningún momento al niño en la silla con la burbuja de lluvia totalmente colocada, excepto durante su uso normal en el exterior.

Toda carga que sujete al manillar, el respaldo o los laterales de este vehículo (ya sea a la vez o por separado) afectará a la estabilidad del mismo. Usted es responsable de la seguridad del bebé.

Bolso cambiador: Carga máxima = 1 kg (se vende por separado)

Portavasos: Carga máxima = 0,5 kg

Solo se deben utilizar accesorios y piezas de recambio autorizadas por Silver Cross.

Cuidado y mantenimiento

Chasis

Compruebe siempre si la silla presenta indicios de desgaste. Lubrique periódicamente todas las partes móviles. Compruebe que haya total libertad de movimiento en todos los dispositivos de inmovilización. Abrillante el metal con un paño limpio y seco.

Componentes de tela y asiento

Consulte las instrucciones de lavado en la guía de cuidado incluida con su silla. Manténgase lejos de calor directo y de rayos de sol fuertes. Es posible que pierda el color en cierta medida con el uso diario. No los lave nunca a máquina, no los seque en la secadora, no los planche ni utilice lejía.

Nunca deje accesorios como el protector solar o la burbuja de lluvia en un lugar en el que el sol o la luz puedan decolorar los tejidos o deformar el plástico, p. ej. en la bandeja del maletero del coche en un día caluroso.

Garantía

Todos los productos de Silver Cross incluyen una garantía de 12 meses contra defectos de fabricación, siempre que el producto se utilice correctamente de acuerdo con el manual de instrucciones.

Lea detenidamente estas instrucciones antes de utilizar su nueva silla Pioneer y consérvelas para consultarlas en el futuro.

安全注意事项

Pioneer 折叠式婴儿推车是 Silver Cross 生产的一款优质产品。本品符合 BS EN 1888:2012 标准，如果使用及维护得当可经久耐用。如果您的折叠式婴儿推车出现问题，请联系 Silver Cross 零售商，零售商将采取适当的措施。Pioneer 睡篮符合 BS EN 1466:2004 标准。

警告：

婴儿乘坐时，必须有人看护。

为了避免伤到婴儿，在折起或打开本产品时请不要让孩子靠近。

使用推车前确保所有锁定装置均处于锁定状态。

折叠式婴儿推车仅能容纳一个婴儿。

本产品不适合奔跑或滑行。

在将孩子抱出或放入婴儿车之前要确保推车的驻停装置都已锁定。

使用前检查婴儿车的车身、座椅或汽车座位连接装置是否连接牢固。

不可让婴儿摆弄本产品。

本产品仅适合不能独自坐起的婴儿。

本座椅不适合小于6个月的婴儿。

如有部件损坏、破损或丢失，请不要使用本产品。

请不要在支架上使用睡篮。

不要让其他无人看护的婴儿在睡篮旁边玩耍。

请勿在现有婴儿床垫基础上再放置床垫。

本产品适合不能独自坐起、翻身、用手或膝盖撑起身体的婴儿。婴儿最高限重：9kg

在婴儿睡篮周围要小心防范明火、其他包括电暖气、炉火在内的高热表面可能带来的安全隐患。

将宝宝抱进座椅内之后，保险装置一定要连接妥当。

使用前确保所有锁定装置均处于锁定状态。

要养成使用完全防护装置的习惯。

在尝试提起或挪开座椅前一定要先把婴儿抱离。

在您站立不动的时候要养成使用驻停刹车装置的习惯。

使用前检查 Simplicity 产品连接装置是否连接牢固。

在转换套件还与 Simplicity 婴儿汽车安全座椅相连时不要移动安全座椅。

Simplicity 婴儿汽车安全座椅必须面朝车的后方放置。

婴儿应始终系好符合 BS6684 标准的安全带。同时可以使用配套的半圆环，用于安装加固安全带。您可以在连接座椅框架的安全带处找到这些半圆环。请勿将购物袋或其他物品挂在手柄上。这可能会使折叠式婴儿车翘起。多余的物品或行李只能放在购物篮中，重量不得超过5kg，且需均匀摆放。在进行调节时，始终握住座椅。确保使用刹车装置。

当孩子坐在 Pioneer 婴儿车里面时，请勿折叠本产品，因为这可能会夹到孩子。如果您在折起或打开折叠式婴儿车时遇到困难，请勿强行操作。这会损坏婴儿车。仔细阅读 Pioneer 婴儿车使用说明书中的“折起或打开”说明。除 Silver Cross 提供或推荐的产品外，安装其他配件或备件可能会有安全隐患。如果除您之外的其他人（比如孩子的爷爷奶奶，保姆等）要使用婴儿车，请向他们演示正确的操作方法。

注意：在进行调节时，孩子应远离运转中的零件。

请勿将您的孩子留在整体安装防雨罩的折叠式婴儿车中，正常户外使用除外。

婴儿车手柄和（或）座椅靠背和（或）婴儿车两侧如果有任何负重均会

影响婴儿车的稳定性。保护婴儿的安全是您的责任。

整理包：最大容量 = 1kg(选购配件)

杯架：最大承重量 = 0.5kg

只可使用 Silver Cross 提供或推荐的配件或备件。

保养与维修

底盘

要经常检查折叠式婴儿车是否有磨损迹象。定期润滑所有运转零件。检查所有锁定装置的运动灵活性。用干净、干爽的抹布擦拭金属部件。

织物和座椅

织物洗涤护理说明细节详见婴儿车附带的洗涤护理标签。请勿将产品置于直接热源或日照强烈的地方。随着长期使用，产品可能出现某种程度上的褪色。请勿机洗、烘干、熨烫或漂白。

请勿将配件如遮阳罩或防雨罩放在高热、强光下，因为可能会导致织物褪色或塑料变形，例如不要在天气炎热时放在汽车的行李架上。

保修

在依据说明书正确使用产品的情况下，Silver Cross 承诺产品质保期12个月。

请在使用新的 Pioneer 折叠式婴儿车之前仔细阅读这些说明并妥善保存以供未来参考。

Комментарии по безопасности
Детская коляска Pioneer — это высококачественное изделие компании Silver Cross. Коляска соответствует требованиям стандартов BS EN: 1888:2012 и при надлежащем использовании и обслуживании будет работать безотказно. Если, тем не менее, возникнут какие-либо проблемы, обращайтесь за помощью в магазин Silver Cross по месту приобретения коляски. Коляска соответствует требованиям стандартов BS EN: 1466:2004.

ВНИМАНИЕ!

Никогда не оставляйте ребенка без присмотра.

Во избежание травматизма убедитесь, что при складывании и раскладывании коляски она находится вне пределов досягаемости вашего ребенка.

Прежде чем использовать коляску убедитесь, что все фиксаторы задействованы.

Коляска предназначена только для одного ребенка.

Данное изделие не предназначено для бега или катания на роликах.

Включите стояночный тормоз коляски перед тем, как усаживать или высаживать ребенка из коляски.

Перед использованием коляски убедитесь, что крепления рамы коляски, сиденья или автокресла правильно зафиксированы.

Не давайте ребенку использовать изделие в качестве игрушки.

Это изделие предназначено только для детей, которые не могут сидеть без посторонней помощи.

Данное сиденье не предназначено для детей до 6 месяцев.

Не используйте изделие, если какая-либо часть сломана, повреждена или отсутствует.

Никогда не используйте люльку на подставке.

Не давайте другим детям играть рядом с люлькой без присмотра.

Используйте матрас только из комплекта поставки.

Данное изделие предназначено для ребенка, который не может сидеть самостоятельно, переворачиваться и не может встать на четвереньки. Максимальный вес ребенка: 9 кг. Учитывайте риск открытого пламени и других поверхностей с высокой температурой, таких как электрический камин, газовое пламя и т. д., в непосредственной близости от коляски. Всегда проверяйте, установлен ли поручень, когда ребенок сидит в сиденье.

Перед использованием убедитесь, что задействованы все фиксаторы.

Всегда используйте систему ремней перед тем как поднимать и снимать сиденье.

Всегда включайте стояночный тормоз во время остановки.

Перед использованием убедитесь, что навесные устройства Simplicity правильно зафиксированы.

Не снимайте детское автокресло Simplicity, если переходники прикреплены к подставке Simplicity.

Детское автокресло Simplicity следует всегда устанавливать спинкой вперед.

Ребенок должен быть обязательно пристегнут ремнями безопасности, соответствующими стандарту BS6684. Для крепления дополнительных ремней в конструкции коляски предусмотрены D-образные кольца. Они расположены на стандартных ремнях безопасности рядом с точками их крепления к раме сиденья. Не вешайте сумки и другие предметы на ручку коляски. От их веса коляска может опрокинуться. Предметы и покупки можно перевозить только в специальной корзине, а их общий вес не должен превышать 1 кг

и должен быть распределен равномерно. Регулируя положение деталей коляски, всегда держите ее за сиденье. Убедитесь, что тормоз включен.

Ни в коем случае не пытайтесь сложить коляску Pioneer с находящимся в ней ребенком: коляска может его защемить. Складывая и раскладывая коляску, не прикладывайте излишних усилий. Вы можете повредить коляску. Внимательно прочтите инструкции Pioneer по складыванию и раскладыванию коляски. Использование аксессуаров и запасных деталей, не поставляемых и не рекомендованных компанией Silver Cross, может быть опасным. Если коляску использует другой человек (например, бабушка, дедушка или няня), обязательно объясните этому человеку, как правильно ее использовать.

Внимание! Регулируя изделие, следите за тем, чтобы ребенок не приближался к его подвижным деталям.

Никогда не оставляйте ребенка в коляске с полностью установленным дождевиком кроме случаев обычного использования коляски на улице.

Вещи, висящие на ручках и/или спинке и/или боках коляски влияют на ее устойчивость. Вы несете ответственность за безопасность ребенка.

Сумка со сменой белья: максимальная нагрузка = 1 кг (продается отдельно)

Подстаканник: максимальная нагрузка = 0,5 кг

Используйте только принадлежности и запасные части, одобренные компанией Silver Cross.

Уход и обслуживание

Рама

Всегда проверяйте коляску на предмет износа. Регулярно смазывайте все движущиеся части. Проверяйте, свободно ли работают все фиксаторы. Металлические части протирайте сухой, чистой тканью.

Детали из ткани и сиденье

Указания по уходу за тканью имеются в руководстве по уходу, прилагаемом к изделию. Не подвергайте детали коляски воздействию источников тепла и прямых солнечных лучей. Со временем ткань может немного выцвести в процессе повседневного использования. Запрещено стирать и сушить детали коляски в стиральной машине, гладить и отбеливать их.

Никогда не оставляйте такие принадлежности как козырек от солнца или дождевик там, где тепло и солнечный свет могут обесцветить ткань или покоробить пластик, например, на багажной полке автомобиля в жаркую погоду.

Гарантия

На всю продукцию Silver Cross действует гарантия сроком 12 месяцев, распространяющаяся на случаи производственного брака, при условии использования изделия в соответствии с инструкциями.

Перед использованием новой коляски Pioneer внимательно прочтите настоящую инструкцию и сохраните ее для использования в будущем.

Silver Cross®

THE BEST START IN LIFE

Silver Cross (UK) Ltd, Micklethorn, Broughton, Skipton, North Yorkshire, BD23 3JA

silvercrossbaby.com

SXPioneerUK08 13