













Viron e-Quilibrium Salt Chlorinator

INSTALLATION AND OPERATING INSTRUCTIONS



-  The appliance is not intended for use by young children or infirm persons without supervision. Please ensure that young children are supervised to ensure that they do not play with the appliance.
-  Controller must be installed according to AS 3000 wiring rules.
-  If the supply cord is damaged it must be replaced by AstralPool or its service agent or a similar qualified person in order to avoid a hazard.
-  This product is NOT suitable for use on Spa Pools UNLESS the OPTIONAL pH sensor has been purchased and installed.
-  When used on Spa Pool applications, AstralPool strongly recommend the purchase and installation of a chlorine sensor in addition to the pH sensor.
-  This product is NOT suitable for use on Indoor swimming pools UNLESS the pH and Chlorine sensors have been purchased and installed.
-  The Viron e-Quilibrium can only be purchased through a professional pool business and MUST be installed by that dealer.
-  Dose pool with a small amount of chlorine before starting the eQ. If no chlorine is sensed the eQ may go to fail safe mode and not start up. Some Chlorine should be present before starting the unit.
-  Take extreme care when handling the pH adjuster which is either sulphuric acid or hydrochloric acid. Wear gloves, eye protection and breathing protection.
-  Before installing probes, balance pool water. Total Alkalinity (TA) must be 80 to 120 ppm, Calcium Hardness should be 180 to 250 ppm, and pH must be between 7.2 and 7.6.
-  Cyanuric Acid, sometimes referred to as stabiliser or sunscreen will suppress the Chlorine (ORP) reading when the Chlorine sensor is connected. Refer to section on setting chlorine levels if Cyanuric Acid is present in your pool.

Contents

Introduction.....	4
1.1 Components with Viron e-Equilibrium Basic Chlorinator System	4
2.0 Installation Viron e-Equilibrium chlorinator	5
2.3 Connecting the PVC Acid Tube	6
3.0 Starting your Chlorinator	8
3.1 Set up	9
3.2 Setting Timers	9
3.3 Timer Recommendations:	9
4.0 Operating Functions Accessed through Maintenance Program	10
5.0 Calibration of pH Sensor/Probe:.....	11
6.0 OPERATION	11
6.1 Adjusting Chlorine Output.....	12
6.2 Adjusting pH Set Point	12
6.3 Installation of the pH sensor	13
6.4 Installation of the Chlorine Sensor	14
7.0 General Operation/Pool Chemistry	16
7.1 Setting the Right Chlorine Output and Filtration Time	16
Summer	16
Winter.....	16
7.2 Checking Chlorine Level.....	16
7.3 Stabiliser	16
7.4 pH Level	16
7.5 Total Alkalinity	16
7.6 Salt Level.....	16
7.7 ACID Handling.....	16
8.3 Swimming Pool Applications and the use of Cyanuric Acid.....	17
9.0 Ai Mode – complete automatic control of your Pool & Spa	17
9.3 Ai Mode set up.....	17
9.4 Viron eVo Pump speed selection:.....	17
9.6 Effects of Ai Mode	18
9.7 Extended Operating hours and high speed pump operation	19
11.0 Fault Indication and trouble shooting	22
11.1 Regular Maintenance	23
12.0 WARRANTY	23

Introduction

Congratulations on your purchase of the Viron series Salt Chlorinator. The correct pH balance of your pool water significantly increases the effectiveness of the chlorine in the water and if not maintained at the correct level, can cause harm to the interior finish of your swimming pool or spa and reduce the disinfection time of the chlorine.

The purpose of the Viron eQuilibrium series chlorinators is to significantly reduce the level of daily and weekly maintenance required to keep your pool and spa sparkling clean and healthy to swim in.

These installation and operating instructions will guide you through installation, operation and maintenance of your new chlorinator. Regular maintenance will ensure many years of trouble free operation.

1.1 Components with Viron e-Quilibrium Basic Chlorinator System

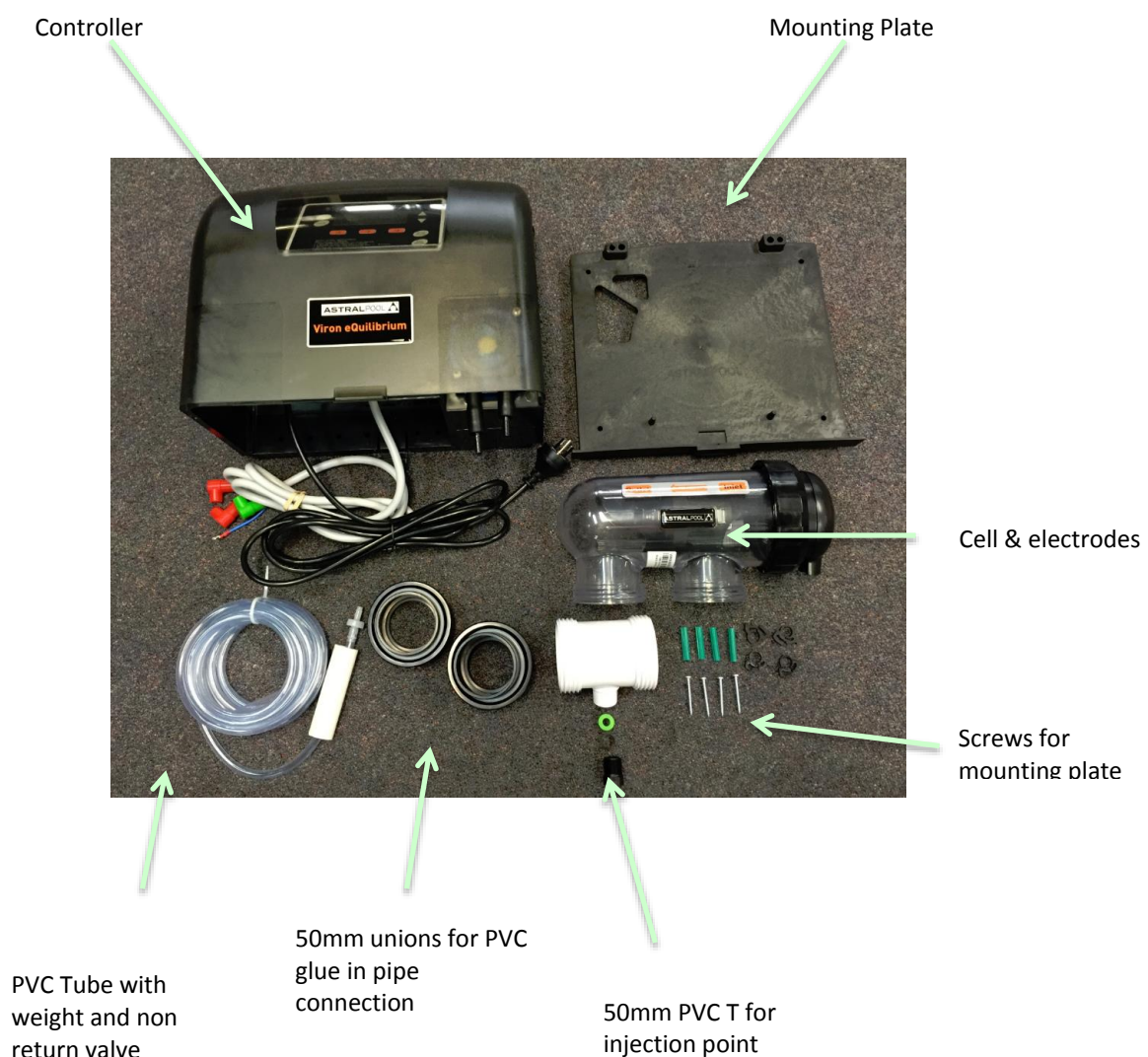

2.0 Installation Viron e-Quilibrium chlorinator

The Viron e-Quilibrium Chlorinator incorporates a controller with inbuilt acid pump, an electrode cell for converting minerals or salts into chlorine, a mounting plate for the controller and tubes, weights and injection points for the acid which controls your pool water pH. The intelligent software allows you to select and change your acid dosing ratio and intelligently adjusts the dose rate to match the output of the electrode. (The higher the output, the faster the pH will change and the more the controller will dose acid to compensate). **However, you MUST test your pH every day for the first week and adjust your acid dose rate on the controller to achieve the correct pH level.**

2.1 pH levels:

Generally you should aim to have your pH at 7.4 to 7.8. The actual pH you choose for your pool will depend on the water quality in your area, the interior finish of your pool and the type of pool you have.

2.2 Mounting the Controller:

Choose a location that is preferably out of direct sunlight, near the filter system. The controller should be located 1 metre above ground level to prevent rain splash back or sprinkler system damage to the underside of the controller. The controller must be mounted on a vertical surface/wall. If mounted on a post, a flat sheet 20mm larger than the controller housing must be used.

- Mount the wall bracket using the screws provided on a secure wall.
- Glue sensing chamber for probe into plumbing line after filter and gas heater (if installed) but prior to chlorinator cell. **Sensor Chamber must be plumbed to ensure probe is horizontal to water flow.**
- Glue Chlorinator cell into line as per drawing below after filter, heater, solar (if installed) and after sensor T piece.
- Plug the pH sensor into the underside of the controller in the location marked "pH".
- Plug filter pump 3 pin plug into underside of Controller.
- Connect 4 wire cell cable ensuring matching colours.
- Remove cap from pH sensor and screw firmly into sensor chamber installed in the plumbing. Do Not Over tighten.
- The cell **must** be installed with the barrel unions underneath and the cell should be horizontal. Both 40mm and 50mm fittings have been provided. Make sure that the 'o'rings are correctly fitted and the unions are done up tightly. Flow direction through the cell is critical – refer to label on housing.
- Hang Controller on wall bracket and plug power supply lead into 3 pin 10 amp outlet.



2.3 Connecting the PVC Acid Tube

PLACEMENT OF CHEMICALS, EQ CONNECTIONS.

Placement of Chemicals

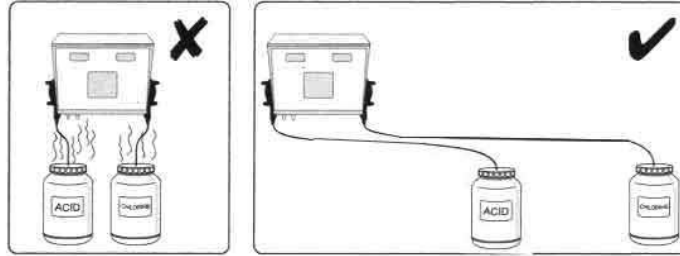

*****Chemicals MUST be stored apart in accordance with Relevant Standards and Dangerous Goods Codes. Consult your authorized builder or pool shop technician for advice. Chemicals must be at least 1 metre horizontally from control unit in a well ventilated area to avoid corrosive damage.**

Placement of EQ Unit

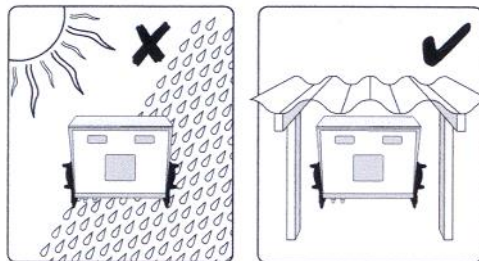

Connection of Lines

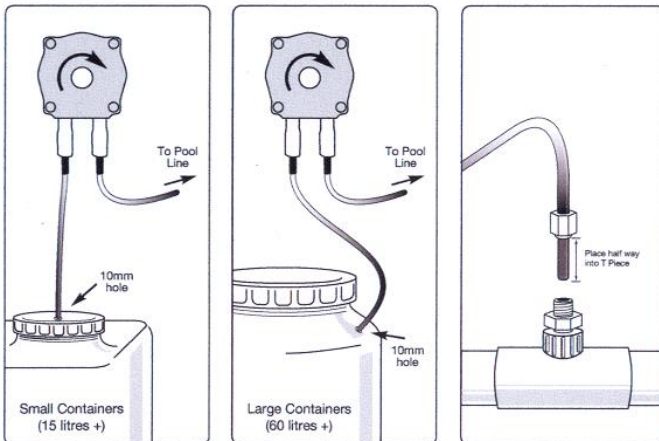

Before installing the unit in position on the wall or post, the length of the PVC tubing provided should be measured and taken into consideration. Ensure the controller and cell are close enough for the power supply lead to reach the cell and sufficient PVC tube exists to connect acid container and cell. To avoid loss of water from the system, close all stop valves before cutting any lines.

Thread the clear PVC tube through a hole in the cap or shoulder of the chemical container and fit the non-return or check valve and the weight. Ensure that the non-return valve is fitted correctly. Drop the weight, with the non-return valve into the bottom of the container.

The clear PVC tube should snugly fit in the hole in the cap or shoulder of the chemical container. A small 2mm breather hole should be made in the cap or shoulder to allow air to fill the void created by the acid pumped into the pool.

Connect the other end of the PVC tube to the inlet of the acid pump on the front of the controller.

Connect the remaining hose to the outlet of the acid pump on the underside of the controller. The remaining end of the PVC hose should be pushed through the cable gland in the 50mm PVC mixing cell fitting so that it passes through the cable gland by 25mm to 30mm.

Locate the injection chamber (diagram below) in a horizontal position after the Chlorinator cell on the return to pool side.

TIP: Soaking the ends of the PVC tubing in hot water or gently heating with a lighter makes it easier to push onto the barb. When installing acid container in a filter enclosure, which has no ventilation, it is recommended that the hole in the cap of the container is cut or drilled to fit tightly around the tubing, so that fumes from the acid will not corrode the equipment. It will be necessary to drill a second hole in the cap fitted tightly with a length of tubing which should then be vented outside the filter enclosure. This procedure is recommended only where the filter enclosure has no ventilation and is to protect the equipment.



- NEVER MIX CHEMICALS

- CHEMICALS MUST BE STORED IN ACCORDANCE WITH RELEVANT STANDARDS AND DANGEROUS GOODS CODES. CONSULT YOUR AUTHORISED BUILDER OR POOL SHOP TECHNICIAN FOR ADVICE.
- WHEN HANDLING ACID, SAFETY GLOVES AND GOGGLES SHOULD ALWAYS BE USED
- FOR BEST RESULTS, USE OF NEAT ACID IS RECOMMENDED

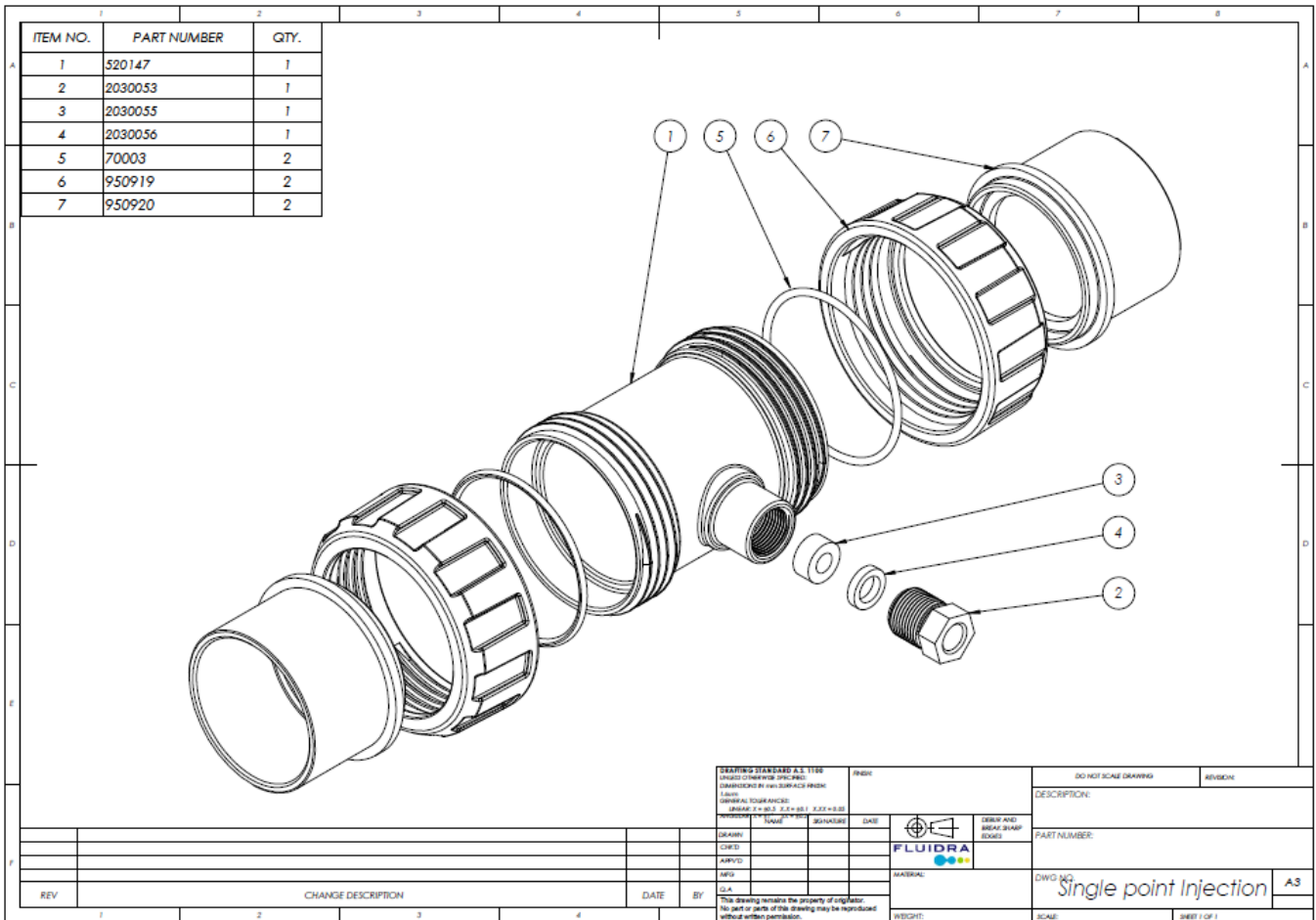

3.0 Starting your Chlorinator

Your Chlorinator Controller operation can be divided into 4 areas;

- a. MAINTENANCE – selects specialised functions of your chlorinator and initial set up of Chlorinator to suit your pool and spa.
- b. SET – selects changes in Chlorine production and pH of your pool and spa water.
- c. CLOCK & TIMER buttons – sets current time and filtration, chlorine production and pH monitoring and adjustment times from Monday to Friday and weekends.
- d. Pool and Spa Mode – Allows selection of pool mode where controller will produce chlorine suitable for Pool and Spa Mode, where chlorine production and acid dosing is reduced to suit a smaller volume of water in the Spa.

3.1 Set up

- a. Press "**Pool Mode**" button until **Manually Off** appears and then Press "**Clock**" Button
- b. Select "**Day**" and use buttons adjacent to LCD screen to set the current day, hour and minute. The clock is a 24 hour clock.

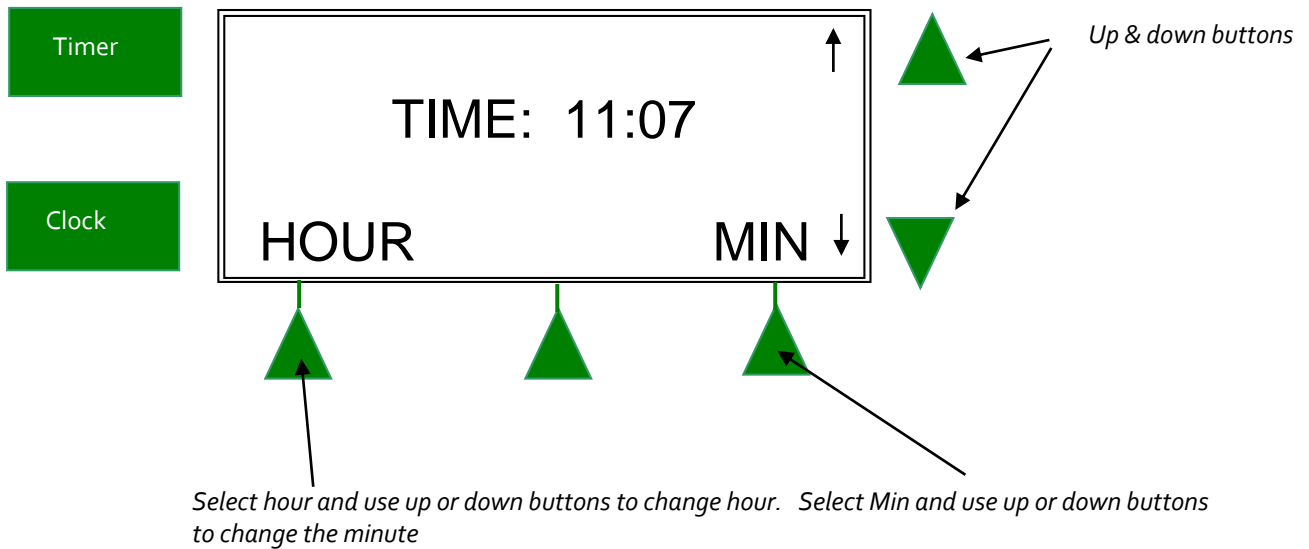

3.2 Setting Timers

Your Viron chlorinator has 4 timers per day enabling you to set different periods in which your filtration pump, pH control and chlorine production will operate. Timers are set by entering a start time, and a **RUN** time for how long you want to operate. To set timers, do the following:

- a. Press the **TIMER** button.
- b. Press **HOUR** button to set the hour for the timer selected and use the Up/Down arrows to change the time.
- c. Press **MIN** button to select the minutes for the timer selected and use the Up/Down arrows to change the time. Press the **NEXT** button to select the **RUN** time or another time and set as required. Note: The RUN time represents the number of hours you want the unit to operate for.
- d. When finished, press the **NEXT** button a number of times to scroll through the other times until you return to normal display. This saves your new settings.
- e. Select **Auto Sanitising** by pressing the **POOL** mode button. The **POOL** mode button has three settings, manually **ON** which turns on system indefinitely, manually **OFF** which turns system off indefinitely, and **AUTO** mode which sets the controller on timer clock mode. In **AUTO** mode the LCD screen will display the date and pool sanitiser message.
- f. 3.3 Timer Recommendations:

AstralPool recommend that you use two timers, one for the morning and one for the evening and typically for periods of 2-5 hours for each. Generally, you should operate your pool for 8 hours a day in total to achieve sufficient chlorine production and circulate the pool water including skimming which will reduce debris settling in the pool and ongoing maintenance. Your Viron Series chlorinator is most effective if running in the early morning or evening when it is cooler (strong sunlight consumes more chlorine). As a default, the control is set to come on at 08:00 hours and 16:00 hours both for periods of 4 hours.



4.0 Operating Functions Accessed through Maintenance Program

Press **MAINT**

To backwash your filter press **BWASH** and then the up or down arrows to select the backwash time. You can press **ABORT** at any time to finish the backwash. To rinse the filter, you can select **BWASH** again and then select the time. Using this feature will ensure your sand filter is backwashed for the correct time. Note: Ensure pump is off when changing the position of the backwash valve on your filter. As a guide, sand filters should be backwashed for 2 to 3 minutes, and then rinsed for 1 minute.

Press **MAINT**

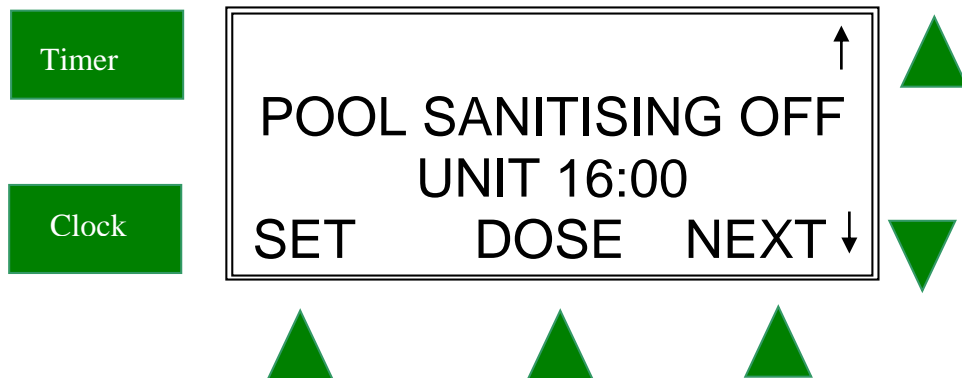

- i. Dose will allow you to override the time clock and allow the following:
 - a. Sanitise until the first timer tomorrow morning. This allows for additional circulation of the swimming pool water after treatment or cleaning. Can be used to provide a shock dose of chlorine production.
 - b. Manually prime Acid Pump. This allows for the clear PVC tube to be filled with Acid on initial start up or after changing or refilling the Acid Container. The priming period is for 300 seconds but can be stopped at any time. Should the tube not be completely filled with Acid after 300 seconds repeat the process.
 - c. Manually Dose Acid. Selecting this function allows you to manually dose acid for a predetermined time. Should your pool professional recommend the addition of Acid to your pool, select this function and press the up (or down) arrow to select the quantity of acid in litres you wish to dose. Press **ACCEPT**. The controller will then ask you what mode you wish the unit to revert to at the completion of Acid dosing, "AUTO", "ON" or "OFF". In normal circumstances you will select "AUTO" which puts the unit back into time clock operation.
- ii. **INSTALL** allows the unit to be set up for your pool or spa. This should only be selected in the initial start up of your Chlorinator. Select **INSTALL** and the following will occur:
 - a. **TIMER ENABLED** – this function will turn your timer on or off. If the chlorinator is not connected to an external timer clock or Genus Remote Control system Press **ACCEPT**. If an external time clock is used to operate the chlorinator and filter pump then change to disabled.
 - b. **FAST COMMS** – set standard to YES, this option will only need to be changed if using an older version Hurlcon/AstralPool controller (no touchscreen)
 - c. **VARIABLE SPEED PUMP** – select YES if you have an AstralPool 3 speed pump. This will allow you to program the speed of the pump as part of the timer setting in the chlorinator.
 - d. **FLUSH AFTER TIMER** – select YES and your pump will come on momentarily after the timers have finished to flush any residual chemicals from the injection chamber.
 - e. **PUMP FLOW CHECK** – If active this function will monitor the flow sensor inside the chlorinator cell. If the presence of water flow is not detected for over 5 minutes, power to the pump outlet will be shut down to prevent your pump running dry.
 - f. **ENABLE LIGHT** – Your e-Q series chlorinator has an output to operate a single AstralPool ARC LED light.
 - g. **CELL REVERSAL PERIOD** – Standard setting is 4 hours. This should not be changed without consulting with your local AstralPool dealer or service department.
 - h. **REVERSE CELL?** – This feature can be used to perform a manual reverse of your chlorinator cell – designed for use by your pool technician only.
 - i. **SET POOL WATER VOLUME**, select **YES** and then use up or down arrows to change the volume of your pool. Press **ACCEPT**
 - j. **SET SPA WATER VOLUME**, select **YES** if your have a SPA attached to your pool and then set volume. Press **ACCEPT**
 - k. **RESET SYSTEM?** – **SELECT NO** (This option will revert your chlorinator back to factory settings. It should only be used if your e-Q series chlorinator enters an error that cannot be cleared).

Cycle through **POOL MODE** button to select **Auto**, **Manually ON** or **Manually OFF**.

AUTO will allow the unit to operate your filter pump, chlorine production and pH adjustment on the timer periods you have selected. If you have not changed the timer periods, the default timer turns the filter pump and unit on at 08:00 hours for a period of 4 hours and then again at 16:00 hours for a further period of 4 hours. This is the default setting from the factory.

5.0 Calibration of pH Sensor/Probe:

From time to time, the pH sensor will require cleaning and calibration. Typically, calibration should take place one every 6 to 12 months.

To Calibrate, Press **MAINT** and next until **CAL** appears on the LCD. Select **CAL** to commence the process.

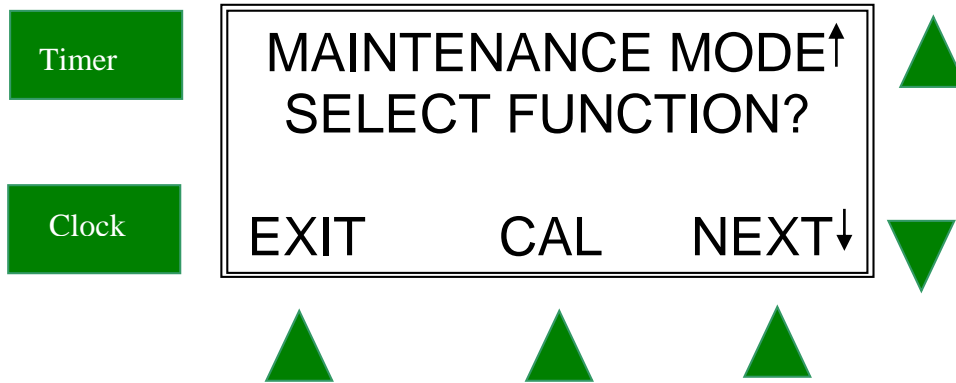

CAL

The pH probes/sensor has been factory calibrated. However it is a good practice to check the adjustment for the probe periodically (every 6 months or earlier if required). The probe should be cleaned first (refer under Maintenance page for cleaning) and allowed to settle down for about 4-5 minutes before adjusting/calibrating. The most accurate way to calibrate is to put the probe in a calibration solution. Calibration solution is available via AstralPool as a spare part.

When the controller is in Manual Off mode, remove the pH probe from the pipeline (shut off the filter pump and close any isolation valves to avoid water spill), clean the probe (see under Maintenance) and place it in a 7.5 pH Easy Cal Solution (available from AstralPool). Press **MAINT** and then next until **CAL** is displayed. The unit will ask **CHANGE PH CALIBRATION**, select **YES**. Select **NO** to Filter Pump on?

The display will indicate that the system is measuring pH. When the pH is displayed, press the **UP** or **DOWN** buttons to get the display to indicate the same value as the buffer (7.5) and then press **ACCEPT**

6.0 OPERATION

During operation, adjustments are made by the **SET** button.



6.1 Adjusting Chlorine Output

Press the **SET** button to change the chlorine output and the pH of your Pool

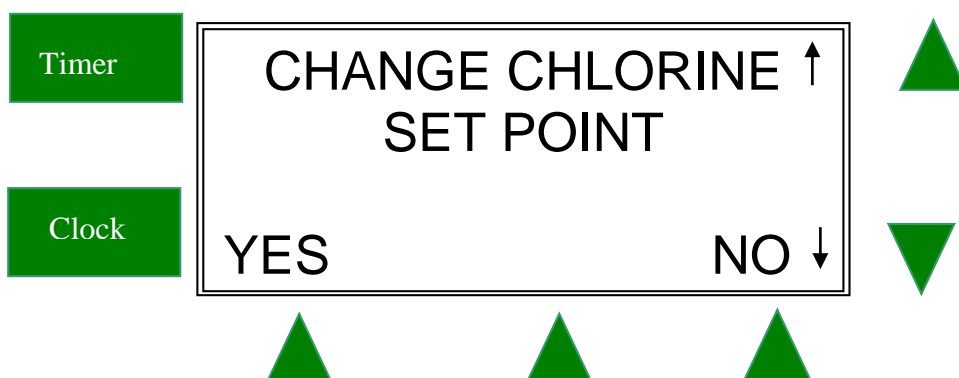

Press YES to change the output

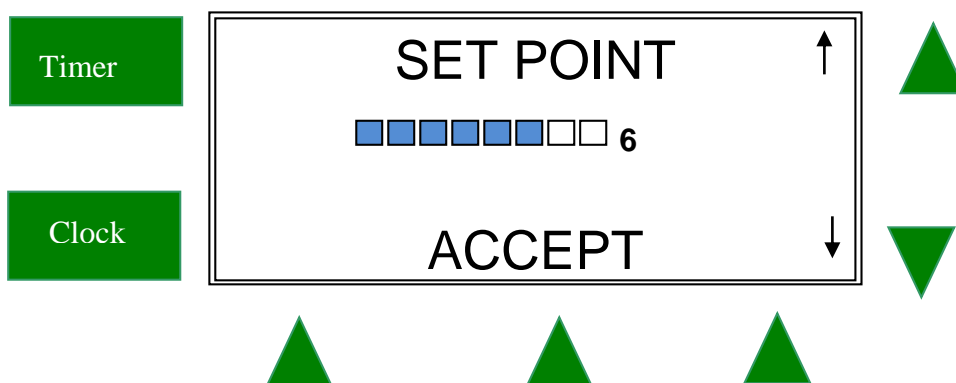

Use the up and down buttons to change the Set Point between 0 and 8. 0 chlorine output should only be used when there is no salt in the water. In summer, the chlorine should be set between 6 and 8 and you should regularly check your chlorine level in your swimming pool to determine if the output should be increased or decreased. Rely on your pool professional for advice on the recommended chlorine level in your pool.

As a guide the free chlorine level should be between 1.0 ppm and 3.0 ppm.

6.2 Adjusting pH Set Point

Continue through the **SET** menu to change the pH balance of your pool.

As a guide the pH in your pool should be set between 7.4 and 7.8. This will be determined by the type of pool you have, (Concrete, Fibreglass, Vinyl Liner) and you should rely on your pool builder or pool professional to recommend the correct pH Set Point. Use the up and down arrows to set your pH value.

6.3 Your basic Viron e-Quilibrium is supplied without any pH or Chlorine sensors. (These sensors must be ordered separately). In this format, you can determine the dosing rate of the acid by selecting 1 to 10 in the pH set screen. The unit will also intelligently adjust the dosing level according to the chlorine production (the higher the chlorine production, the faster the pH change and the more acid required). However, you **MUST** check your pH balance in the pool each day for the first week of operation and adjust the pH setting on your chlorinator until it settles at the desired pH level. Once the desired pH level is achieved, continue to manually test your pH every week and adjust the pH setting as required.

Installation of the acid dosing tube – to be installed after the chlorinator cell on return to the pool

Once the pH value is set your LCD screen will return to the operating information screen which will cycle through the current status of the chlorinator and the chlorine output setting (between 0 and 8).

6.3 Installation of the pH sensor

The optional pH sensor eliminates the need to regularly test your pH balance of your pool and spa. **The sensor will require checking and recalibrating approximately once every 6 months.**

When installed and connected the Viron e-Qilibrium will automatically detect the pH sensor and the factory pH setpoint is 7.6. You can adjust your ideal pH setting in the "settings" menu.

The pH sensor is supplied with a sensor chamber that is connected into 50mm PVC pipe work using 50mm union tails and lock nuts. Locate the sensor chamber (diagram below) in a horizontal position with the "Locate to Top" embossing in the 12 o'clock position BEFORE the Chlorinator, where possible after the filter but before chlorinator's Cell. Glue in 50mm PVC pipe into union tails. Alternatively, locate the sensor chamber in a vertical position after the filter and before the chlorinator cell. Remove rubber boot from pH sensor and screw into the sensor chamber port as shown. The remaining ports in the sensor chamber are blanked off using the caps and gaskets supplied as per the assembly diagram below.

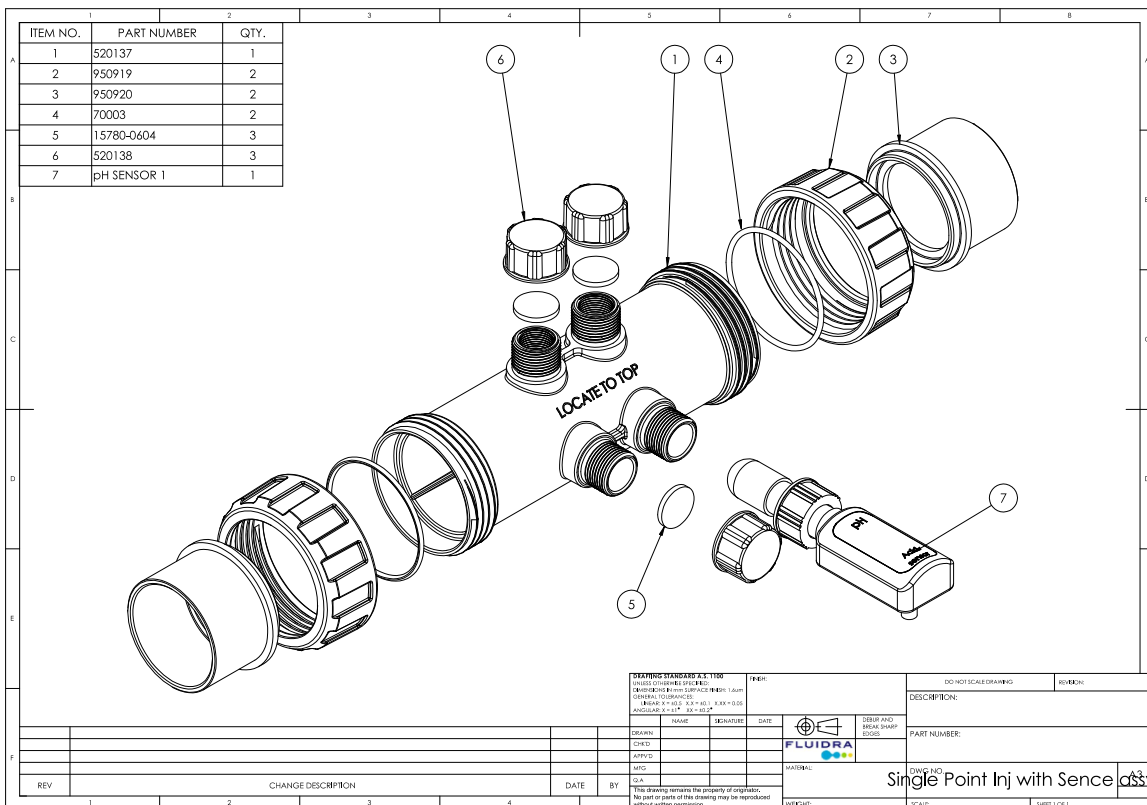

6.4 Installation of the Chlorine Sensor

If you have chosen to have the pH sensor installed, you can now choose to have the chlorine sensor installed. The chlorine sensor takes away the need to test the chlorine level in your pool and allows the Viron e-Equilibrium to automatically control the chlorine and pH levels of your pool and spa water. This option is highly recommended for pool and spa combinations, spa pools and indoor pools and spas.

The chlorine sensor is provided with a 3 metre RJ12 cable for connection to a Viron variable speed energy efficient pump. However, the chlorine sensor is simply screwed into the pH sensing chamber and connected to the bottom of the Viron e-Equilibrium controller. Once connected, the e-Equilibrium will automatically detect the sensor and the factory preset chlorine level of 600 mv will operate.

 Locate the Sensing Chamber as per section 6.4 before the Chlorinator Cell. The sensor chamber must have the acid dosing point installed away from the chlorine and pH sensors. Therefore install the acid dosing point after the chlorinator cell and the chlorine and pH sensors before the chlorinator cell.

 Assembly of the Chlorine Sensor. Remove rubber boot from sensor and screw into the sensor chamber which is glued into pipework either before filter or between filter and Chlorinator cell.



The Chlorine Sensor uses Oxidisation Reduction Potential readings to determine the chlorine level in your pool or spa water.

ORP is the most reliable and safest way to determine the level of the sanitiser in your water but is affected by other factors influencing the efficiency of the chlorine. Water pH, the use of sunscreens (cyanuric acid), Hardness and other items can all influence the reading of the ORP.

The Viron e-Equilibrium will adjust the production of chlorine to meet the ORP which MAY mean the chlorine level, when measured in simple PPM (parts per million) levels, may change from time to time. This is normal and no cause for concern. An example of higher chlorine readings when measured in ppm is if the acid runs out and is not replaced. In this case, the pH will start to increase and the effectiveness of the chlorine will reduce. As the chlorine effectiveness reduces the ORP measurement declines and the Viron e-Equilibrium will increase the power to the electrode cell to produce more chlorine. Once the pH level is corrected the Viron e-Equilibrium will reduce or turn off the power to the electrode cell as the ORP reading will rise.

When the pH and chlorine sensors are connected, the Viron e-Equilibrium LCD screen will display the additional following messages:

Chlorine Level – (chlorine low, chlorine OK, chlorine high)
Cell was operating at (percentage of maximum output, or “off”)

pH set point (factory preset at 7.6)

pH actual (will read close to set point providing acid container has acid available to be dosed)

For some installations, such as commercial pools it may be beneficial to display the actual ORP reading instead of "Chlorine OK, Chlorine High or Chlorine Low". **Generally, this is not recommended for residential applications.**

Within the INSTALL MENU the following screen is displayed:



The default value is No, so that during operation the screen will only display "Chlorine OK, Chlorine High or Chlorine Low". Use the arrows up or down to change the default to "YES" and the screen will then display actual ORP levels.

⚠️ ORP readings will vary when the filter pump is off and will also vary if Cyanuric Acid is present in the water. Daylight hours will show a reduced ORP while night time will allow the Cyanuric Acid to detach from the chlorine molecule which will increase the ORP reading. ORP readings should only be recognised while the pump is operating and during daylight hours.

7.0 General Operation/Pool Chemistry

7.1 Setting the Right Chlorine Output and Filtration Time

Your e-Q chlorinator must be run every day to ensure that your pool is correctly sanitised. As the sun dissipates chlorine, running times are higher in the summer compared to the winter. AstralPool recommend that you initially run your chlorinator at maximum output on level 8.

Summer

You should set your Chlorinator to operate for 8 to 10 hours per day. Ideally, run it for 4-5 hours in the morning (say 8-12pm) and 4-5 hours in the evening (say 6.00-11pm).

In extremely hot weather it may be necessary to extend the running time if you find that the free chlorine level is too low.

Winter

You should set your Chlorinator to operate for 6 to 8 hours per day. Again, running it in the morning and evening is preferable. A lower chlorine output level may be selected.

7.2 Checking Chlorine Level.

Ideally, check your Chlorine level after the morning operating period. The free chlorine residual level should be somewhere between 1 and 3 parts per million. Increase or decrease the output of the Chlorinator to get the right residual chlorine level. It may also be necessary to adjust the operating period if you are running at minimum or maximum output.

7.3 Stabiliser

AstralPool do not recommend the addition of stabiliser in a pool controlled with an e-Q chlorinator with chlorine probe fitted. If Dichlor or Trichlor is used to supplement the chlorine production of the e-Q chlorinator or Cyanuric Acid is added to the pool, the set point of the chlorine (ORP) should be turned down. Refer to Section 10.1 of this operating manual.

7.4 pH Level

You should keep your pH level between 7.0 and 7.4 for fibreglass pools and 7.2 to 7.8 for other pools.

7.5 Total Alkalinity

The ideal range is between 80 and 120 ppm.

7.6 Salt Level

Salt level should be maintained around 4,000ppm but should never be allowed to fall below 3,000ppm. Although salt is not consumed by the Chlorinator, salt is lost during backwashing, and when your pool overflows due to rain or splashing. The correct salt level is important to cell life and the effective operation of your chlorinator.

A typical pool of around 50,000 litres requires 200kg of salt to initially set-up the pool to 4,000ppm.

A low salt level warning is indicated on your e-Q Chlorinator if the salt level drops. If Low Salt is indicated, check again in 24 hours and then if it is still indicated, add two 25kg bags of salt to the shallow end of your pool. Run the filtration system for approx. 6 hours to help mix the salt in the pool. It can take up to a day for the salt to fully dissolve.

If the low salt light is still on, then you should get your pool water tested. If the Salinity is above 4000ppm then you may need to have your Chlorinator checked.

Warning: Some people recommend that you put salt directly in the skimmer box. This is a very bad practice as it allows very high concentrations of salt to be passed through your filtration and other pool equipment.

7.7 ACID Handling

Hydrochloric Acid should be handled with extreme care. Refer to Material Safety Data Sheets on Hydrochloric Acid. Do not inhale Acid fumes. Do not spill and handle with extreme care during transport. Use protective gloves and goggles.

In the case of spillage wash down with fresh water immediately. Keep out of reach of children.

8.1 Acid Pump squeeze tube:

Inst315 – Viron e-Quilibrium Series Chlorinator Instructions Vo8-15

Acid pump squeeze tube must be lubricated every 6 months or more often in commercial applications. Use only the recommended lubricant RC Tube Lube available from AstralPool or any other compatible silicone lubricant, otherwise damage to the tube is possible.

Depending upon usage, the squeeze tube may need replacement after 12 months on a domestic installation, and earlier on a commercial installation. Before replacing the tube make sure that any stop valves in the filter system are closed. Otherwise water loss may occur.

(To replace the tube, remove controller drawer, remove retaining screws from the pump head and pull the tube free.

Disconnect the squeeze tube from the barbs and reconnect the new squeeze tube after lubricating the same, making sure that the new tube is correctly connected to the PVC tubing as per instructions. Reposition the squeeze tube in the unit as before, replace the pump head and retaining screws.) **DO NOT OVERTIGHTEN THE RETAINING SCREWS.**

8.2 Sensors:

The sensors are sensitive instruments. To maintain their accuracy they should be cleaned periodically by household detergent abrasive like Jif. Jif is the preferred option. The Chlorine Sensor tip can be contaminated (generally observed by a copper or brownish coating – this should always look shiny gold) which will give a false reading to the Controller causing no dosing/over dosing of chlorine. As the pH sensor tip is made of glass, please take care, for even a hairline crack can cause the sensor to read incorrectly causing malfunction.

After cleaning the sensors, wash with water, allow 5-10 min. to settle and check calibration or re-calibrate if necessary.

Note, the chlorine sensor may take 30 to 45 minutes to settle and provide the correct reading.

8.3 Swimming Pool Applications and the use of Cyanuric Acid

USE OF A SUN SCREEN CHEMICAL (CYANURIC ACID) FOR OUTDOOR POOLS IS RECOMMENDED.

CHECK WITH YOUR LOCAL POOL SHOP AND USE THE CORRECT DOSAGE. ENSURE YOUR POOL WATER IS WELL BALANCED WITH THE CORRECT pH, TDS, TA AND STABILISER LEVELS AND FREE FROM PHOSPHATES.

9.0 Ai Mode – complete automatic control of your Pool & Spa

Ai Mode is a unique Patent applied for system that controls the filtration and chlorine levels in your pool with three primary objectives:

Completely turnover your pool water every day so that the organic material which looks unsightly and which feeds algae and bacteria is removed from your pool.

Ensures the correct sanitizer level is achieved to destroy any pathogens, algae and bacteria in the water.

Minimizes the cost of operating your pool and spa.

9.1 Ai Equipment requirements

For your Viron e-Quilibrium to operate in Ai Mode you will need the following equipment:

A Viron e-Quilibrium

pH sensor

chlorine sensor

RJ12 communications cable

Viron eVo variable speed pump

9.2 Ai Mode Connection

Connect your Viron eVo pump to the Viron e-Quilibrium with the RJ12 communications cable and plug the 3 pin plug into the bottom.

9.3 Ai Mode set up

In the Viron e-Quilibrium "Set Up" screen enter "INSTALL" menu and enable the following:

3 speed pump enabled

the volume of your pool and spa in litres (if no spa is installed, leave this at factory pre set level)

select Ai Mode

Select the size Viron Pump you have installed (1.0 hp for P320 and 2.0 hp for P600)

Select the speed of the pump when you have the system manually on – we recommend speed 1 or high speed.

Select "Continue" set up when asked.

the number of complete water turnovers required each day, (suggest factory preset of 1.5 times is adequate)

When asked "Reset to Factory Defaults?" select no.

Finally, exit the "Install Menu" and change the timer period to operate for as long as possible (suggestion of 16 hours – from 8 am to 10 pm)

9.4 Viron eVo Pump speed selection:

- Enable System mode in the Viron Pump menu – refer to Viron Pump Instructions

- Set Pump speeds as follows: Once the RJ12 Cable has connected the pump and eQ Chlorinator, change the chlorinator mode to “Manual On” to enable adjustment of the Pump Speeds. Note, once the pump is turned Manual On, it will go into Priming Mode for 5 minutes before the speeds can be changed. Alternatively, set up the pump speeds before the RJ12 connector is plugged into the chlorinator. Once the pumps speeds have been set up, ensure the SYS (system) mode is enabled in the Viron Pump Menu.
- In Ai Mode, the high speed should be set at near maximum speed of the pump.
- Medium speed should be set at a speed where the chlorinator electrode cell fills with water during operation and the skimmer box weir door creates some surface tension on nearby water to skim properly. Usually, this speed will be between 1200 and 1600 RPM.
- Low speed should be selected at 600 RPM. This speed will be referred to as sampling speed. Ensure water is flowing through the chlorinator cell at this speed.

9.5 Operation in Ai Mode.

When Ai Mode is selected the Viron e-Quilibrium will operate in the following manner:

- The pump and electrode cell will start at the first time period. After the initial 5 minute priming period, the pump will revert to filter speed (medium speed), the Viron e-Quilibrium will test pH and chlorine levels and both adjust the chlorine production and dose acid to achieve the desired levels.
- The Viron e-Quilibrium will ensure the pump operates until its primary two objectives are achieved: (1) the Water is turned over 1.5 times (on a 50,000 litre pool, the pump will move 75,000 litres of water to ensure all of the water is filtered) and (2) the chlorine level is achieved. In the winter, this may be only 4 to 6 hours of operation. In the summer, when the pool is subject to high UV and heavy bather load it may be 12 hours as the chlorine level is constantly under demand.
- When both objectives are achieved, the Viron e-Quilibrium will turn the pump down to Sampling Speed (approx.600 RPM) which is almost inaudible and costs less than 0.5 cents per hour. During Sampling speed the Viron e-Quilibrium simply tests for chlorine levels. If the family all jump in the pool later at night and the chlorine is dissipated, the Viron e-Quilibrium will turn the pump back to filter speed (medium) and turn the electrode on to produce more chlorine. Your family is protected even when swimming later at night as the system is filtering and sanitising the pool or spa water automatically.
- Finally, if the correct chlorine level is NOT achieved when the system shuts down at the end of the day on time clock, it will start on maximum output and maximum pump speed the following morning until the chlorine level is achieved. Once the chlorine level is achieved, the pump will revert back to the gentle filtration speed until the required number of water turns and chlorine levels are maintained.
- In Ai Mode you can select four timer periods. Each timer period can have a specific pump speed selected (high or medium) or allow the Chlorinator to select the appropriate pump speed. Normally you will only select a specific pump speed when you wish to operate a cleaner or water feature at a specific time every day. Low speed cannot be selected in Ai Mode as low speed becomes the default “sampling speed” to allow the unit to continue to monitor chemical levels while the Viron Pump is operating at a very low output.

9.6 Effects of Ai Mode

Ai Mode will automatically adjust operating times, pump speed (when Viron variable speed pumps are installed) and chlorinator output to suit the weather conditions and bather load.

Priority one is to produce sufficient chlorine to make the pool clean, healthy and ideal to swim in.

Priority two once the pool is clean is to reduce operating costs by automatically reducing the pump speed.

It is important, during set up, that the pool (and spa, if applicable) volume is inputted correctly. The average pool size in Australia is between 50,000 and 60,000 litres but if in doubt, it is better to select more volume than less.

When chlorine is low, Ai mode will change the Viron Pump (if installed and connected) to high speed. The high speed can be adjusted up or down in the set up and commissioning stage. High speed operation and high chlorine output will continue until the chlorine reading is near the set point. Once the chlorine level nears set point, Ai mode will turn the pump speed back to medium and reduce the output on the chlorinator to prevent “overshooting” of chlorine levels.

When the chlorine level is satisfied and the pump has operated long enough to complete the pool water turnover inputted into the Chlorinator set up menu (factory preset at 1.5 turns), the chlorinator will turn the pump down to low speed, stop producing chlorine and dosing acid, but continue to sample the chlorine level. Low speed should be adjusted to approximately 600 to 800 RPM during set up.

If the chlorine level drops significantly while in Ai mode, the eQ will turn the pump back to medium speed (from low speed) or to high speed (from medium speed). At the same time, the chlorine output will automatically be adjusted. The goal is to produce chlorine as quickly as possible and vigorously circulate chlorinated water to all parts of the swimming pool.

You will notice a difference in the operating hours, pump speed and chlorinator output between winter and summer as the unit adjusts to weather and environmental conditions.

9.7 Extended Operating hours and high speed pump operation

Should Ai mode keep your pump in high speed for most of the day perform the following checks:

1. Manually test the water (from in front of skimmer or inlet to the circulating pump) for the chlorine level. If the chlorine level is high (above 3ppm) turn the chlorine setting on the chlorinator down. (Refer to section 10.1)
2. If the chlorine level is low and stays low throughout the day, try extending the operating hours of the Chlorinator into the morning or late at night. Chlorine produced at night will stay in the water for longer and build up a residual which may be enough to counter the effects of strong sunlight and bather load on hot days.
3. Check the salt or mineral level in your pool water. Higher levels (do not exceed 6000 ppm) of salt/minerals will enable higher chlorine production.

After these checks, if the pump stills runs on high speed for most of the day, you can sacrifice circulation by reducing the high speed setting on the pump

For further information on the set up and operation of the Viron e-Quilibrium go to Youtube on the following links:

Sensor/Probe and RJ12 Connections-

<http://youtu.be/Og89iyocWFw>

Install Menu Part 1 -

<http://youtu.be/FPWZnp45Wyl>

Setting pH & Chlorine Levels -

<http://youtu.be/jQLrMCDZ9FI>

Setting the Clock -

<http://youtu.be/LxYU1cZqFlg>

Setting Timers for Ai Mode -

<http://youtu.be/ro1PA1a6zfa>

Install Menu Part 2 -

<http://youtu.be/AqRg2-cvrfI>

Statistics Feature -

<http://youtu.be/c0DfntoFTOo>

Sensor Chamber & Dosing Point Installation -

<http://youtu.be/3eIrkH89uBE>

10.0 Important Information about Chlorine Sensing by the e-Quilibrium

The Viron e-Quilibrium uses an ORP sensor to measure and control the chlorine levels in your swimming pool or spa.

 **Before installing probes, balance pool water. Total Alkalinity (TA) must be 80 to 120 ppm, Calcium Hardness should be 180 to 250 ppm, and pH must be between 7.2 and 7.6.**

 **Dose pool with a small amount of chlorine before starting the e-Q. If no chlorine is sensed the e-Q may go to fail safe mode and not start up. Some Chlorine should be present before starting the unit.**

 **The Chlorine sensor will take 45 minutes or more to accurately sense the chlorine level in the pool. Allow Pool pump to run for 45 minutes before attempting to calibrate the sensor to the pool water.**

Confusion often exists about the difference and relationship between oxidization reduction potential (ORP) and chlorine levels measured in parts per million (ppm).

Most pool shops and pool service technicians will focus on chlorine readings in ppm and not the ORP.

ORP is actually a more accurate and important reading than ppm because it measures the effectiveness of chlorine and NOT the level of chlorine in the water. Relying on ppm can provide a false sense of security and may even lead to use of a pool that is dangerous to swim in.

When chlorine is added to the water it reacts to form two separate chemicals, one is hypochlorous acid (HOCl) and the other is hypochloric acid (HCl). The important chemical to form is HOCl as it is the active or effective form of chlorine which oxidizes and disinfects the contaminants in the water.

The amount of HOCl and HCl formed depends on the pH of the water. The higher the pH, the less effective HOCl is formed and the more ineffective HCl is formed. Ideally, a pH range of 7.2 to 7.6 forms the most HOCl while maintaining soothing water to swim in.

At a pH of say 7.8, only 30% effective HOCl will be formed which means the chlorine is not being effective as disinfecting the pool or spa water even though the ppm is 2 or 3 ppm.

However, at a pH of 7.2, a massive 80% effective HOCl will be formed meaning the chlorine is highly effective as disinfecting the water even at levels of 1ppm.

ORP remains the best method to measure the sanitiser's (chlorine's) effectiveness in the water. At a reading of 750mv a virus kill time is as low as one second!

Various other chemicals added to the water can affect the ORP. For example, most pools will have cyanuric acid added to the water which effectively slows down the reaction of the chlorine to make it last longer. However, the slower reaction time of the chlorine lowers the ORP, hence the e-Quilibrium will add more chlorine to maintain the ORP and keep your pool healthy and safe to swim in.

The important point here is that provided your chlorine sensor (ORP sensor) is checked, cleaned and calibrated every 6 months, your Viron e-Quilibrium will maintain the pH and sanitizer levels for the more comfortable and healthiest swimming conditions.

10.1 Chlorine Reading and Cyanuric Acid

Cyanuric Acid (CyA) is often recommended by or added to swimming pools to make the available chlorine last longer. It is often called stabiliser or sunscreen. CyA bonds with chlorine ions which prevents the chlorine from oxidizing bacteria and other contaminants. This effectively reduces the oxidization reduction potential (ORP) of the chlorine in your pool.

Chlorine efficiency or activity is reduced even when low levels of CyA is present.

Total Alkalinity (TA) buffers pH or keeps the pH relatively stable. The pH of your pool water is crucial to making your chlorine highly effective, even when the chlorine is present in low levels. Measuring and adjusting your TA on a regular basis will help reduce acid consumption and help keep your pH level in check. Variable pH will also create variable ORP readings with high pH meaning your e-Q Chlorinator will produce more chlorine to reach the set point ORP level than it would otherwise need.

CyA adds to the TA reading. If CyA levels of in excess of 50 ppm are present, it is good practice to divide the CyA by 3 and subtract the result from the TA reading. Therefore if CyA is 60, and TA is 200, subtract 20 (CyA 60/3) from 200 for a TA reading of 180.

CyA bonds to chlorine more effectively in sunlight hours. Therefore ORP readings will be lower in sunlight hours than at night. As the chlorine bonds with CyA during sunlight hours, the ORP may drop more than 100 mv. This means the e-Q chlorinator will drive higher levels of chlorine during sunlight hours as the chlorine is temporarily bonded with CyA. After sunset, the CyA bond with chlorine will reduce, freeing up the chlorine to oxidise with bacteria and exhibiting an increased oxidization potential reading on the e-Q chlorinator.

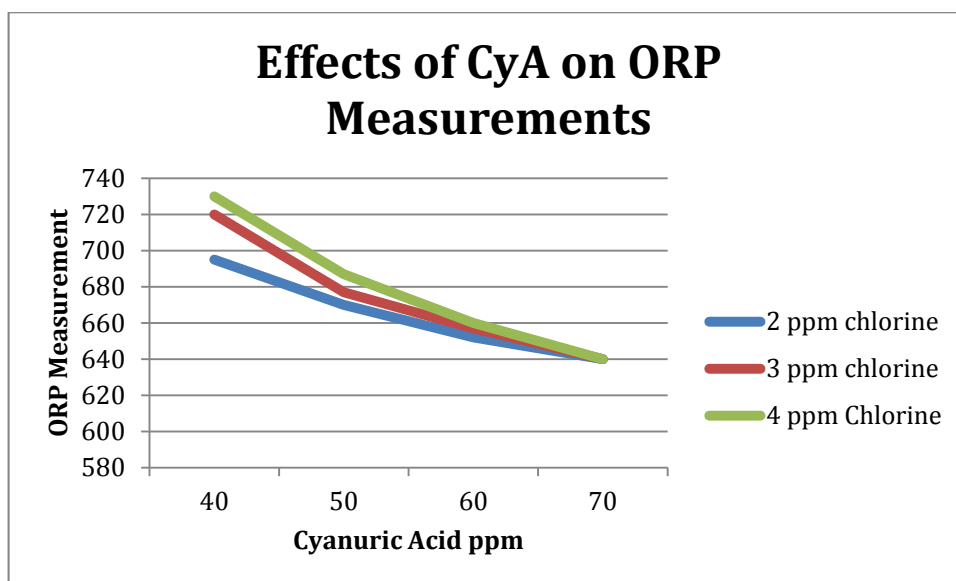

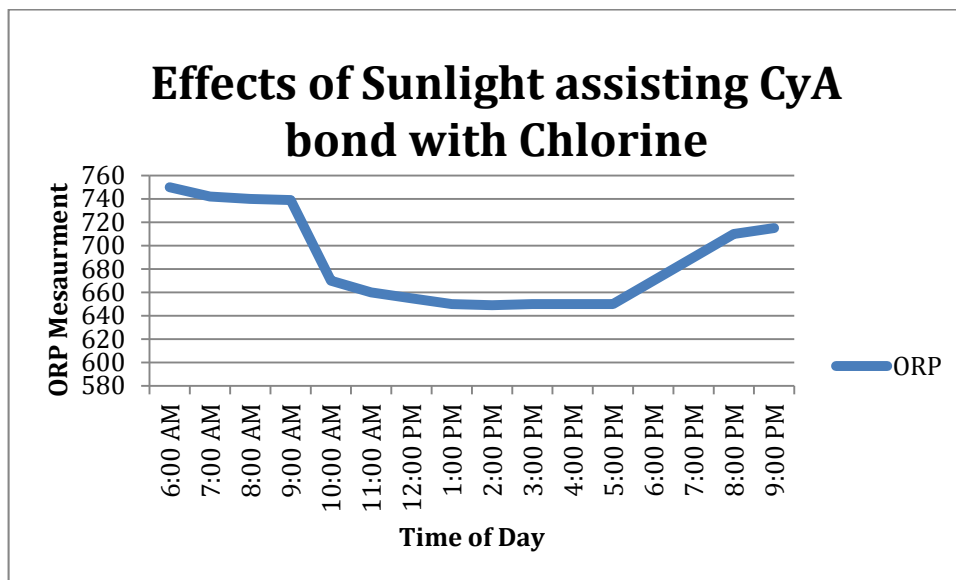

Why use CyA at all? CyA is used to extend the life of chlorine when the chlorine is manually added in the form of a tablet, granules or liquid and it is not monitored by a measuring device. This reduces the quantity and cost of chlorine used and maintains a residual chlorine in the pool even though manual dosing may take place every 2 or 3 days.

The AstralPool e-Q Chlorinator continually monitors and produces chlorine to suit the pool’s chlorine demand and costs very little to convert your pool minerals into chlorine. **AstralPool do not recommend the use of CyA in conjunction with a Salt Chlorinator that is suitably sized and incorporates a chlorine (ORP) sensing device to produce chlorine.** This includes adding CyA to the pool or supplementing the chlorinator with Dichlor or Trichlor, both of which have CyA as an active constituent. **In particular, CyA should not be used in a covered pool, indoor pool or a spa pool.**

At most, CyA should be managed and kept within a range of 10 to 20 ppm when used in conjunction with the e-Q chlorinator installed with the Chlorine Sensor. Ongoing use of Trichlor or Dichlor will continue to raise the level of CyA causing a reduction in the activity of the chlorine and may cause your e-Q Chlorinator to continue to raise the chlorine levels to excessive levels in order to reach the chlorine set point (ORP).

If CyA is present in the pool water or Trichlor or Dichlor is used to supplement the Chlorinator’s chlorine production then the ORP set point should be adjusted downwards until a chlorine level of between 2 and 5 ppm is achieved and maintained. Consult your pool professional or certified Viron Installer to adjust your Chlorine (ORP) set point.

As a guide, the following set point ORP levels can be used as a starting point to achieve a consistent and reasonable chlorine level.

Guide to adjusting the Chlorine (ORP) set point

Constants: pH at 7.6, TA at 180 ppm

Cyanuric Acid Level	Chlorine Level		
	2 ppm	3 ppm	4 ppm
0	700 mv	725 mv	750 mv
10	550 mv	600 mv	625 mv
20	500 mv	525 mv	550 mv
>50	350 mv	400 mv	450 mv

Check your chlorine after 48 hours and adjust the chlorine (ORP) set point up or down as necessary.

11.0 Fault Indication and trouble shooting

Fault Indication	Potential Cause	Remedy
No Flow	Pump turned off/disconnected or valves closed Sense wire disconnected from cell	Ensure valves/pump on Connect sense wire to cell
Low salt	Salt level in pool has dropped too low Pool water temperature is low Cell has failed	See section 7.5 above Increase salt level or raise water temperature Call a technician
Display blank	No Power to Controller Fuse blown	Plug in controller and ensure mains power available Call a technician
Low/No chlorine production	Cables not connected to cell Timer period too short Chlorine output level too low Filter needs backwashing Pool stabiliser too low Salt level too low Water Temperature below 15 deg Excessive Salt Level (Above 10,000 ppm) The e-Q has locked out on fail safe with very low chlorine levels present (less than 100 mv ORP)	Connect cables Increase timer period Increase chlorine output Backwash filter Get Stabiliser between 30 and 60 ppm Increase salt to 4000ppm Increase water temperature or salt level Chlorinator cuts out on overload, reduce salt level to 4000 ppm Test Chlorine levels and add chlorine to pool. Start pool pump and allow one hour for sensor to read chlorine levels
Pool water cloudy	Chemical balance in incorrect Acid container empty ORP level set too low Pool water volume set too low in install menu Insufficient Water flow Insufficient water turnovers each day	Test Water and adjust as needed pH 7.2 to 7.6, TA to 120 ppm and CH to 180ppm Replace Acid Container Set ORP to 700 mv Increase pool water volume Increase variable speed of pump Increase water turns in Install menu
pH too high	Probe/sensor malfunction	Clean and Calibrate probe/sensor
Chlorine too high	ORP level is set too high Total Alkalinity too low ORP sensor is not immersed in pool water Cyanuric Acid (Chlorine Stabiliser) is present in pool	Reduce to between 600 and 650 mv ORP Test TA and adjust to 80 to 120 ppm Install sensor chamber so that it is always in pool water Lower ORP set point as in section 10.1

11.1 REGULAR MAINTENANCE

Your Viron e-Quilibrium Chlorinator requires regular maintenance to sense the chlorine and pH levels accurately and to safely dose the pH adjuster (hydrochloric acid).

Frequency	Maintenance Description
Weekly	Check Acid level and replace or top up as required
Monthly*	Manual test for pH and chlorine and adjust eQ set point as required
Twice Yearly***	Using a cotton bud and Jiff (non abrasive cleaner) clean pH and chlorine sensor. Rinse in clean water or clean pool water. Re install, allow 24 hours to settle and sense correct levels. Adjust set points or calibrate sensors as required
Twice Yearly***	Inspect Acid tube, peristaltic pump squeeze tube condition for cracks, wear and tear. Replace as required
Monthly*	Test and adjust Total Alkalinity, CyA levels, and Calcium Hardness levels and adjust to levels recommended by your professional pool shop or service technician

* AstralPool recommend your water tests are conducted by a professional pool shop or service technician. Use a clean sample bottle and take sample from approximately 30 cm below water level. Take sample to pool shop immediately. Water Sample bottles can usually be obtained from your local professional pool shop.

***We recommend you engage a pool professional to test, clean and calibrate your pH and chlorine sensors.

12.0 WARRANTY

AstralPool Australia Pty Ltd (ABN 97 007 284 504) ("AstralPool") provides the following warranty in relation to its Viron series salt chlorinator ("Product").

Our goods come with guarantees that cannot be excluded under the Australian Consumer Law. You are entitled to a replacement or refund for a major failure and for compensation for any other reasonably foreseeable loss or damage. You are also entitled to have the goods repaired or replaced if the goods fail to be of acceptable quality and the failure does not amount to a major failure.

The benefits of this warranty are in addition to any rights and remedies imposed by Australian State and Federal legislation that cannot be excluded. Nothing in this warranty is to be interpreted as excluding, restricting or modifying any State or Federal legislation applicable to the supply of goods and services which cannot be excluded, restricted or modified.

WARRANTY

AstralPool warrants that, subject to the exclusions and limitations below, the Product will be free from defects in materials and workmanship during the warranty period. The warranty periods are set out below and commence 30 days after the date of purchase (to allow for installation). The warranty period may vary for different parts of the Product.

Parts	Warranty Period
Control box including PCB's	5 years pro rata 0% payable of invoice total year 1 20% payable of invoice total year 2 40% payable of invoice total year 3 60% payable of invoice total year 4 80% payable of invoice total year 5
pH and chlorine Sensors, dosing motor/gearbox and associated tubing/fittings	12 months
Chlorinator cell electrode	5 years

If a defect appears in the Product before the end of the warranty period and AstralPool finds the Product to be defective in materials or workmanship, AstralPool will, in its sole discretion, either:

- (a) Replace or repair the Product or the defective part of the Product free of charge; or
- (b) Cause the Product or the defective part of the Product to be replaced or repaired by an Authorised AstralPool Service Agent free of charge.

AstralPool reserves the right to replace defective parts of the Product with parts and components of similar quality, grade and composition where an identical part or component is not available.

Goods presented for repair may be replaced by refurbished goods of the same type rather than being repaired. Refurbished parts may be used to repair the goods.

WARRANTY CLAIMS

1. If a fault covered by warranty occurs, the customer must first contact AstralPool at the contact address listed below, or an Authorised AstralPool Service Agent.
2. Any warranty claim must be accompanied by:
 - (a) Proof of purchase;
 - (b) Full details of the alleged defect; and
 - (c) Appropriate documentation (such as historical and maintenance records).
3. The customer must make the Product available to AstralPool or its Authorised AstralPool Service Agent for inspection and testing. AstralPool or its Authorised AstralPool Service Agent will attend the premises where the Product is installed for inspection and testing. If the Product is installed:
 - (a) Outside a capital city metropolitan area; and
 - (b) is not within a 20 km radius of an Authorised AstralPool Service Agent;Then the customer may have to pay a travel fee.

4. If such inspection and testing finds no defect in the Product, the customer must pay AstralPool's usual costs of service work and testing. If such inspection and testing finds a defect that is not covered by this warranty, the customer must pay AstralPool's usual costs of service work plus any parts and labour required to repair the Product, unless recoverable from AstralPool on the failure of any statutory guarantee under the ACL.

Exclusions

The warranty will not apply where:

- (a) The customer is in breach of the Terms and Conditions of Sale;
- (b) The Product was used for a purpose other than one it was intended for;
- (c) The Product was repaired, modified or altered by any person other than AstralPool;
- (d) The Product has not been installed, maintained and/or operated in complete compliance with the installation and operating instructions and any instructions by AstralPool;
- (e) The Product has been subject to accident, negligence, alteration, abuse or misuse.

The warranty does not extend to:

- a) Normal wear and tear;
 - b) Weather and other environmental conditions including but not limited to storm, flood, and/or heat wave damage;
- or
- c) Service and maintenance items.

Examples of exclusions include but are not limited to:

- Cleaning and calibration of probes

Commercial Installations

On commercial installations, such as health clubs, motels/hotels and hydrotherapy facilities, the warranty is limited to parts and in field labour (within capital city metropolitan areas or 20 km radius of Authorised AstralPool Service Agents) for a period of 12 months from the date of purchase plus 30 days to allow for installation.

LIMITATIONS

AstralPool makes no express warranties or representations other than set out in this warranty.

The repair or replacement of the Product or part of the Product is the absolute limit of AstralPool's liability under this express warranty.



INST315



sales@astralpool.com.au
www.astralpool.com.au