



britax

safe·n·sound

CONVERTIBLE CAR SEAT
WITH OPTIONAL ISOFIX COMPATIBILITY
Suitable for Birth to 4 years (approx)

Instructions for Installation & Use

Series No. 7300/E/2013

Series No. 7300/E/2013/i

Series No. 7300/F/2013

Series No. 7300/F/2013/i



Scan for video
instructions



**REARWARD
FACING**

Birth to 2-3
years (approx)



**FORWARD
FACING**

12 months to 4
years (approx)



**ISOFIX
COMPATIBLE**

If you have purchased an
ISOFIX compatible version
then ISOFIX compatible straps
are fitted the seat.



IMPORTANT:

KEEP THIS BOOKLET IN THE PLACE PROVIDED ON THE CHILD RESTRAINT

SEATBELT QUICK SETUP REARWARD FACING

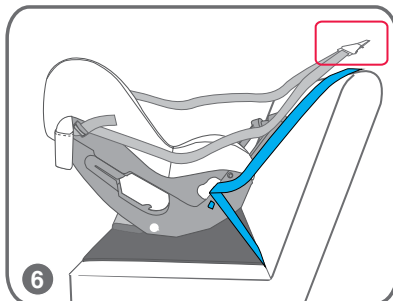
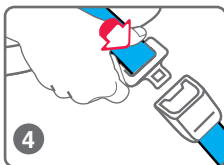
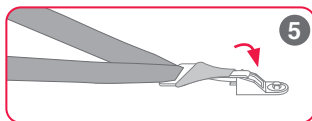
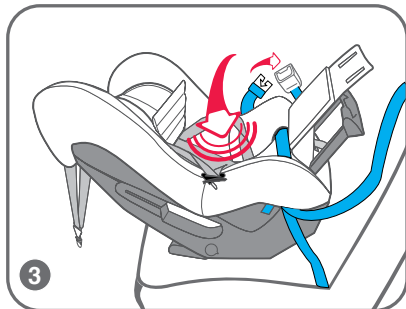
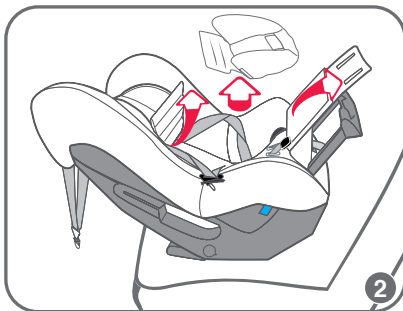
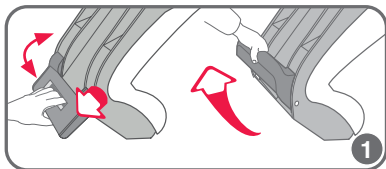

SEE PAGE 28 - 35 FOR FURTHER INFORMATION

SEATBELT QUICK SETUP REARWARD FACING

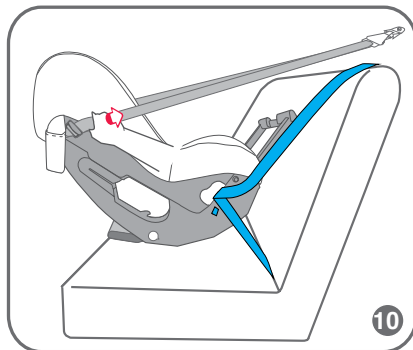
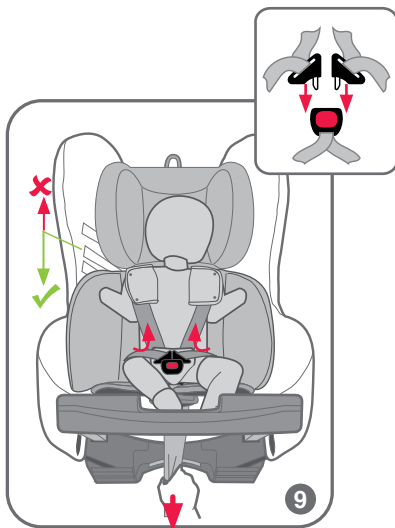
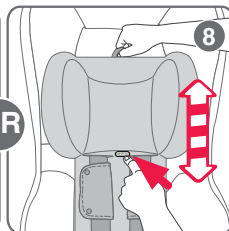
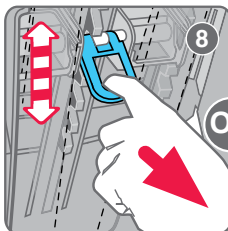
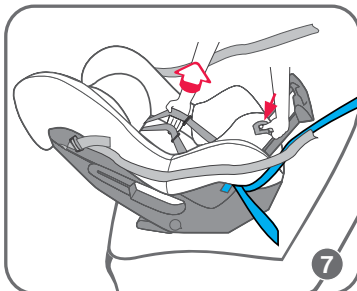

SEE PAGE 28 - 35 FOR FURTHER INFORMATION

SEATBELT QUICK SETUP FORWARD FACING

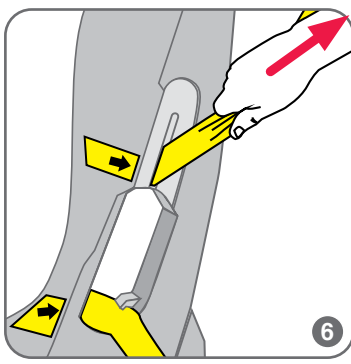
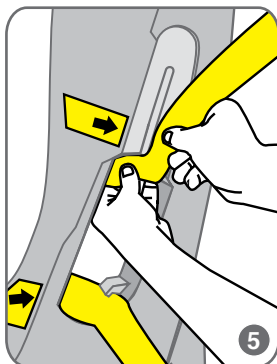
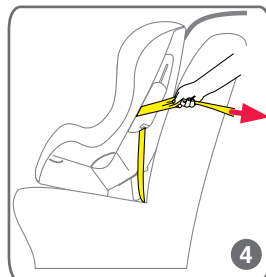
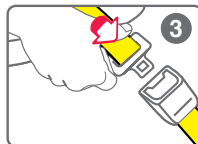
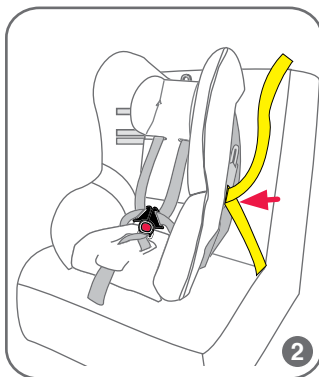
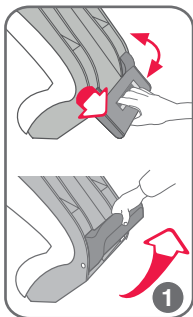

SEE PAGE 58 - 62 FOR FURTHER INFORMATION

SEATBELT QUICK SETUP FORWARD FACING

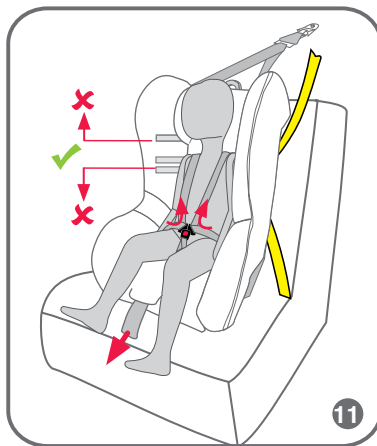
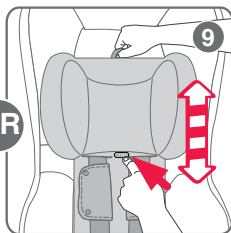
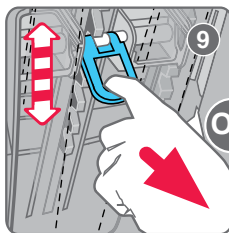
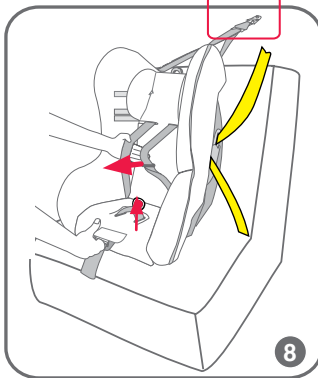
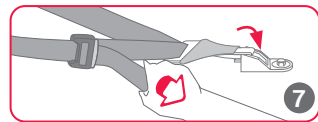

SEE PAGE 58 - 62 FOR FURTHER INFORMATION

ISOFLEX QUICK SETUP REARWARD FACING

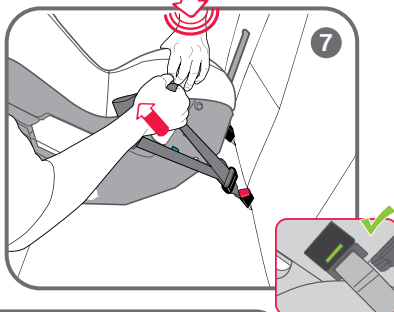
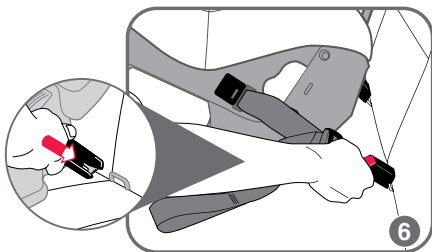
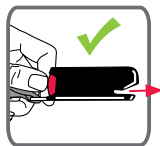
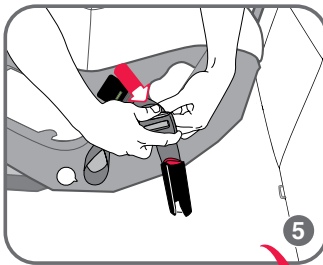
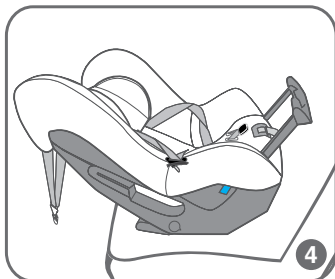
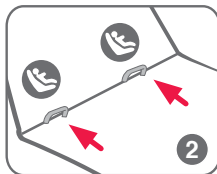
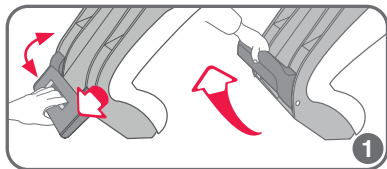

SEE PAGE 36 - 41 FOR FURTHER INFORMATION

ISOFLEX QUICK SETUP REARWARD FACING

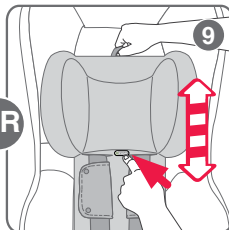
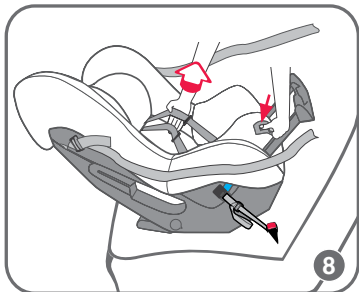

OR

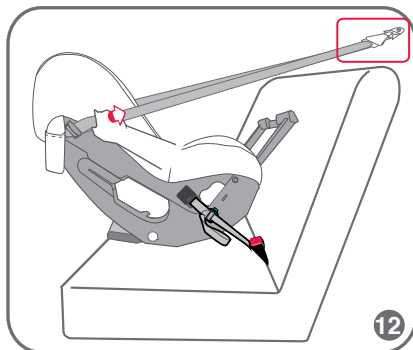
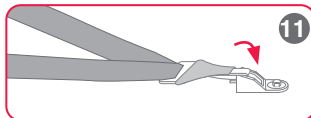
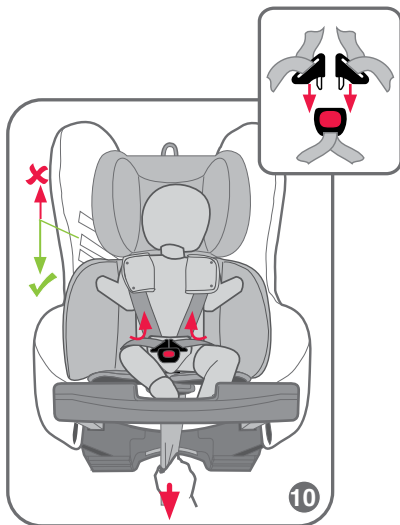

SEE PAGE 36 - 41 FOR FURTHER INFORMATION

ISOFLEX QUICK SETUP FORWARD FACING

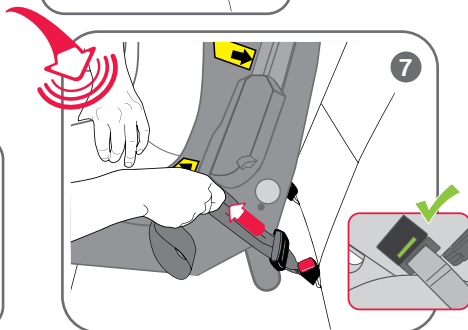
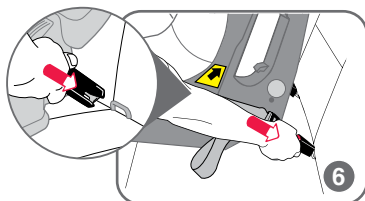
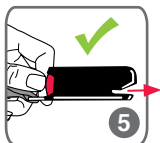
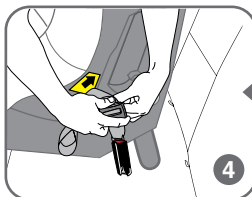
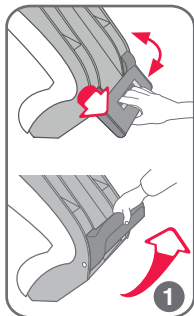

SEE PAGE 63 - 66 FOR FURTHER INFORMATION

ISOFLEX QUICK SETUP FORWARD FACING

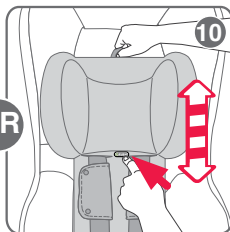
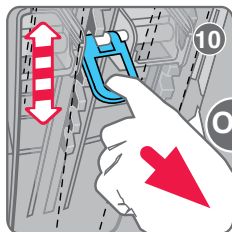
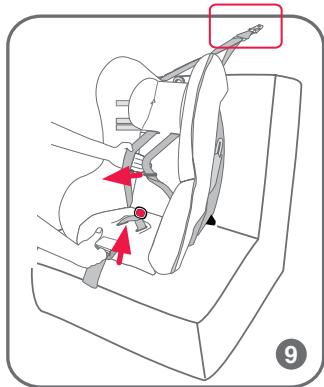
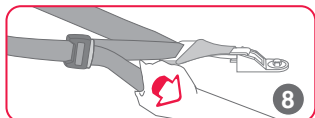

OR

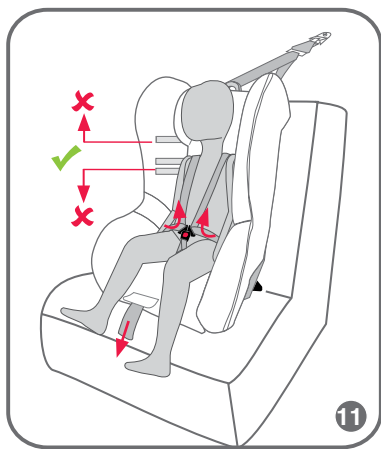

SEE PAGE 63 - 66 FOR FURTHER INFORMATION



INTRODUCTION

To be used only in a rearward-facing position until the infants's shoulders either reach the lower shoulder height marker (approximately 12 months of age) or reach the middle height marker (approximately 2 to 3 years of age). Then to be used in a forward-facing position until the child's shoulders reach the upper shoulder height marker (approximately 4 years of age).

Continue to use this child restraint until the child reaches this limit.

Do not use forward facing until child's shoulders are above the lower shoulder height marker.

Infants are at risk of serious injury if they face forward too early.

Children are at risk of serious injury if they move to booster seats too early.

Children who have outgrown this restraint are safest in a larger child restraint with an in-built harness or a booster seat until their shoulders reach the upper shoulder height marker of the restraint.

فكتلال عافترال ةيفي لسلسلا ةراشإلا إللإ لإ لفطلال افتك لصي حتح ،فخل لئل ةه ءاوملا ةي عضولال يف طقف م ادختسالا
يف م ادختسالا مٲ .(رمعل نٲ تاونس 2-3 ي لاوح) فكتلال عافترال ةطسوت م ل ةراشإلا إللإ وأ (رمعل نٲ ارهش 12 ي لاوح)
(رمعل نٲ تاونس 4 ي لاوح) فكتلال عافترال ةيولعل ةراشإلا إللإ لفطلال افتك لصي حتح م امألل ةه ءاوملا ةي عضولال
؁حلا اذٲ إللإ لفطلال لوصو نل حل اذٲ ل لفظال زءا م ادختسا يف رم سلا
ةي لسلسلا فكتلال عافترا ةمالع نٲ م لعل أ لفطلال يف فتك نوكي ام دنع الل م امألل إللإ ةه ءاوملا ةي عضولال مدختست ال
مزاللا نٲ رثكأ ةركبٲ ةروصب م امألل إللإ مه هيءوت مٲ اذٲ ةري طءال تاباصلإلا إللإ ضرع تلل ةرطاخ م يف ءضرل نوكي
رثكأ ةركبٲ ةروصب ةفت رمل نامألل دعاقم لإ ولقلتنا ام اذٲ ةري طءال تاباصلإلا إللإ ضرع تلل ةرطاخ م يف لفظال نوكي
مزاللا مٲ.
نامألل دعقم وأ ةءدم ءاومل روكا ساقم وذ لفظال زءا يف انامألل رثكأ زءال اذٲ نٲ مءمء رُكب نل ذل لفظال نوكي
ءءا لئل ةيولعلال فكتلال عافترا ةمالع لإ م هفاتكأ لصت حتح عفت رم.

只用于后向式安装，直到婴儿的肩膀达到靠下的肩高标记（大约12个月的宝宝）或者中部的肩高标记（大约2-3岁的儿童）。然后用于前向式安装，直到儿童的肩膀达到靠上的肩高标记（大约4岁的儿童）。
在儿童达到该座椅上限以前必须不断使用这一安全座椅。
在儿童肩高未超过靠下的肩高标记之前不得采用前向式坐姿。
婴儿过早乘坐前向式座椅则可能受到严重的伤害。
儿童过早使用垫高椅则可能受到严重的伤害。
个子比该安全座椅大的儿童最安全的做法是乘坐设有内置安全带的更大汽车座椅或垫高椅，直到他们的肩膀达到该座椅靠上的肩高标记。



INTRODUCTION

Magagamit lamang sa isang nakaharap sa likod na posisyon hanggang sa maabot ng balikat ng sanggol ang alinman sa ibabang marka ng taas ng balikat (humigit-kumulang 12 na buwang edad) o maabot ang panggitnang marka ng taas (humigit-kumulang 2-3 taong edad). Pagkatapos ay magagamit sa nakaharap sa unahan na posisyon hanggang sa maabot ng mga balikat ng bata ang itaas na marka ng taas sa balikat (humigit-kumulang 4 na taong edad).

Ipagpatuloy ang paggamit ng pampigil ng bata na ito hanggang sa maabot ng bata ang limitasyong ito.

Huwag gamitin sa isang nakaharap sa unahan na posisyon hanggang sa malampasan ng mga balikat ng bata ang ibabang marka ng taas ng balikat

Ang mga sanggol ay nasa seryosong peligro ng pagkapinsala kung sila ay haharap ng masyadong maaga.

Ang mga bata ay nasa seryosong peligro ng pagkapinsala kung sila ay masyadong maagang ililipat sa mga upuang booster.

Ang mga batang napagkalakhan na ang pampigil na ito ay pinakaligtas sa isang mas malaking pampigil sa bata na may kasamang guwarnisyon o isang upuang booster hanggang sa maabot ng kanilang mga balikat ang itaas na marka ng taas ng balikat ng pampigil.

Sólo debe utilizarse orientado hacia atrás hasta que los hombros del niño alcancen el marcador de altura inferior (aproximadamente a los 12 meses de edad) o alcancen el marcador de altura medio (aproximadamente de 2 a 3 años de edad). Posteriormente debe utilizarse orientado hacia adelante hasta que los hombros del niño alcancen el marcador de altura superior (aproximadamente a los 4 años de edad).

Utilice este sistema de seguridad infantil hasta que el niño alcance ese límite.

No utilice la silla orientada hacia adelante hasta que los hombros no sobrepasen el marcador de altura inferior.

El niño corre el riesgo de sufrir lesiones graves si se utiliza la silla orientada hacia adelante antes de tiempo.

El niño corre el riesgo de sufrir lesiones graves si se lo traslada antes de tiempo a un asiento elevador.

El niño que ya no quepa en este sistema de seguridad estará más seguro en un asiento para niños más grande con un arnés incorporado o un asiento elevador hasta que sus hombros alcancen el marcador de altura superior del sistema de seguridad.



INTRODUCTION

Na χρησιμοποιείται μόνο σε θέση στραμμένο προς τα πίσω μέχρι οι ώμοι του βρέφους είτε να φτάνουν στον κάτω δείκτη ύψους ώμου (περίπου 12 μηνών) είτε να φτάνουν στον μεσαίο δείκτη ύψους (περίπου 2 με 3 ετών). Κατόπιν να χρησιμοποιούνται σε θέση που να κοιτάζει προς τα εμπρός μέχρι οι ώμοι του παιδιού να φτάνουν στον επάνω δείκτη ύψους ώμου (περίπου 4 ετών).

Συνεχίστε να χρησιμοποιείτε αυτό το σύστημα συγκράτησης βρεφών μέχρι το παιδί να φτάσει σε αυτό το όριο.

Μην το χρησιμοποιείτε στραμμένο προς τα εμπρός μέχρι οι ώμοι του παιδιού να είναι πάνω από τον χαμηλότερο δείκτη ύψους ώμων.

Τα νήπια κινδυνεύουν με σοβαρό τραυματισμό αν κοιτάζουν προς τα εμπρός πολύ χωρίς.

Τα παιδιά διατρέχουν κίνδυνο σοβαρού τραυματισμού, εάν μετακινηθούν σε βοηθητικά

Da utilizzare solo in posizione rivolta all'indietro fino a quando le spalle del bambino raggiungono il marcatore di altezza inferiore della spalla (circa 12 mesi di età) o il marcatore di altezza centrale (circa 2 o 3 anni). Dopo di che, può essere usato nel senso di marcia fino a quando le spalle del bambino raggiungono il marcatore di altezza della spalla superiore (circa 4 anni di età).

Continuare a utilizzare questo sistema di ritenuta del bambino fino a quando raggiunge questo limite.

Non utilizzare nel senso di marcia fino a quando le spalle del bambino superano il marcatore di altezza inferiore.

I neonati sono a rischio di lesioni gravi se messi in posizione frontale troppo presto.

I bambini sono a rischio di lesioni gravi se si muovono dal seggiolino troppo presto.

I bambini che hanno superato la marcatura sono più sicuri in un sistema di ritenuta per bambini più grande con imbracatura interna o in un seggiolino fino a quando le spalle raggiungono il marcatore di altezza superiore della spalla del sistema di ritenuta.

INTRODUCTION

केवल पीछे की तरफ मुँह कथि ह्ये स्थितिमें तब तक प्रयोग करे जबतक या तो शिशु का कन्धा कन्धे के नचिले भाग के चनिह तक न पहुँच जाए (लगभग 12 महीने की आयु पर) या फरि मध्य भाग के चनिह तक न पहुँच जाए (लगभग 2 से 3 वर्ष की आयु पर)। इसके बाद शिशु का मुँह सामने की दशिा में हो जबतक शिशु का कन्धा कन्धे के ऊपरी भाग के चनिह तक न पहुँच जाए (लगभग 4 साल की आयु पर)।

शिशु के इस सीमा तक पहुँचने तक इस शिशु प्रतबिन्ध का प्रयोग जारी रखें।

शिशु के मुँह सामने की दशिा की ओर तब तक न करे जबतक कि शिशु का कन्धा कन्धे के नचिले भाग के चनिह को पार न करे।

शिशुओं को समय से पहले सामने की ओर बैठाए जाने पर उन्हें गम्भीर चोट का खतरा होता है।

बूस्टर सीट को समय से पहले प्रयोग कए जाने पर शिशुओं को गम्भीर चोट का खतरा होता है।

जो शिशु इस प्रतबिन्ध के लए अनुकूल आयु से बड़े हो चुके हों, वे एक बड़े आकार के प्रतबिन्ध में सबसे अधिक सुरक्षित होते हैं

जसिकी इन-बलिट हार्नस या बूस्टर सीट हो और तब तक जब तक उनके कन्धे प्रतबिन्ध के कन्धे के ऊपरी भाग के चनिह तक न पहुँच जाए।

僅可後向安裝使用，直至嬰兒肩膀達到靠下的肩高標記（大約12個月大），或是達到中間肩高標記（大約2至3歲大）。然後您才能讓其乘坐前向安裝使用的座椅，直至其肩膀達到高位肩膀高度標記（大約4歲大）。

孩子應一直採用後向式坐姿，直至其達到後向式坐姿的上限。

孩子肩膀未超過靠下的肩高標記前，切勿採用前向式坐姿。

孩子若過早乘坐前向式汽車座椅，可能會對其造成嚴重的傷害。

急於讓孩子過早地乘坐墊高椅，可能會對其造成嚴重的傷害。

孩子因長大超出此汽車座椅的上限，最安全的做法便是採用更大且有內建式安全帶的汽車座椅，或是乘坐墊高椅，直至其肩膀達到汽車座椅靠上的肩高標記。

Chỉ được sử dụng ở vị trí hướng mặt về phía sau cho đến khi vai của bé cao tới vạch ghi ở dưới cùng (khoảng 12 tháng tuổi) hay tới vạch ghi độ cao ở giữa (khoảng 2 tuổi tới 3 tuổi). Sau đó được sử dụng hướng mặt về phía trước đến khi vai của em cao tới vạch ghi ở trên cùng (khoảng 4 tuổi).

Hãy tiếp tục sử dụng ghế em bé này đến khi em cao tới giới hạn này.

Không sử dụng hướng mặt về phía trước cho đến khi vai của em bé trên vạch ghi độ cao của vai ở dưới cùng.

Bé sơ sinh có nguy cơ bị chấn thương nghiêm trọng nếu hướng mặt về phía trước quá sớm.

Trẻ em có nguy cơ bị chấn thương nghiêm trọng đối sang ghế em bé (booster) quá sớm.

Các em nào lớn hơn ghế em bé được an toàn nhất là trong ghế em bé (restraint) lớn hơn với đai nịt gắn sẵn hoặc ghế trẻ em rộng hơn cho đến khi vai của em cao tới vạch ghi độ cao của vai ở trên cùng của ghế em bé.



INTRODUCTION

These instructions cover various configurations of this model. To determine if the feature is available on your child restraint refer to packaging. ISOFIX compatible connection is not available on all models.

No child restraint can guarantee absolute protection from injury in every crash. However, to ensure that your child gets all the protection designed into the restraint PLEASE READ AND FOLLOW THESE INSTRUCTIONS EXACTLY and use only Britax Safe-n-Sound recommended parts and accessories.

A child should not use this restraint in the forward facing mode until their neck muscles are able to support their head. However Britax recommends that you keep your child in a rearward facing restraint for as long as possible or until the appropriate shoulder height marker is reached.

Carefully read all the instructions for installation in this book. If in doubt about the method of installation, consult Britax Childcare or agent, or a child restraint fitter or, in New Zealand, to consult the agent for the vehicle.

To be used with a lap-sash or lap only seatbelt or ISOFIX low anchorages (if fitted) in the back of most cars with forward facing seats.

Regional Road Rules may prohibit the use of this restraint in the front seat of the car until the child is 4 years of age. Check your Regional Rules for exemptions.

Note: These instructions show the adjustable headrest with side wings, these instructions are also applicable to restraints with adjustable headrests without side wings.

Always store the instruction book in the pocket provided and tuck pocket under trim cover.

WHAT ARE ISOFIX LOW ANCHORAGES IN A VEHICLE?

If you purchased a model which is ISOFIX Compatible there will be straps fitted to each side of the lower part of the seat and stored at the upper side of the seat. Refer to page 24.

ISOFIX low anchorages are fixed, standardised anchoring points for securely installing an ISOFIX compatible child restraint in a vehicle with ISOFIX low anchorages. They are an alternative method of installing the child restraint without using car's seatbelt.

It has now become an international standard for vehicles. This anchoring technology minimises installation mistakes by optimising the protective effect of the connection between vehicle and ISOFIX compatible child restraint.



PAGE

- 14 INTRODUCTION
- 16 WARNINGS
- 18 SHOULDER HEIGHT MARKERS
A GROWING CHILD
- 20 SHOULDER HEIGHT MARKERS
- 21 SHOULDER HEIGHT MARKERS
THE NEXT STEP
- 22 INSTALLATION METHOD
- 23 SPECIAL FEATURES:
REARWARD FACING
- 26 SUITABLE FOR USE
- 27 HOW TO INSTALL
- 28 HOW TO INSTALL USING
SEATBELT
- 36 HOW TO INSTALL USING
ISOFLEX CONNECTORS
- 42 HOW TO USE
- 50 HOW TO REMOVE
- 53 SPECIAL FEATURES: FORWARD-
FACING
- 56 SUITABLE FOR USE
- 57 HOW TO SETUP
- 60 HOW TO INSTALL USING
SEATBELT
- 63 HOW TO INSTALL USING ISOFLEX
CONNECTORS
- 67 HOW TO USE
- 72 HOW TO REMOVE
- 74 HOW TO INSTALL IN AN AIRCRAFT
- 77 CARE & MAINTENANCE
- 86 ACCESSORIES
- 89 INSTALLATION OF CAR UPPER
ANCHORAGE POINT
- 93 TRAVELLING TIPS
- 94 IN CASE OF ACCIDENT



WARNINGS

- Fit the restraint firmly to the car seat.
- Fit the harness firmly to the child.
- A loose restraint or harness is dangerous.
- Supervision of children is needed because they may be able to undo the buckles and adjusters.
- Use the restraint exactly as shown in the instructions.
- **DO NOT LEAVE CHILDREN UNATTENDED IN THE CAR.**
- Do not alter or modify this restraint.
- Repairs must only be done by the manufacturer or agent.
- Do not allow the restraint to come into contact with polishes, oils, bleach and other chemicals.
- Destroy the restraint if it has been in a severe crash, even if no damage is visible. See page 94.
- **DO NOT USE THIS RESTRAINT WITHOUT THE COVER.**
- Always secure the loose end of the top tether strap. Do not use the child restraint where this strap may fall into a split in the seat back or off the side of the seat.
- **ALWAYS ATTACH HOOK AND REMOVE SLACK.**
- To ensure infant's back is evenly supported, do not put more than one nappy on the baby and make sure the nappy is not thickly folded at the back.
- **DO NOT USE A REAR-FACING CHILD RESTRAINT WHERE AN AIRBAG IS FITTED IN FRONT OF THE SEATING POSITION.**
- Do not harness an infant wrapped in a blanket or swaddled. Any blanket or wrap must only be placed over the harness and infant.



IMPORTANT :

NON ISOFIX COMPATIBLE: FOR INSTALLATION WITH SEATBELT ONLY
TO BE USED WITH LAP-SASH OR LAP ONLY SEATBELTS IN THE BACK OF MOST CARS WITH FORWARD FACING SEATS.

- Without ISOFIX compatible connectors; This child restraint is not approved for use with any connectors that connect to the car's ISOFIX low anchorages.

ISOFIX COMPATIBLE: FOR INSTALLATION WITH ISOFLEX CONNECTORS

- TO BE USED WITH A LAP-SASH OR LAP-ONLY SEATBELT OR ISOFIX LOW ANCHORAGES IN THE BACK OF MOST CARS WITH FORWARD FACING SEATS.
- **Do not attach the lower attachment connectors of two separate child restraints to the same ISOFIX low anchorages in your car.**
- **Always attach the top tether strap to the child restraint upper anchorage in your car before each journey.**
- Child restraint lower attachment connectors and the ISOFIX low anchorages in your car are designed to withstand only those loads imposed by a correctly fitted child restraint.

GENERAL

- Regularly check the restraint components, straps and other fitments for correct function and condition. If faulty, cease using and seek repair by Britax.
- IF AN AIRBAG IS FITTED IN THE SEATING POSITION WHERE THE CHILD RESTRAINT IS TO BE FITTED, FOLLOW THE VEHICLE MANUFACTURERS WARNINGS AND INSTRUCTIONS.
- Protect all webbing from abrasion and cutting by sharp corners and edges.
- The restraint should not be purchased or sold as a second hand item. It is recommended not to use child restraints older than 10 years as the protection in an accident may be reduced.
- THIS RESTRAINT IS NOT SUITABLE FOR USE WHERE THE TOP TETHER STRAP MAY FALL INTO A SPLIT IN THE SEAT BACK OR OFF THE SIDE OF THE SEAT.
- Seatbelt extenders are not recommended to be used if the seatbelt is not long enough to secure the child restraint. If seatbelts are too short then seek advice from a child restraint fitter and consider their recommendations before using a seatbelt extender. If you use a seatbelt extender then ensure that the seatbelt buckle does not enter the rearward or forward facing belt paths.
- THIS RESTRAINT MUST BE ATTACHED TO A CHILD RESTRAINT UPPER ANCHORAGE POINT IN THE CAR. REFER TO CAR OWNER'S HANDBOOK FOR LOCATION OF UPPER ANCHORAGE POINTS. REFER TO A CHILD RESTRAINT FITTING STATION IF NO UPPER ANCHORAGE POINTS ARE IN THE MOTOR CAR. Refer to pages 89 to 92.

SHOULDER HEIGHT MARKERS A GROWING CHILD

This restraint must remain rear facing until the child reaches the lower shoulder height marker (approx. 12 months old).

Once the child reaches the lower shoulder height marker the restraint can either;

- Remain rear facing until the middle shoulder height marker is reached, or
- Change the mode to forward facing until the upper shoulder height marker is reached (approx. 2 to 3 years).

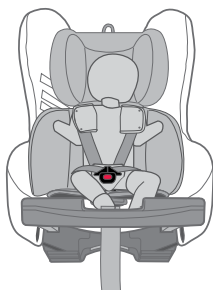
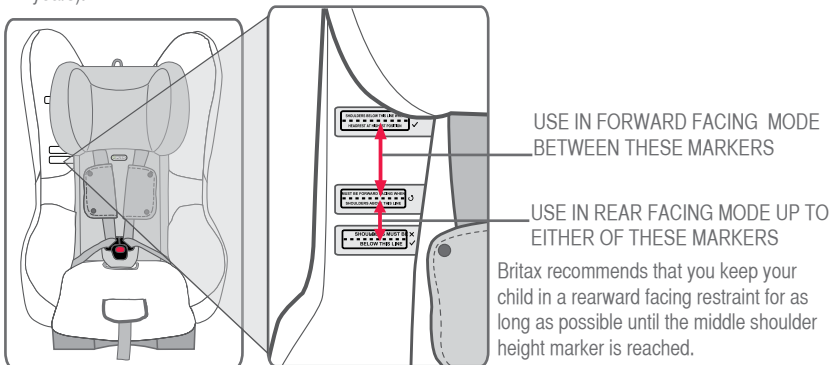

Rearward Facing

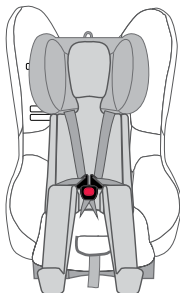

Forward Facing

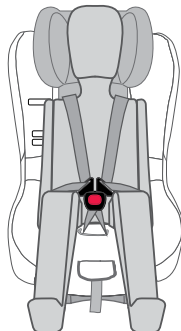

Forward Facing

SHOULDER HEIGHT MARKERS A GROWING CHILD

Newborn (Rearward-Facing)

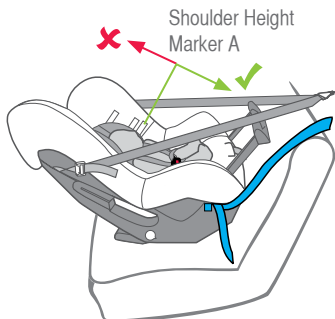

Older baby (Rearward-Facing)

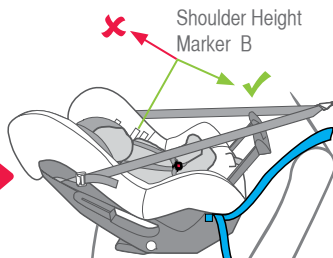

Turn to forward-facing when the child's shoulders are between the lower marker A and middle marker B shoulder height markers.

Child Use (Forward-Facing)

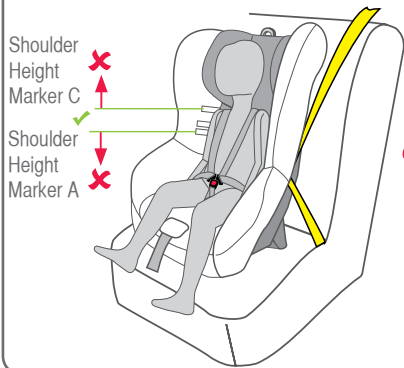

Move to the next form of child restraint when the child's shoulders reach the upper shoulder height marker.

SHOULDER HEIGHT MARKERS

! IMPORTANT: Follow this advice.

The child restraint is unsuitable for the occupant when the shoulders are above the upper height marker label. The child needs to be moved into the next form of child restraint.

Marker A: LOWER SHOULDER HEIGHT MARKER

When the child's shoulders reach the lower marker, the child restraint **may** be turned to face towards the front of the vehicle or move the child to another forward facing seat with in built harness. At least 12 months of age. Britax recommends to maintain rearward facing for as long as possible until the shoulders reach marker B.

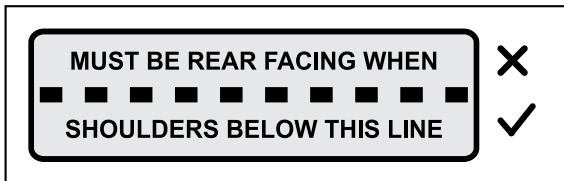

Marker B: MIDDLE SHOULDER HEIGHT MARKER

When the child's shoulders reach this marker, the seat **must** be moved into forward facing mode. Approximately 2 to 3 years of age.

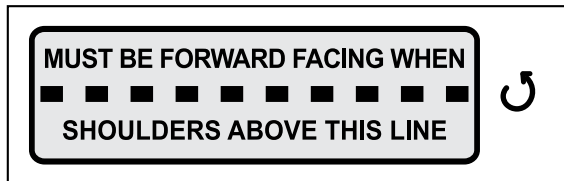

Marker C: UPPER SHOULDER HEIGHT MARKER

When the child's shoulders reach this upper marker, the child is now too big for the child restraint. It is now time to move to the next child restraint. Approximately 4 years of age.

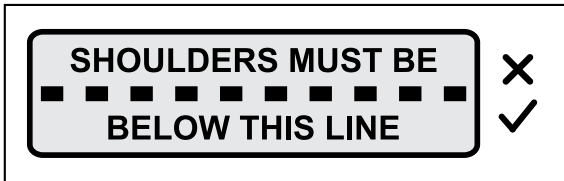

SHOULDER HEIGHT MARKERS AND THE NEXT STEP

Next type of restraint that can be used in the car for your child.

When your child has outgrown this seat, you can use:

- A convertible booster seat with integrated harness until approximately 4 years old and then as a booster seat with vehicle lap-sash seatbelt or seatbelt and compatible child harness until approx. 6 to 8 years of age.

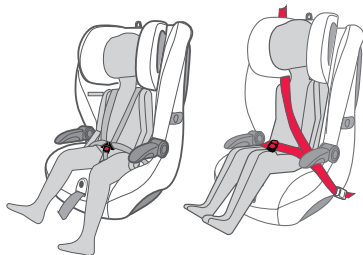

- Or you can use a dedicated booster seat with vehicle lap-sash seatbelt or seatbelt and compatible child harness until 6 to 8 years of age (eg: Safe-n-Sound Hi-Liner) or until 8 to 10 years of age (eg. Safe-n-Sound Encore 10).

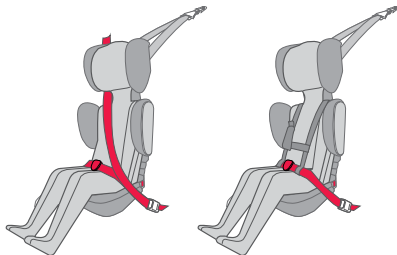

- Or a harnessed child restraint suitable for children approximately 6 months to 8 years old (eg: Safe-n-Sound Maxi Guard)

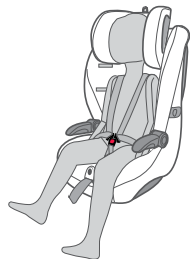



INSTALLATION METHOD

If you have purchased a restraint with ISOFIX lower anchorage straps then the restraint may be installed by either the ISOFIX low anchorages or the seatbelt. If there are no ISOFIX low anchorages straps then the restraint can only be fitted with the seatbelt.

Consult the car owner's handbook for location of top tether anchorage points.

If there is no child restraint anchor fitting or child restraint anchor point refer to pages 83 to 86 for the installation of the anchor fitting as well as the use of extension straps.

An anchor fitting is required to attach the top tether strap to fully install the restraint to the vehicle. The top tether strap must be used with this child restraint when used.

Select a seating position with a child restraint anchor fitting directly behind the seating position.

Determine if the vehicle ISOFIX Low Anchorages or Seatbelt will be used to secure the restraint installation. The ISOFLEX connectors will need to be deployed from their storage location prior to adjusting the seat recline angle to rearward facing mode.

SEATBELT OR ISOFIX COMPATIBLE

If not fitted with ISOFIX compatible straps this seat is suitable for fitting with seatbelt and top tether strap.

If fitted with ISOFIX compatible straps the installation may be either seatbelt and top tether strap or ISOFLEX Connectors and top tether strap.

SEAT BELT WITH TOP TETHER STRAP

Use your vehicle seat belt and top tether strap to install this seat. Follow the directions outlined:

For Rearward Facing Use - Refer to page 29 to 35

For Forward Facing Use - Refer to page 59 to 62

ISOFLEX (if fitted) WITH TOP TETHER STRAP

Use your vehicles ISOFIX low anchorage points and top tether strap to install this seat. Follow the directions outlined:

For Rearward Facing Use - Refer to page 36 to 41

For Forward Facing Use - Refer to page 63 to 65

SPECIAL FEATURES: REARWARD FACING

Shoulder Height Markers
may be hidden under
headrest in lowest position.

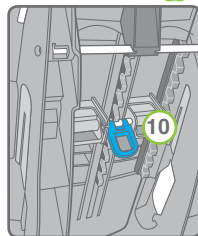
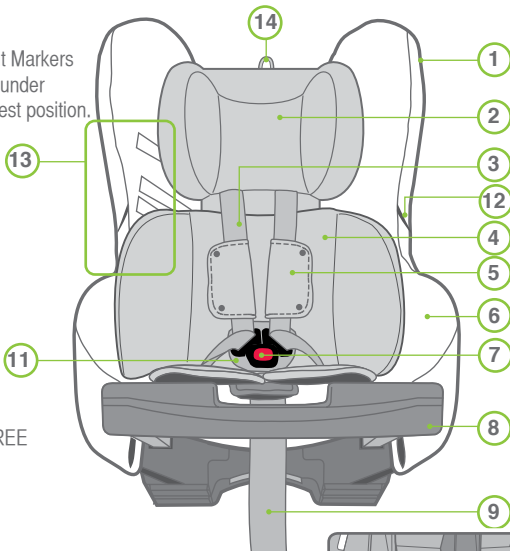
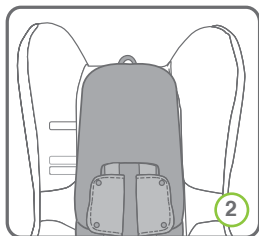

(Harness strap not shown)

1. Instruction Storage Pocket (on side)
2. Adjustable Headrest with or without side wings incorporating HASSLE FREE HARNESS™ (see note below)
3. Fully adjustable 6 point Harness
4. Padded insert (if fitted)
(may vary in style)
5. Shoulder Pads (if fitted)
6. Padded Cover for comfort
7. Release Buckle (Red button)
8. Stabilising Bar for Rearward Facing mode
9. Harness Adjustment Strap
10. Headrest Adjuster Latch
11. EZ Buckle System
12. Harness Tongue Holders (where fitted)
13. Shoulder Height Markers
14. Headrest Loop

Note: These instructions show the adjustable headrest with side wings, but these instructions are also applicable to restraints with an adjustable headrests without side wings.

SPECIAL FEATURES: REARWARD FACING

SEATBELT ONLY VERSION

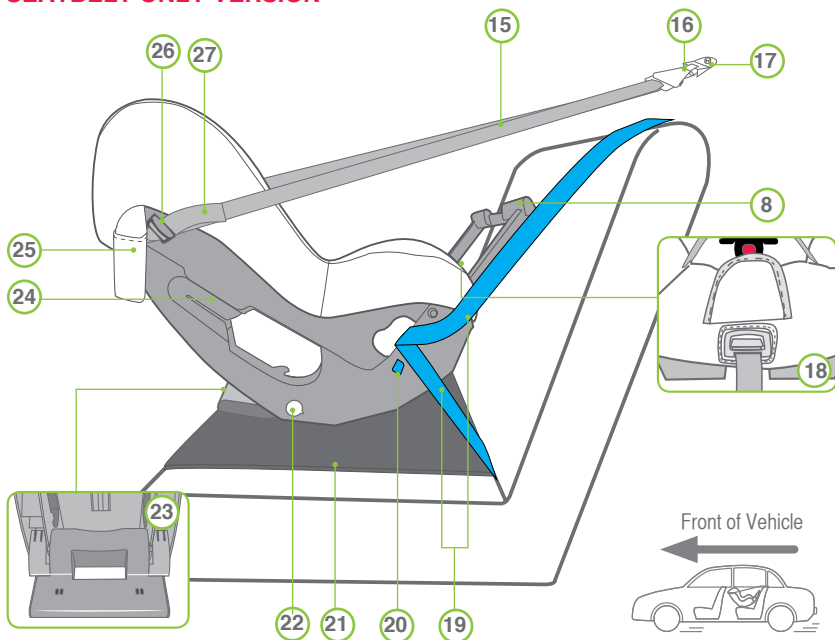

- | | |
|--|--|
| 15. Adjustable Top Tether Strap | 21. Messy Mat™ (if supplied) |
| 16. Attachment Clip | 22. Recline Position Indicator |
| 17. Vehicle's Anchor Fitting | 23. Recline Foot in Rearward Facing mode |
| 18. Harness Adjustment Lever (under trim flap) | 24. Upper Lock-off (Forward Facing only) |
| 19. Vehicle's seatbelt | 25. Top Tether Storage Pocket |
| 20. Blue REARWARD FACING BELT PATH label | 26. Top Tether Adjuster |
| | 27. Top Tether Adjustment Strap |

SPECIAL FEATURES: REARWARD FACING

ISOFIX COMPATIBLE VERSION

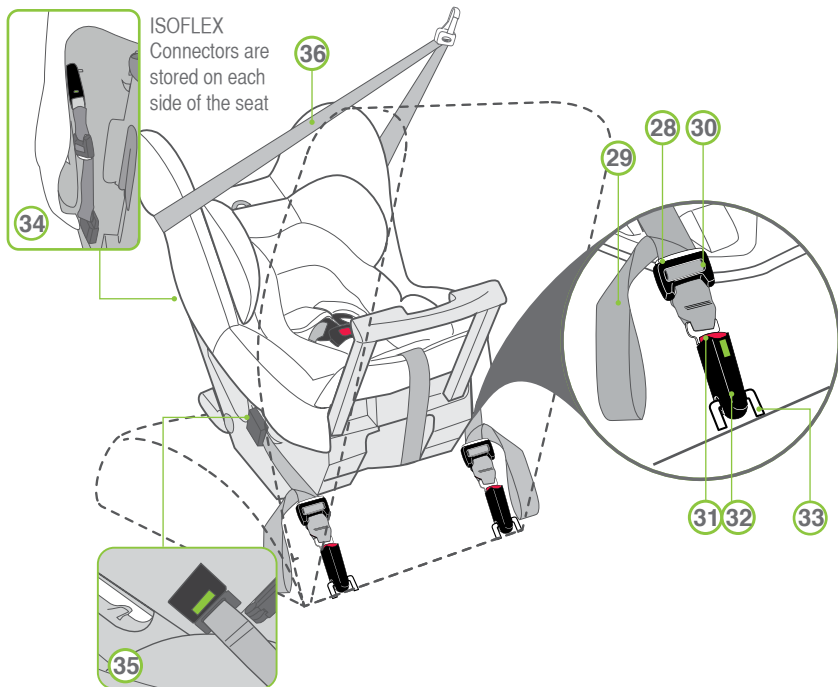

ISOFLEX CONNECTORS (IF FITTED)

28. ISOFLEX Strap Adjuster Button

29. ISOFLEX Strap

30. ISOFLEX Strap Adjuster

31. ISOFLEX Connector Release Button

32. ISOFLEX Connector

33. Vehicle's ISOFIX low anchorage

34. ISOFLEX storage location

35. Tension Indicator (Green when activated)

36. Top tether

SUITABLE FOR USE

Continue to use this child restraint in this rear facing mode until the child's shoulders reach the limit of the lower or middle shoulder height marker before turning the seat to face forward. A younger child's neck muscles may be unable to support their head thus the child should remain rear facing until the neck muscles become stronger.

The purchaser should check the measurements between the front of the seat back of the rear seat and all front seats in the car in which the child restraint is intended to be used, to ensure that the space is sufficient. If you have the restraint check it fits in your car. The length may be longer when the headrest is raised when rear facing.

Regional Road Rules may prohibit the use of this restraint in the front seat until the child is 4 years of age. Check your Regional Road Rules for exemptions.



WARNINGS

DO NOT USE RESTRAINT IN REARWARD FACING MODE WITHOUT STABILISING BAR FULLY EXTENDED.

Do not use the restraint without the top tether strap correctly attached.

DO NOT USE A REAR FACING CHILD RESTRAINT WHERE AN AIRBAG IS FITTED IN FRONT OF THE SEATING POSITION.

Do not use on any vehicle seat which faces sideways or rearwards.

Never leave babies or toddlers in a stationary car in the sun because of the risk of heat exhaustion. Ensure babies and toddlers have adequate ventilation and are shaded from direct sunlight through side or rear windows.

CHILD RESTRAINT UPPER ANCHORAGE FITTING

To use this child restraint, the car will need a child restraint upper anchorage fitting in the seating position that you intend to use. Refer to the car owner's handbook.

The upper anchorage fitting is required for attaching the top tether in both rear facing mode and forward facing mode covered later in these instructions.

If no upper anchorage fitting is provided then you will need to install an upper anchorage fitting. Refer to pages 83 to 86.

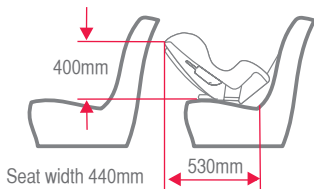

Do not allow the front seat to alter the installed angle of the restraint. It is permissible to allow the restraint to touch the front vehicle seat.

HOW TO INSTALL

PREPARING FOR INSTALLING INTO VEHICLE - REARWARD FACING

The restraint is normally packaged in the fully upright, forward facing mode, if you need to use it rearward facing you must first fully recline the restraint, and convert it to rearward facing mode as shown below.

If upper anchorage strap is folded up for storage undo storage strap to lengthen. Fully press adjuster button (A) while pulling upper anchorage strap (B) to lengthen.

Fully press Adjuster Button (A) while pulling Upper Anchorage Strap (B) to lengthen.

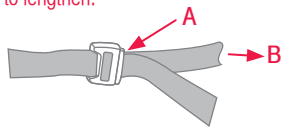

CONVERT TO REARWARD FACING MODE

A. To fully recline the restraint, move recline foot by pulling the recline foot handle and rotating to the rearward facing position (refer to label on the side of the restraint) until the handle locks into position. Ensure recline foot locks into position.

Rotate recline foot to rearward facing position

Recline position indicator

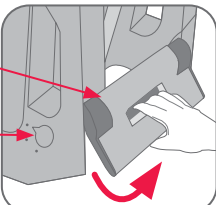

Pull Recline Foot Handle and rotate to adjust

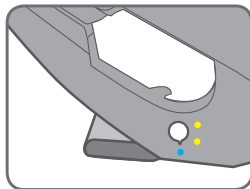
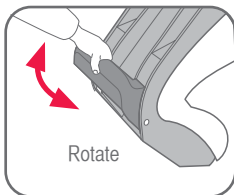
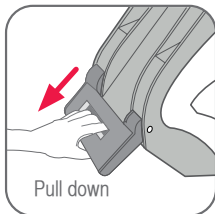

HOW TO INSTALL

- B. Lift the flap at the end of the seat to access the stabilising bar, pull out stabilising bar and then gently push bar forward until you hear a click. Stabilising bar is now latched in place. Refit the cover.

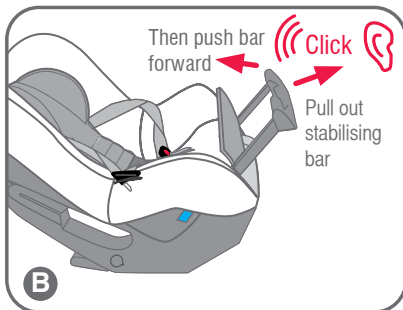
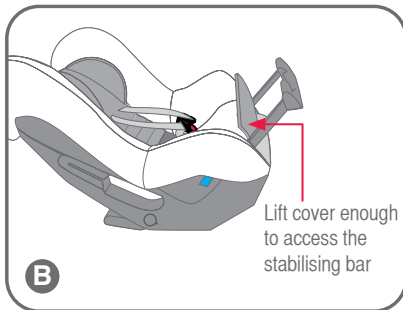

HOW TO INSTALL

**INSTALLING INTO A VEHICLE
WITH SEATBELT. (REARWARD
FACING)**

- A. Position restraint rearward facing in the chosen seating position in the car where a child restraint anchor fitting is installed.
- B. Undo the buckle and place buckle tongues in the Harness Tongue Holders on each side of the cover.
- C. Remove padded insert (if fitted), and gently lift headrest trim end, then pull backwards the centre panel flap, with the comfort pad from the inner seat of trim.

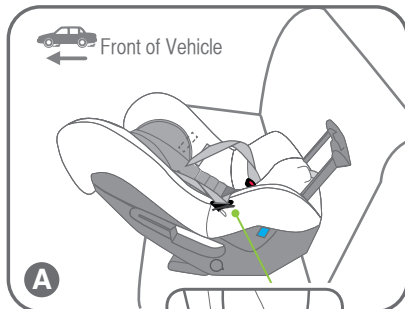

Harness
Tongue
Holders

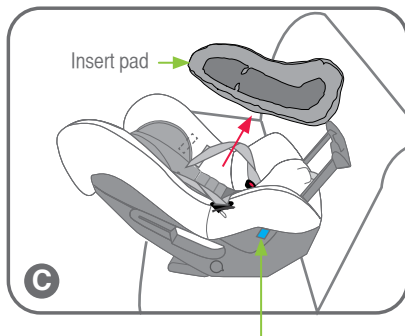

blue **REARWARD FACING**
BELT PATH label

HOW TO INSTALL

- D. Fully lengthen seatbelt and through the blue **REARWARD FACING BELT PATH** opening feed the seatbelt between the restraint cover and the restraint body through seatbelt slots in restraint.

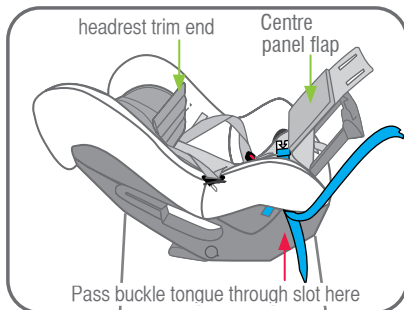

- E. Engage seatbelt buckle and tongue. Push down on the seat (by hand), whilst pulling the sash belt firmly to tighten the seatbelt. This will make the lap belt very tight across the restraint. Whilst holding the seatbelt tension, ensure to remove all slack from lap part of seatbelt by pulling sash belt. For retractor seatbelts, allow excess belt to feed back into retractor.

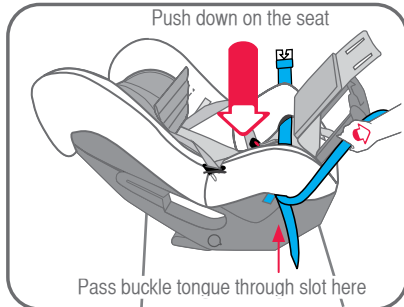

NOTE: Seatbelt buckle and tongue must not rest between restraint cover and restraint. If seatbelt buckle is adjustable, adjust buckle as low as possible away from the restraint.

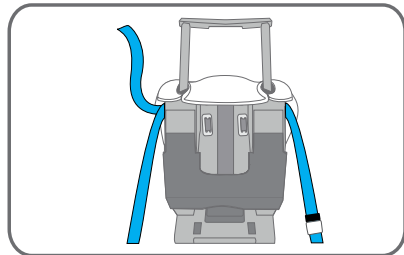

HOW TO INSTALL

- F. Replace the centre panel flap, ensure the harness buckle is through the panel, and connect the hook and loop to retain the cover. Replace the padded insert (if supplied). Do not use padded insert if the child's shoulders reach the lower shoulder height marker or the child no longer fits the insert. See page 43 for advice on positioning the shoulder straps.

NOTE: Seatbelt extenders should not be used if the seatbelt is not long enough to secure the child restraint. If they are used then the buckle must not enter the seating zone.

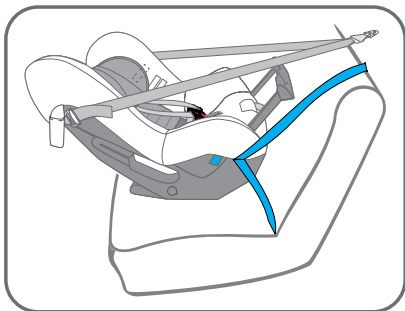
**PADDED INSERT**

Your restraint will be supplied with either a full or half padded insert.

The padded insert may be used until the child's shoulders reach the lower shoulder height marker, or the padded insert causes discomfort.

The padded insert's are not required for forward facing but may be used to lift the child if their shoulders are below the lower shoulder height marker.

Half padded insert



Full padded insert



HOW TO INSTALL

- G. Fit the attachment clip to the car's anchor fitting as shown right. Make sure to remove as many twists as possible from the upper anchorage strap.
- H. Tighten top tether strap by pulling adjustment strap to remove slack, leave the strap slack on the side the baby will be placed into the seat from. Any slack will be removed once the baby has been harnessed into the seat.
- I. Remove the slack from the adjustable top tether strap by pulling adjustment strap (3). After the baby is fitted in to the harness, remove all slack in the top tether strap and roll up excess strap and place in the pocket provided.
- Do not tighten the top tether strap such that the restraint is lifted up. Remove slack only.

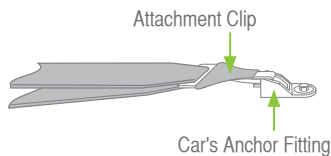

Fully press Adjuster Button (1) while pulling Upper Anchorage Strap (2) to lengthen.

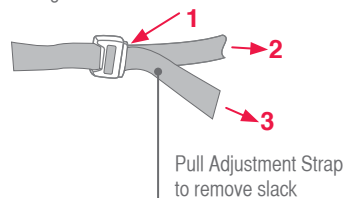

Roll up excess strap and store in the pocket attached to the cover.



CAUTION:

CHILDREN CAN BE INJURED OR RESTRAINTS AND TOP TETHER STRAP DAMAGED BY UNSECURED CARGO IN A COLLISION. SECURE OR REMOVE HAZARDOUS CARGO BEFORE USING THIS CHILD RESTRAINT.

HOW TO INSTALL

FITTING SUMMARY

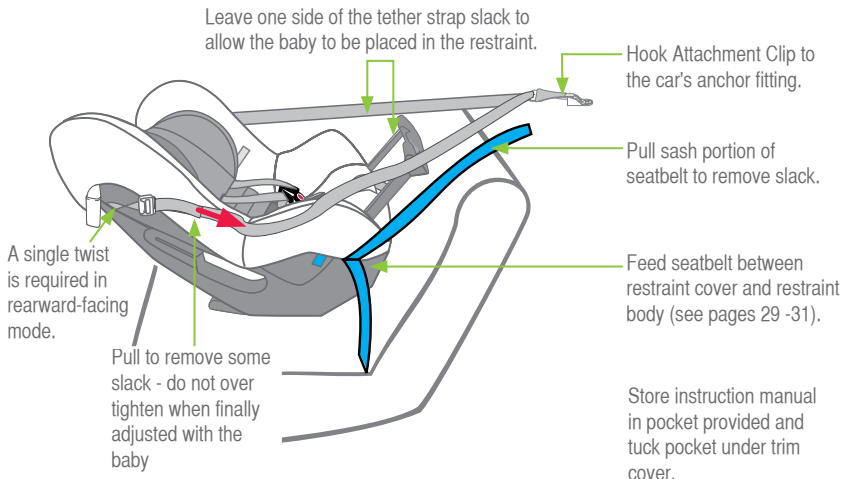

WARNINGS

**DO NOT USE RESTRAINT IN REARWARD FACING MODE WITHOUT STABILISING BAR FULLY EXTENDED.
THE TOP TETHER STRAP MUST ALWAYS BE FITTED WHEN THE CHILD RESTRAINT IS USED IN A VEHICLE.
ALWAYS ATTACH THE HOOK AND REMOVE THE SLACK.**

HOW TO INSTALL

IMPORTANT: If using an Extension Strap, positioning the attachment clip above the child may lead to injury in an accident therefore make sure that the attachment clip is not positioned in front of the vehicle seat. Use a shorter extension strap or no extension strap.

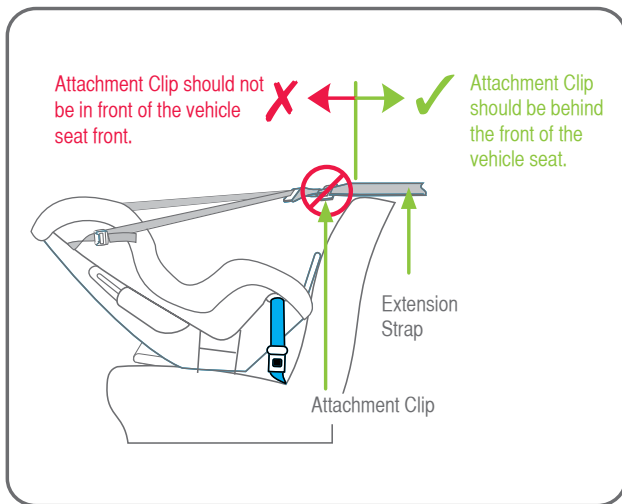

HOW TO INSTALL

ANGULAR ADJUSTMENT OF RESTRAINT

Some vehicle seats have more rearward slope than others. If the angle of the seat causes the baby to be too upright for comfort, the angle may be altered by placing a firm packing between the seat and the underside of the base. Packing can be a firmly rolled up towel.

If the car's seat is flat then some packing may be required at the front edge of the base to achieve the recline angle.

Do not remove all of the rearward slope by over packing. Always leave a rearward slope angle of approximately 10 to 15 degrees as shown

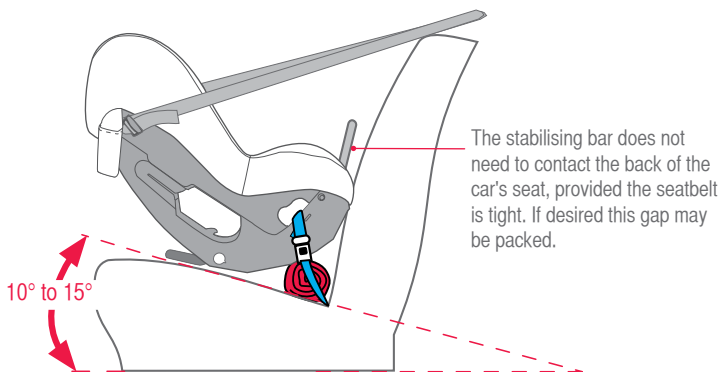

HOW TO INSTALL USING ISOFLEX CONNECTORS

INSTALLING THE RESTRAINT INTO THE CAR (USING ISOFLEX CONNECTORS IF FITTED TO THE CHILD RESTRAINT)

- A. Setup the seat for rear-facing mode by extending the stabilising bar as described on page 27 and 28.
- B. Locate the ISOFIX Low Anchorages in the vehicle rear seat. The location may be identified by one of the following symbols, or the anchorage bars may be visible.



If you cannot locate the ISOFIX bars, check your vehicle owners manual.

ISOFIX low anchors in the vehicle rear seat

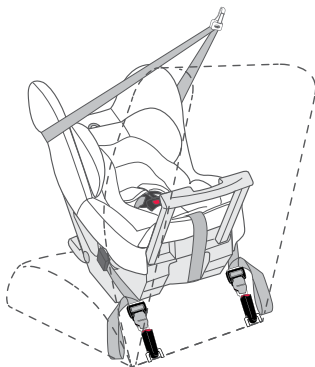
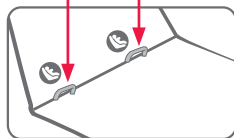

HOW TO INSTALL USING ISOFLEX CONNECTORS

INSTALLING INTO THE CAR USING ISOFLEX AND TOP TETHER CONNECTORS IF FITTED

- C. With the restraint upright, remove both ISOFLEX connectors from storage on the rear of the restraint by the connector as shown.
- D. Recline instructions are shown on page 27.
- E. Press and hold the ISOFLEX adjuster release button and pull the connector strap to fully lengthen. Repeat for the other connector.
- F. Place the restraint in the desired location on the vehicle seat between the two ISOFIX low anchorages with the child seat against the vehicle seat back as shown.

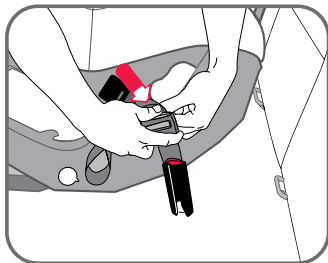

HOW TO INSTALL USING ISOFLEX CONNECTORS

- G. The stabilising bar need not be in contact with the vehicle seat back but must be extended and latched. Engage the ISOFLEX connectors into each ISOFIX low anchorage. A click may be felt and a green indicator will show on the top of the ISOFLEX connector when it has engaged. Pull each strap to ensure both lower anchorage connectors are engaged. Pull the adjusting strap to remove most of the slack on each side but do not tighten.

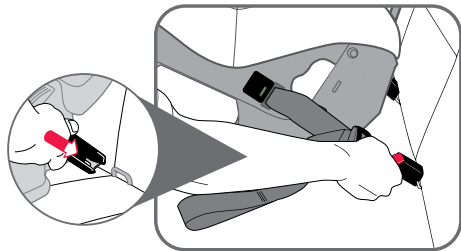

Push here

- H. Push downwards on the armrest of the seat to compress the side of the seat into the vehicle seat. Whilst pushing into the seat, pull on adjuster strap to remove all slack and tighten the ISOFLEX strap. Repeat for the adjuster strap on the other side of the restraint. The two tension indicators will show green indicating minimum tension has been applied.

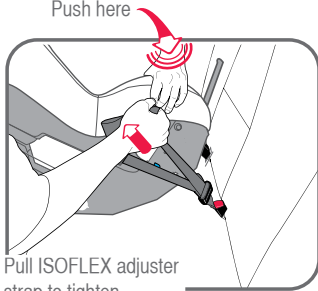

Pull ISOFLEX adjuster strap to tighten

IMPORTANT:

Do not attach the lower attachment connectors of two separate child restraints to the same ISOFIX low anchorages in your car. Always attach the top tether strap to the child restraint upper anchorage in your car.

Child restraint lower attachment connectors and the ISOFIX low anchorages in your car are designed to withstand only those loads imposed by a correctly fitted child restraint.

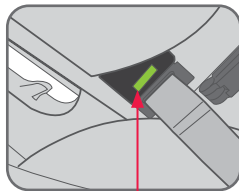

Tension indicator

HOW TO INSTALL USING ISOFLEX CONNECTORS

Pull to remove some slack - do not over tighten when finally adjusted with the baby

A single twist is required in rearward facing mode.

Do not use this slot for rearward facing installation

Leave one side of the tether strap slack

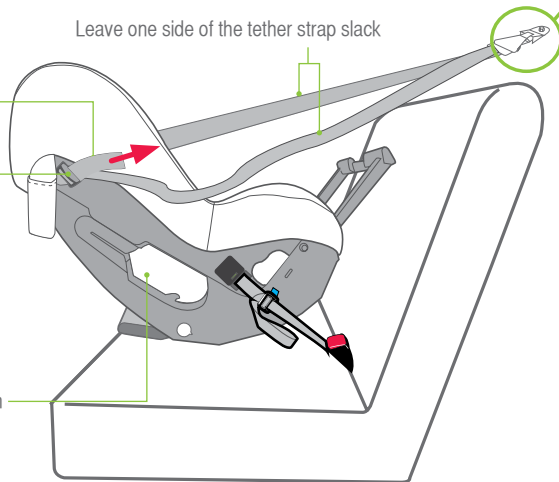
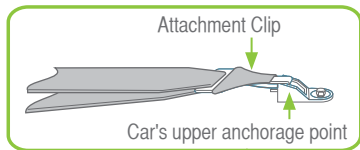

WARNINGS

ISOFIX Compatible version shown.

DO NOT USE RESTRAINT IN REARWARD FACING MODE WITHOUT STABILISING BAR FULLY EXTENDED.
THE TOP TETHER STRAP MUST ALWAYS BE FITTED WHEN THE CHILD RESTRAINT IS USED IN A VEHICLE.
ALWAYS ATTACH THE HOOK AND REMOVE THE SLACK.

HOW TO INSTALL USING ISOFLEX CONNECTORS

If the car's upper anchorage fitting is behind the vehicle seat back you may need to use an extension strap as part of the top tether installation.

IMPORTANT: If using an Extension Strap, positioning the attachment clip above the child may lead to injury in an accident therefore make sure that the attachment clip is not positioned in front of the vehicle seat. Use a shorter extension strap or no extension strap.

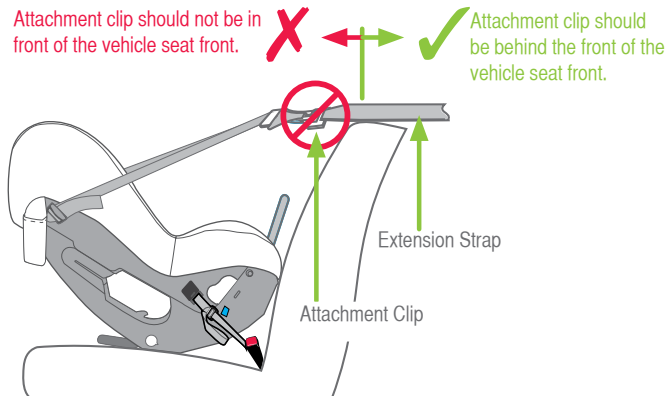

It is normal to have some sideways movement if the headrest end is pushed sideways. A firmer fit can be achieved by applying more force to the ISOFLEX straps. If the tether strap is over tightened then the angle of the seat may be affected.



IMPORTANT :

The Top tether strap must be fitted at all times when the baby is in the car when using either the seatbelt or the ISOFLEX connectors.

Always secure the loose end of the top tether strap to prevent it hanging out of the car or being accessible by the child.

THIS RESTRAINT IS NOT SUITABLE FOR USE WHERE THE TOP TETHER STRAP MAY FALL INTO A SPLIT IN THE SEAT BACK OR OFF THE SIDE OF THE SEAT.

ALWAYS ATTACH TOP TETHER HOOK AND REMOVE SLACK IN THE TOP TETHER STRAP.

HOW TO INSTALL USING ISOFLEX CONNECTORS

ANGULAR ADJUSTMENT OF RESTRAINT

Some vehicle seats have more rearward slope than others. If the angle of the seat causes the baby to be too upright for comfort, the angle may be altered by placing a firm packing between the seat and the underside of the base. Packing can be a firmly rolled up towel.

Do not remove all of the rearward slope by over packing. Always leave a rearward slope angle of approximately 10 to 15 degrees as shown

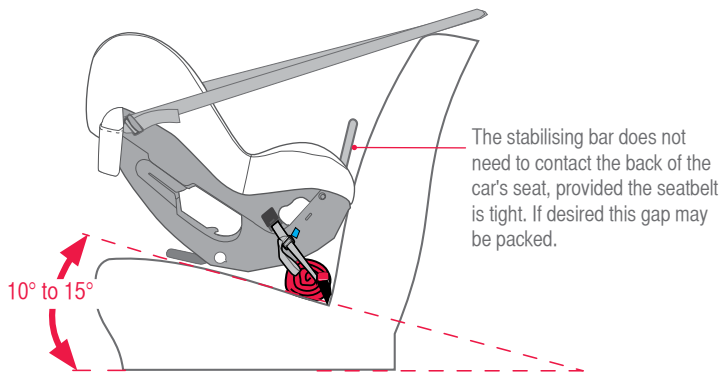

HOW TO USE

ADJUSTING HASSLE FREE HARNESS™ HEADREST (with or without side wings)

Correct fitment of the harness is very important as it restrains the child in the restraint. The headrest must be in the correct position & the harness must fit firmly around upper torso of the child and be positioned so as to leave the child's arms and legs free.

In rearward facing mode the headrest must be in the position where the **top** of the shoulder strap slots are nearest to the child's shoulders, but not lower than the child's shoulders. Instructions for adjusting the headrest is on the next page. If your child has reached the lower shoulder height marker then the restraint may be converted to forward facing mode (Refer to Forward Facing section from page 29).

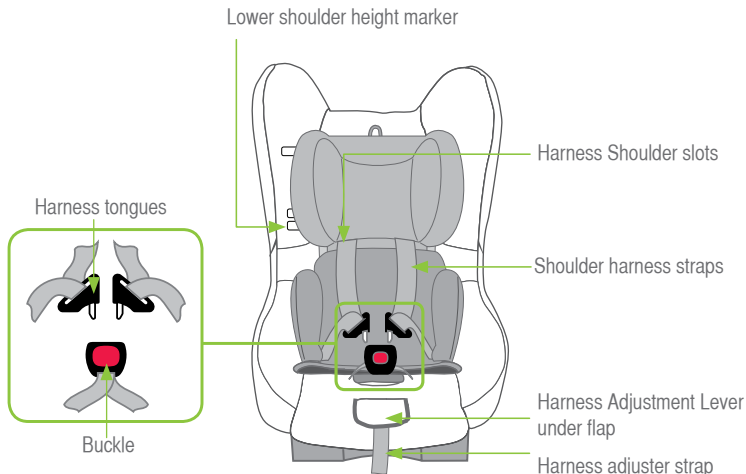

HOW TO USE

1. The shoulder straps must be positioned in slots which are nearest to the child's shoulders, but not lower than the child's shoulders. There is only one set of slots so the seat will always have the shoulder straps in place once the headrest is positioned correctly.
2. The padded insert may be used for smaller babies in rearward facing mode.
3. Discontinue the use of the padded insert if there is insufficient room for the child or shoulders have reached the lower shoulder height marker.

When positioning baby into the restraint make sure baby's back is fully supported onto the flat section and the baby's nappy area (bottom) is resting in the bottom curvature as shown. It is recommended that bulky nappies are not used when baby is travelling in the restraint as they can cause incorrect positioning of the baby's back in the restraint.

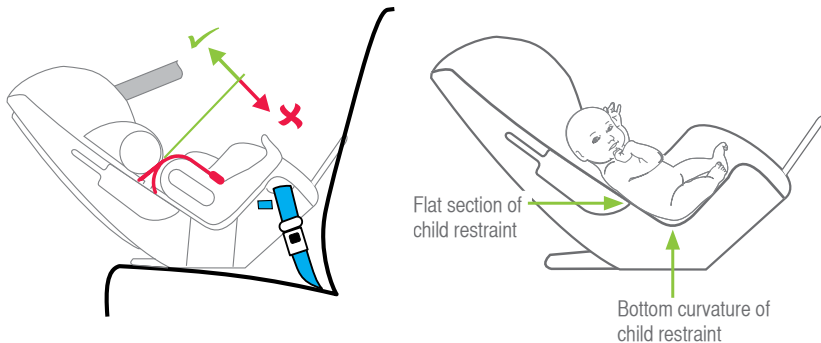

HOW TO USE

HOW TO ADJUST HEADREST & HASSLE FREE HARNESS™

- A. Loosen the harness straps before adjusting the headrest.
- B. To adjust the headrest, pull on the latch on the back of the restraint and pull up or down to position the top of the shoulder strap slot above the child's shoulders. Release the latch to lock the headrest in position. Pull headrest upwards to check it is locked in position.
- C. This method can be used when the child restraint is installed in the vehicle in rearward facing position. Small adjustments may be possible with the child still in the seat.

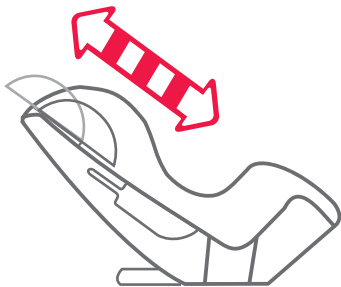
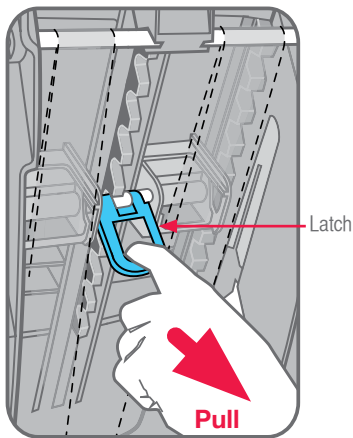

IMPORTANT :

Ensure harness and headrest are positioned so that the shoulder straps are just above or inline with the child's shoulders but not lower. The bottom of the headrest side wings will usually be just above the infant's shoulders.

It is not necessary to remove the harness straps to adjust the headrest position. Refer to Care and Maintenance for cover removal page 79.

HOW TO USE

ALTERNATIVE HEADREST ADJUSTMENT METHOD.

HOW TO ADJUST THE HEADREST & *HASSLE FREE HARNESS™* -
Installed in vehicle

When the child restraint is installed in to the vehicle, the headrest and shoulder strap slot height can be adjusted without removing the seatbelt from the restraint by using this method.

- Loosen the harness straps before adjusting the headrest.
- Pull the top of the padded insert forward to expose the "PUSH" label at the centre of the headrest
- Place finger on the "PUSH" button, press in towards restraint, lift the headrest loop to adjust upward or downward.

Be sure to use the 'push' button label as a guide. Press the 'push' button (approx. 10mm) into the recess behind the cover. Once released check the headrest has latched by attempting to lift the headrest using the headrest loop.

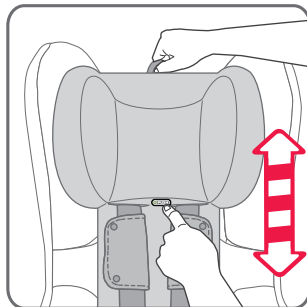
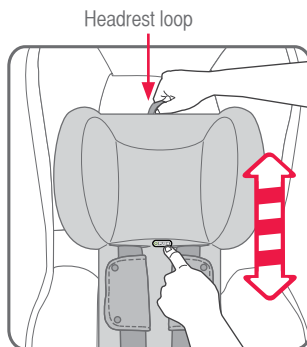
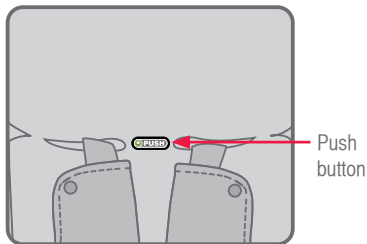

HOW TO USE

PLACING CHILD INTO RESTRAINT

- Ensure the headrest and shoulder straps are adjusted to the correct height for your child (see page 43).
- Slacken the top tether strap if not already slack and allow the straps to fall to the sides of the restraint for easy access to the child.
- Loosen shoulder straps by pressing the harness adjuster and pull both shoulder straps evenly. Pull out the desired amount of slack.
- Place the two harness tongues into the Buckle Tongue Holder (if fitted).
With the EZ buckle system the harness buckle will flip towards the harness adjuster for easier fitment next time you put the infant in the carrier.
- Place baby into child restraint lying on its back so that the buckle is between the baby's legs. Ensure that baby's arms and legs are free. Make sure baby is dressed to allow the Harness Buckle to be pulled up between baby's legs e.g. a jump suit.

NOTE: The headrest should be adjusted so that the wings on the headrest or shoulder strap slots are just above the shoulders but not below the shoulders.

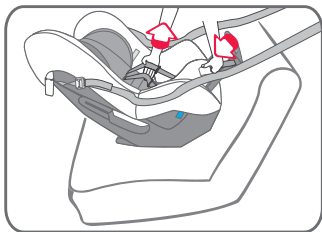

CAUTION:

Do not harness an infant wrapped in a blanket or swaddled as this increases the risk of ejection and injury or death in a crash. The harness needs to fit firmly to the baby, any blanket or other covering may be placed over the harness after the harness is adjusted. Arms and legs must be free and not bound or wrapped together. The legs must sit on each side of the crotch strap.



IMPORTANT :

Always adjust the height of the headrest thus the shoulder straps as the child grows.

HOW TO USE

- F. Fit either harness tongue into the harness buckle followed by the other tongue. A click is heard when the last tongue is fully engaged.
Should the second tongue not engage - press the red button and reinsert the tongues. Ensure secure engagement by pulling harness straps. If the harness buckle does not engage correctly then it may require cleaning or seek replacement - refer to page 79. **The buckle tongues are fully engaged when both tongues are inserted and a 'click' is heard.**

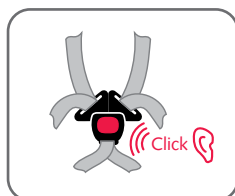
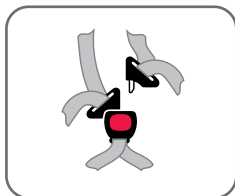
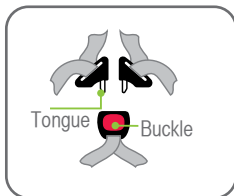

- G. Ensure slack is removed from harness lap strap by pulling shoulder straps then pull harness adjustment strap to adjust harness to a comfortable but firm fit. Ensure that any slack in harness straps is removed. Shoulder harness straps must fit firmly to the child. A loose harness could result in serious injury in an accident. Do not over tighten.

Do not use the restraint if straps do not tighten. Contact your local authorised service agent for repair.

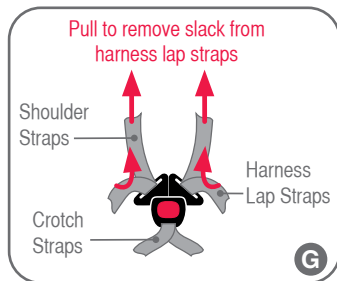

HOW TO USE

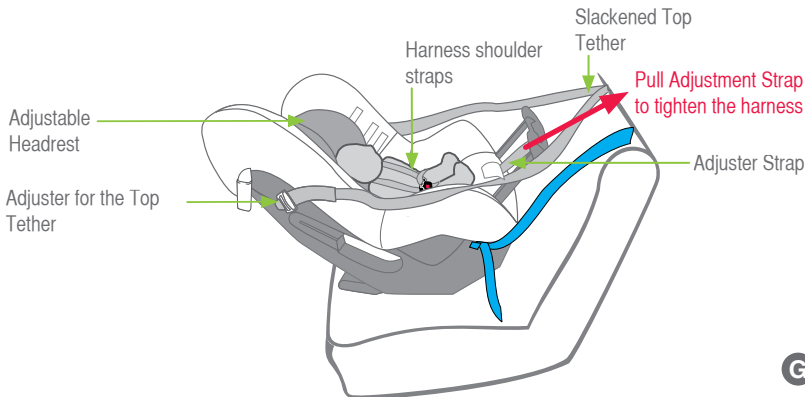

! WARNING: DO NOT LEAVE CHILDREN UNATTENDED IN THE CAR.

! CAUTION: A LOOSE HARNESS IS DANGEROUS.

Make sure that nothing is obstructing harness straps and that child's arms and legs are free with the straps in the correct location - see previous page.

Do not use the restraint if straps do not tighten and contact BRITAX Childcare Customer Service. Refer to back cover for contact details.

! IMPORTANT :

The padded insert is designed to provide extra support and comfort and may be used for smaller children. Discontinue use when Baby Padded insert is a tight fit, creates discomfort for larger children, or the child's shoulder reach the lower shoulder height marker.

HOW TO USE

- H. Adjust the top tether strap by pulling adjustment strap to remove slack as shown. Ensure the strap is not so tight as to lift the seat or deform the headrest. Only remove the slack.

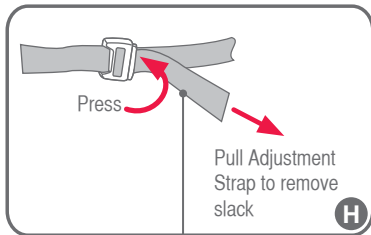

- I. Always roll up excess strap and place in the pocket provided attached to the cover.

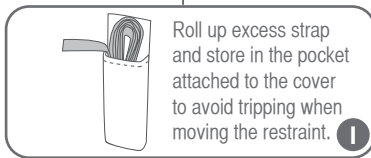

REMOVING CHILD FROM RESTRAINT

- A. Press top tether strap adjuster lever while pulling top tether straps to slacken. Allow top tether straps to fall to the sides for easy access to child.
- B. Push and hold the harness adjustment button while pulling both shoulder harness straps to fully slacken the harness.
- C. Press the red button on harness buckle, both harness tongues will be released. Insert buckle tongues into harness tongue holders to hold harness straps away from the child. Move each shoulder strap to baby's side then pick up baby.

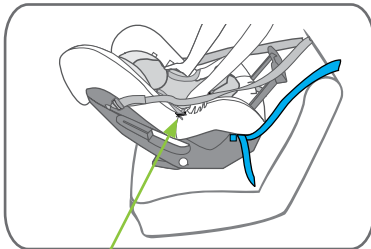

Harness Tongue Holders
(where fitted)

To remove the seat refer to page 50 for ISOFLEX installation or page 49 for seatbelt installation.

HOW TO REMOVE

REMOVE RESTRAINT FROM VEHICLE DISCONNECT TOP TETHER AND SEATBELT

- Disengage the vehicle seatbelt buckle from any lock-off devices. Remove seatbelt from the restraint belt paths.
- Remove the top tether strap from pocket and fully press top tether adjuster button (A) while pulling top tether strap (B) to slacken as shown. In some vehicles loosening of the top tether strap may be difficult. If so, try pushing the restraint against the vehicle seat back or slightly lifting the restraint to release the tension.
- Disengage the attachment clip from upper anchorage fitting. The child restraint is now disconnected.
- To store the stabilising bar, lift the front flap at the end of the seat, this uncovers the stabilising bar storage recess.
- Press the blue button on left side (facing seat) and gently push stabilising bar back and then down into the recessed area.
- Re-attach the seat pad at the end of the seat.

Store instruction manual in pocket provided and tuck pocket under trim cover.

Fully press Adjuster Button (A) while pulling Top tether Strap (B) to lengthen.

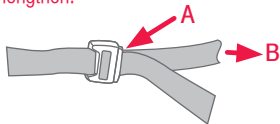

Hook and Loop attachment

Stabilising bar

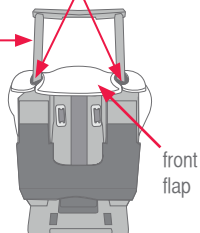

front flap

Rotate backwards

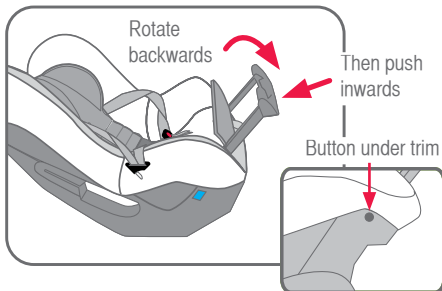

Then push inwards

Button under trim

HOW TO REMOVE

DISCONNECT TOP TETHER AND ISOFLEX CONNECTORS

To store the ISOFLEX connectors on the inside of the seat wings.

- Press the ISOFLEX strap adjuster button to release tension on the straps.
- Press each of the red release buttons on the ISOFLEX connectors and remove them from the vehicle ISOFIX low anchorages.
- Fully lengthen the ISOFLEX strap and engage each ISOFLEX connector onto its storage pin. Remove slack but do not tighten. The storage pin may be damaged if the strap is tightened.
- Remove the excess tether strap from pocket and fully press top tether adjuster button (A) while pulling top tether strap (B) to slacken as shown. In some vehicles loosening of the top tether strap may be difficult. If so, try pushing the restraint against the vehicle seat back or slightly lifting the restraint to release the tension.
- Disengage the attachment clip from upper anchorage fitting. Store loose strap in the storage pocket provided on the cover.

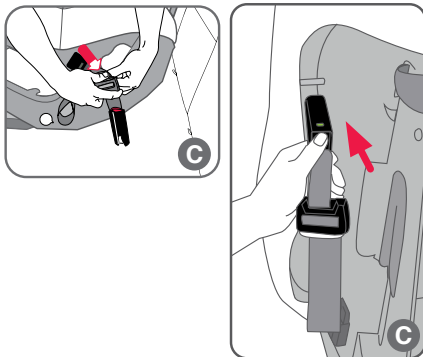
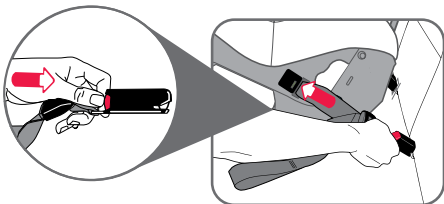

Fully press Adjuster Button (A) while pulling Top tether Strap (B) to lengthen.

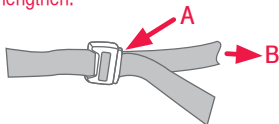

HOW TO REMOVE

D. Disengage the attachment clip from upper anchorage fitting. The child restraint is now disconnected.

Store loose strap in the storage pocket provided on the cover.

E. To store the stabilising bar, lift the front flap at the end of the seat, this uncovers the stabilising bar storage recess.

F. Press the blue button on left side (facing seat) and gently push stabilising bar back and then down into the recessed area.

G. Re-attach the seat pad at the end of the seat.

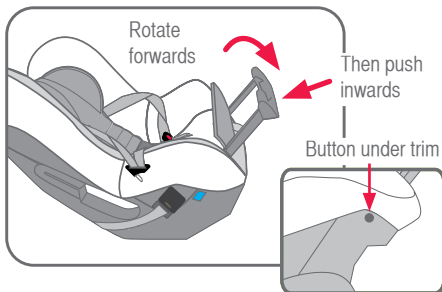
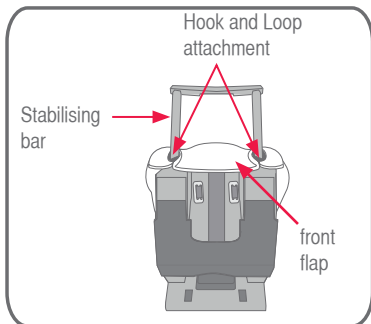

SPECIAL FEATURES: FORWARD FACING

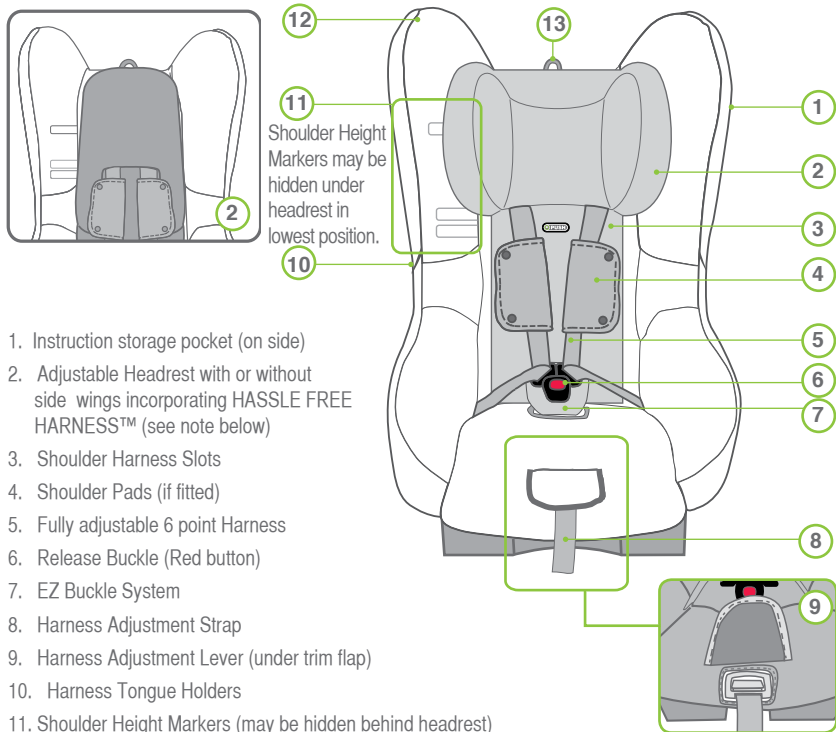

1. Instruction storage pocket (on side)
2. Adjustable Headrest with or without side wings incorporating HASSLE FREE HARNESS™ (see note below)
3. Shoulder Harness Slots
4. Shoulder Pads (if fitted)
5. Fully adjustable 6 point Harness
6. Release Buckle (Red button)
7. EZ Buckle System
8. Harness Adjustment Strap
9. Harness Adjustment Lever (under trim flap)
10. Harness Tongue Holders
11. Shoulder Height Markers (may be hidden behind headrest)
12. Padded Cover for child's comfort (may vary in style)
13. Headrest loop

Note: These instructions show the adjustable headrest with side wings, but these instructions are also applicable to restraints with an adjustable headrest without side wings.

SPECIAL FEATURES: FORWARD FACING

SEATBELT ONLY VERSION

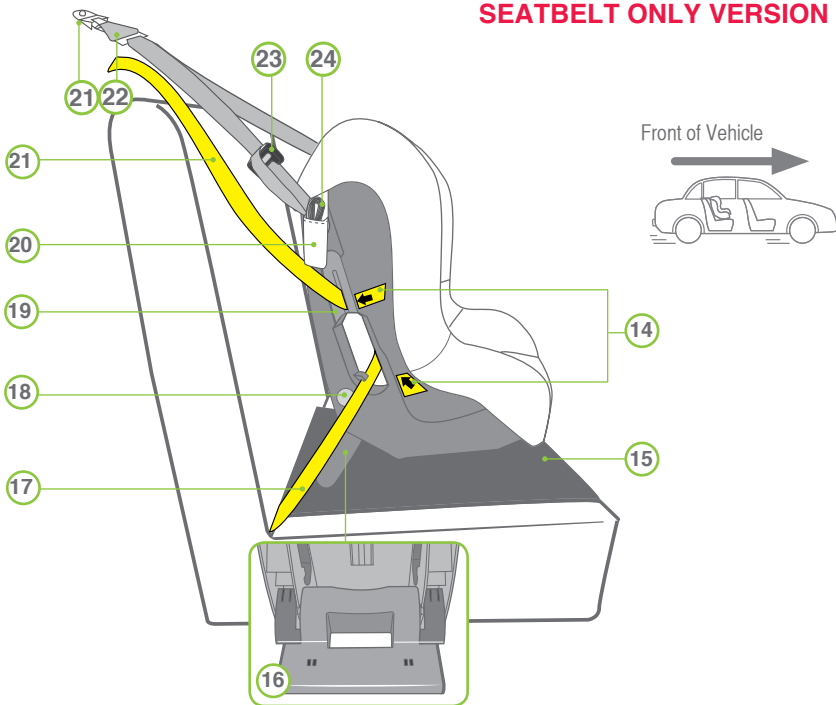

- 14. Yellow **FORWARD FACING BELT PATH** labels
- 15. Messy Mat™(if supplied)
- 16. Recline Foot (Shown in Forward Facing Mode)
- 17. Vehicle's Seatbelt
- 18. Recline Position Indicator
- 19. Upper Lock-off (if supplied)
- 20. Top Tether pocket
- 21. Car's Upper Anchorage fitting
- 22. Attachment Clip
- 23. Top Tether Strap Adjuster
- 24. Top Tether Strap (Stored)

SPECIAL FEATURES: FORWARD FACING

ISOFIX COMPATIBLE VERSION

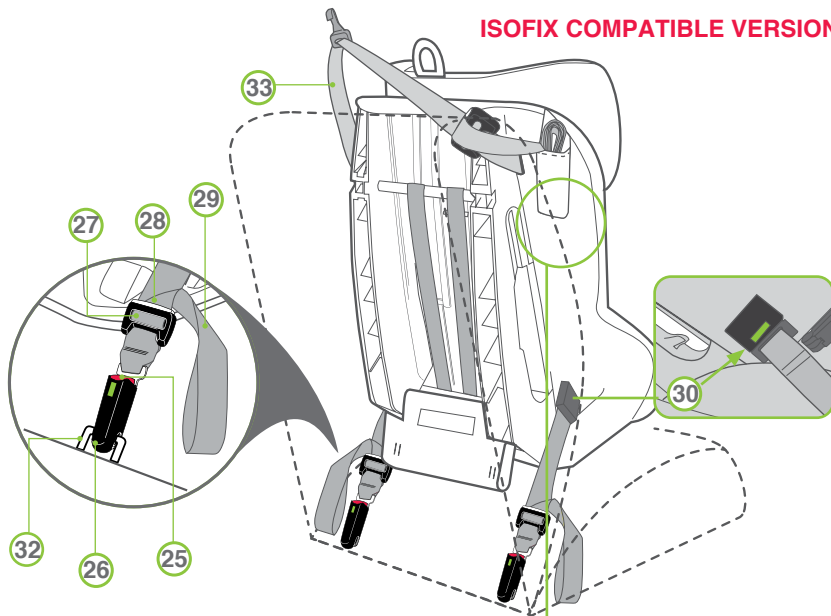

ISOFLEX CONNECTORS (IF FITTED)

- 25. ISOFLEX Connector Release Button
- 26. ISOFLEX Connector
- 27. ISOFLEX Strap Adjuster
- 28. ISOFLEX Strap Adjuster Button
- 29. ISOFLEX Strap
- 30. Tension Indicator (Green when activated)
- 31. ISOFLEX storage location
- 32. Vehicle ISOFIX low anchorage bar
- 33. Top Tether

ISOFLEX Connector is stored on the side the seat

SUITABLE FOR USE

Once the child's shoulders reach the lower or middle shoulder height marker then the seat can be changed to the forward-facing position and used until the child's shoulders reach the upper shoulder height marker.

Continue to use the restraint in forward-facing mode until the child's shoulders reaches the limit of the upper shoulder height marker. The child should not sit forward-facing until their neck muscles are able to support their head. Do not move to a Booster Seat until the child has outgrown this child restraint.

Children are at risk of serious injury if they move to a booster seat too early.

Regional Road Rules may prohibit the use of this restraint in the front seat of the vehicle until the child is 4 years of age. Check your Regional Road Rules for exemptions.

FORWARD FACING



WARNINGS

DO NOT USE RESTRAINT IN FORWARD-FACING MODE WITH THE REAR FACING MODE STABILISING BAR PULLED OUT.

Do not use the restraint without the top tether strap correctly attached.

If your vehicle is not fitted with an anchor point, please contact a Safety Restraint Fitting Station authorised by the relevant State Government Body for correct fitment of the restraint. In New Zealand contact the agent for the vehicle. The top tether strap must be attached to an upper anchorage point using an extension strap if necessary.

Do not use on any vehicle seat which faces sideways or rearwards.

If an airbag is fitted in the desired seating position where the child restraint is fitted, follow the vehicle manufacturer's warnings and instructions.

HOW TO SETUP

CONVERT THE RESTRAINT TO FORWARD FACING MODE

A. To convert the restraint to forward facing mode (from rearward facing mode), simply pull the recline foot handle and rotate the foot to the forward facing reclined position. The foot will automatically lock at the correct position.

B. Determine whether an upright or reclined position is preferred and adjust if necessary. To adjust the restraint to the fully upright position, grasp the handle on the foot, then pull the handle outwards and hold to release the lock. Rotate the foot fully downwards, then release the handle to lock the foot in the fully upright position. The label on the side of the restraint identifies the forward facing and reclined positions.

C. Check the foot is securely locked into position.



FULLY UPRIGHT
FORWARD FACING



FULLY RECLINED
FORWARD FACING

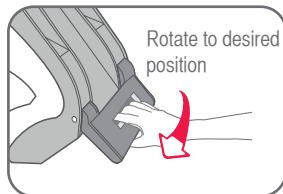
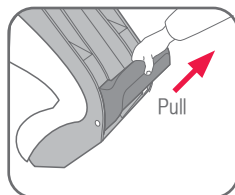
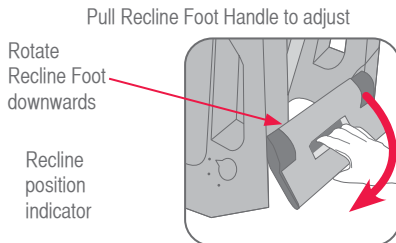

FORWARD FACING

NOTE: Do not recline excessively. Only use these positions.



HOW TO SETUP

PREPARING FOR INSTALLING INTO VEHICLE - REARWARD FACING

The restraint is normally packaged in the fully upright forward facing mode so if you need to use it rearward facing you must first fully recline the restraint, and then convert the restraint to rearward facing mode as shown below.

If upper anchorage strap is folded up for storage undo storage strap then lengthen. Fully press adjuster button (A) while pulling upper anchorage strap (B) to lengthen.

Fully press Adjuster Button (A) while pulling Upper Anchorage Strap (B) to lengthen.

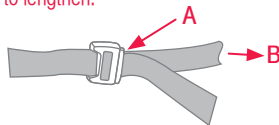

INSTALLING INTO VEHICLE FORWARD FACING (UPRIGHT OR RECLINED)

- A. Remove the seat from the vehicle by disengaging the seatbelt or ISOFLEX straps and upper anchorage strap as described on pages 50 to 52.
- B. Remove the padded insert (if fitted) as this is no longer required.
- C. To store the stabilising bar, lift the cover at the end of the seat to uncover the storage recess.

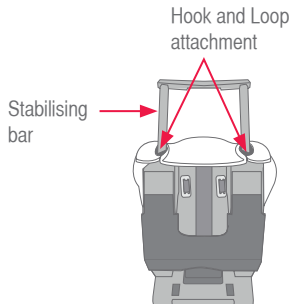

HOW TO SETUP

- D. Press the button on the side of the restraint and gently push stabilising bar back and down into the recessed area.
- E. Re-attach the cover at the end of the seat.

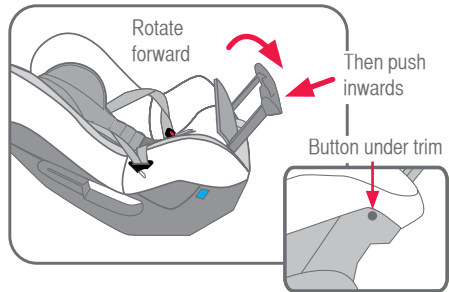

FORWARD FACING



IMPORTANT :

DO NOT USE RESTRAINT IN FORWARD-FACING POSITION WITH THE STABILISING BAR PULLED OUT.

Do not recline into rearward facing position when using restraint in forward facing mode.

HOW TO INSTALL

INSTALLING INTO VEHICLE FORWARD FACING -WITH SEATBELT

- A. Position the restraint in forward facing mode and align restraint centrally with the chosen seating position.

Some vehicle seat fabrics (particularly velours) may be damaged by a child restraint used continuously. We recommend the use of a long Messy Mat™ or thick towel to keep the vehicle seat in good condition.

- B. Fully lengthen seatbelt. Insert seatbelt tongue through the forward facing seatbelt path (yellow), ensuring that the seatbelt is behind the harness straps. Ensure the lap part of the seatbelt is below the hooks as shown in Fig D.

- C. Engage the vehicle seatbelt buckle and tongue. Remove all slack from the lap part of the seatbelt ① by pulling sash belt ②.

- D. Grasp the sash belt edge between thumb and fingers in each hand. Slide the belt up into the lock-off slot to the top of the slot. If the sash belt is not slack it may not enter the lock-off slot.

- E. Pull the sash belt through the lock-off (if fitted) to fully tighten the seatbelt. Pull the sash belt firmly through the lock-off. The child restraint should now be firmly fitted to the vehicle seat.

- F. Always check all slack is removed from the lap belt by pulling the sash belt through the lock-off

- G. Allow the excess sash belt to feed back into retractor.

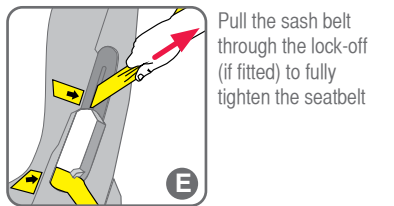
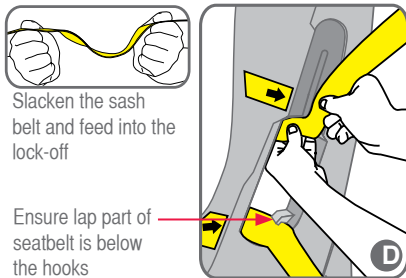
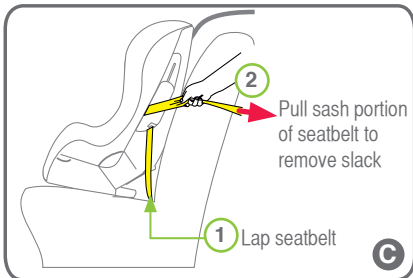

HOW TO INSTALL

H. Fit the attachment clip on the upper anchorage strap to the anchor fitting as shown. Make sure to remove as many twists as possible from the upper anchorage strap.

WARNING

Always attach the hook and remove slack

- I. Tighten adjustable top tether strap by pulling adjustment strap to remove slack as shown below, but do not over-tighten causing the restraint base to lift off the vehicle seat.
- J. Fold up excess strap and use the top tether pocket to store excess strap away from child's reach.



IMPORTANT :

Always secure the loose end of the top tether strap to prevent it hanging out of the car or being accessible by the child.

THIS RESTRAINT IS NOT SUITABLE FOR USE WHERE THE TOP TETHER STRAP MAY FALL INTO A SPLIT IN THE SEAT BACK OR OFF THE SIDE OF THE SEAT.

Always ensure that the car seatbelt is firmly restraining the restraint on the vehicle seat.

ALWAYS ATTACH TOP TETHER HOOK AND REMOVE SLACK IN THE TOP TETHER STRAP.

Check that the seatbelt is not twisted and the diagonal belt is only clamped by the lock-off which is located on the opposite side from the car seat buckle.



CAUTION:

CHILDREN CAN BE INJURED OR RESTRAINTS AND TOP TETHER STRAP DAMAGED BY UNSECURED CARGO IN A COLLISION. SECURE OR REMOVE HAZARDOUS CARGO BEFORE USING THIS CHILD RESTRAINT.

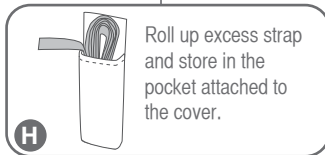
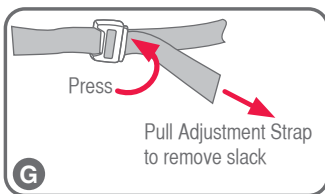
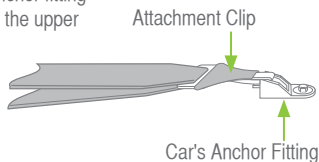

SEATBELT
FORWARD FACING

HOW TO INSTALL

Car's Upper
Anchorage Fitting

Attachment Clip

Front of Vehicle



**FORWARD FACING
BELT PATH;**
marked in yellow.

Top tether strap

Pull to remove slack,
then store the strap
in the pocket

Top Tether
Adjustment Strap

Top tether
storage
pocket

SEATBELT
FORWARD FACING

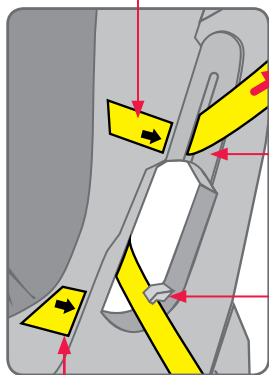

Pull to
tighten belt

Seatbelt
'Lock-off'

Hook

Forward facing
seatbelt path

**FORWARD-FACING
BELT PATH;**
marked in yellow.



IMPORTANT: Always secure the loose end of the top tether strap to prevent it hanging out of the car or being accessible by the child.

THIS RESTRAINT IS NOT SUITABLE FOR USE WHERE THE TOP TETHER STRAP MAY FALL INTO A SPLIT IN THE SEAT BACK OR OFF THE SIDE OF THE SEAT.

HOW TO INSTALL USING ISOFLEX CONNECTORS

INSTALLING THE RESTRAINT INTO THE CAR USING ISOFLEX CONNECTORS (IF FITTED) AND TOP TETHER

To prevent damage to vehicle seat it may be necessary to remove or open a trim covering the ISOFIX low anchorages.

- A. Locate the ISOFIX Low Anchorages in the vehicle rear seat. The location may be identified by one of the following symbols, or the anchorage bars may be visible.



If you cannot locate them, check your vehicle owners manual.

- B. With the restraint upright, remove both ISOFLEX connectors from storage on the upper sides of the restraint by pressing the red button on the connector.

ISOFIX low anchors of the vehicle seat

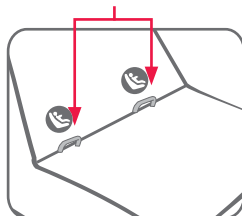

ISOFLEX
FORWARD FACING

HOW TO INSTALL USING ISOFLEX CONNECTORS

INSTALLING INTO THE CAR USING ISOFLEX (IF FITTED) AND TOP TETHER STRAP

- C. Recline instructions are shown on page 28.
- D. Press and hold the ISOFLEX strap adjuster button and pull the connector strap to fully lengthen. Repeat for both connector straps.
- E. Place the restraint in the desired location on the vehicle seat between the two ISOFIX low anchorages. Ensure the child seat is against the vehicle seat back as shown. Engage the ISOFLEX connectors into each ISOFIX low anchorage. A click may be felt a green indicator will show on the top of the ISOFLEX connector when it has engaged. Pull the adjusting strap to remove most of the slack on each side but do not tighten.
- F. Push downwards on the armrests of the child seat to compress the side of the seat into the vehicle seat. Whilst pushing, pull on adjuster strap to remove all slack and tighten the ISOFLEX strap. Repeat for the adjuster strap on the other side of the restraint. The two tension indicators will show 'green' indicating minimum tension has been applied.

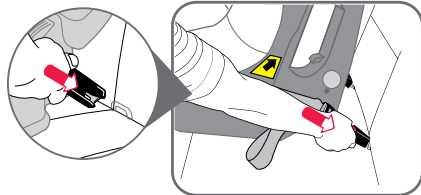

Push down here

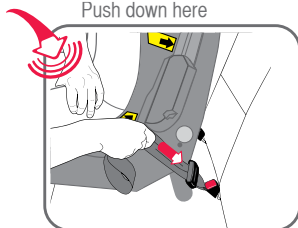

Pull ISOFLEX adjuster strap to tighten

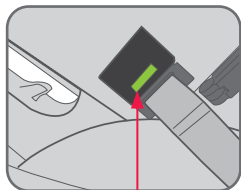

Tension indicators



IMPORTANT:

Do not attach the lower attachment connectors of two separate child restraints to the same ISOFIX low anchorages in your car.

Always attach the top tether strap to the child restraint upper anchorage in your car.

Child restraint lower attachment connectors and the ISOFIX low anchorages in your car are designed to withstand only those loads imposed by a correctly fitted child restraint.

HOW TO INSTALL USING ISOFLEX CONNECTORS

G. Fit the attachment clip on the upper anchorage strap to the anchor fitting as shown. Make sure to remove as many twists as possible from the upper anchorage strap.



WARNING

Always attach the hook and remove slack

- Tighten adjustable top tether strap by pulling adjustment strap to remove slack as shown below, but do not over-tighten causing the restraint base to lift off the vehicle seat.
- Fold up excess strap and use the top tether pocket to store excess strap behind seat away from child's reach.



IMPORTANT :

Always secure the loose end of the top tether strap to prevent it hanging out of the car or being accessible by the child.

THIS RESTRAINT IS NOT SUITABLE FOR USE WHERE THE TOP TETHER STRAP MAY FALL INTO A SPLIT IN THE SEAT BACK OR OFF THE SIDE OF THE SEAT.

Always ensure that the car seatbelt is firmly restraining the restraint on the vehicle seat.

ALWAYS ATTACH TOP TETHER HOOK AND REMOVE SLACK IN THE TOP TETHER STRAP.

Check that the seatbelt is not twisted and the diagonal belt is only clamped by the lock-off which is located on the opposite side from the car seat buckle.



CAUTION:

CHILDREN CAN BE INJURED OR RESTRAINTS AND TOP TETHER STRAP DAMAGED BY UNSECURED CARGO IN A COLLISION. SECURE OR REMOVE HAZARDOUS CARGO BEFORE USING THIS CHILD RESTRAINT.

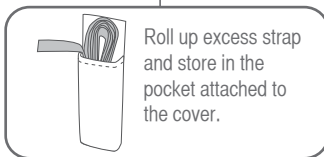
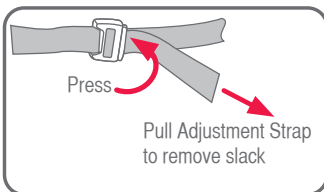
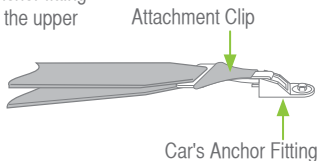

HOW TO INSTALL USING ISOFLEX

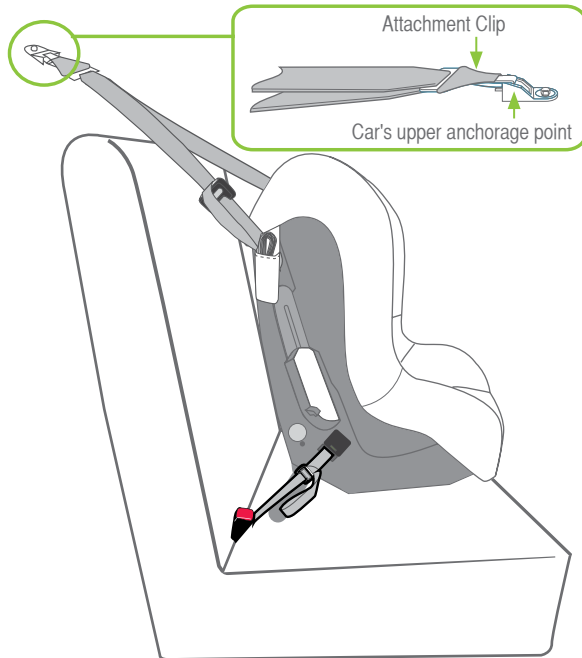

ISOFLEX
FORWARD FACING

⚠ WARNINGS

**DO NOT USE RESTRAINT IN REARWARD FACING MODE WITHOUT STABILISING BAR FULLY EXTENDED.
THE TOP TETHER STRAP MUST ALWAYS BE FITTED WHEN THE CHILD RESTRAINT IS USED IN A VEHICLE.
ALWAYS ATTACH THE HOOK AND REMOVE THE SLACK.**

HOW TO USE

HARNESS POSITION & HEADREST HEIGHT: FOR FORWARD-FACING MODE

Correct fitment of the harness is very important as it restrains the child in the restraint. The headrest must be in the correct position and the harness must fit firmly around upper torso of the child and be positioned so as to leave the child's arms and legs free.

Adjustment of the headrest automatically adjusts the harness shoulder strap position. If the headrest has side wings they should be just above the child's shoulders. If there are no side wings, the shoulder straps must be in the slots which are nearest to the child's shoulders, but not more than 25 mm below the child's shoulders.

Always adjust the height of the headrest, thus the shoulder straps as the child grows.

If the headrest is in the top position and the shoulders are above the upper shoulder height marker then the child is too tall for the restraint and the restraint should not be used; move to next type of restraint (see pages 21).

NOTE: This child restraint does not require the shoulder straps to be disconnected to adjust their height, only the headrest needs to be moved to adjust the shoulder strap position.

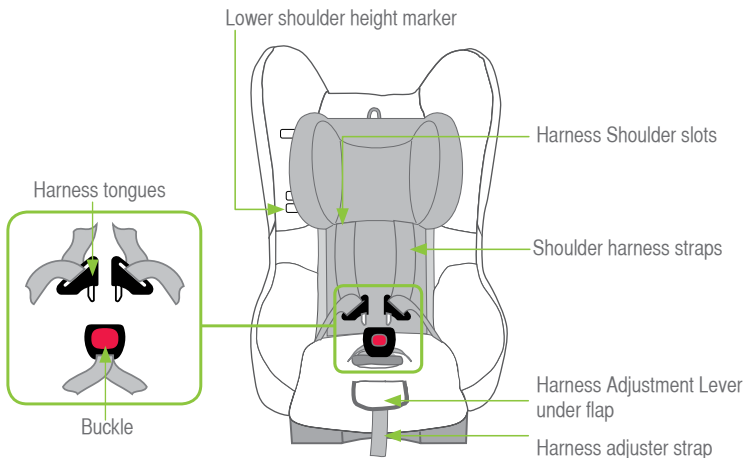

HOW TO USE

HOW TO ADJUST THE HEADREST & HASSLE FREE HARNESS™

When the child restraint is out of the vehicle, this method can be used to adjust the headrest to an approximate position for the child.

- A. Loosen the harness straps before adjusting the headrest.
- B. To make adjustments you will need to remove the child and the restraint from the vehicle or loosen the seatbelt. The next method on page 35 will be more convenient as you will not need to remove the restraint from the vehicle.
- C. To adjust the headrest, pull on the latch at the back of the restraint and move up or down to position the bottom of the headrest to be just above the child's shoulders. Release the latch to lock the headrest in position. Pull headrest upwards to check it is locked in position. Adjust the headrest and the shoulder straps to the final fit on the child.

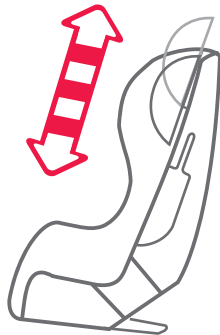
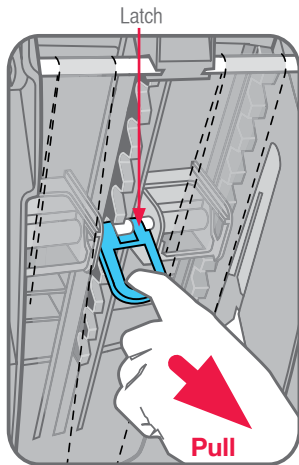

IMPORTANT :

Ensure harness and headrest are positioned so that the shoulder straps are just above or inline with the child's shoulders but not lower. The bottom of the headrest side wings will usually be just above the child's shoulders.

It is not necessary to remove the harness straps to adjust the headrest position. Refer to Care and Maintenance for cover removal page 79.

HOW TO USE

ALTERNATIVE HEADREST ADJUSTMENT METHOD.

HOW TO ADJUST THE HEADREST & HASSLE FREE HARNESS™ - Installed in vehicle

When the child restraint is installed in the vehicle forward facing, the headrest and shoulder strap slot height can be adjusted without removing the seatbelt from the restraint by using this method.

A. Loosen the harness straps before adjusting the headrest.

B. Place finger on the "PUSH" button, press in towards restraint, and lift the headrest loop to adjust upward or downward.

Be sure to use the 'push' button label as a guide. Press the 'push' button (approx. 10mm) into the recess behind the cover. Once released lift or lower the headrest using the headrest loop.

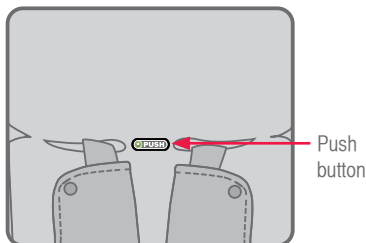

Headrest loop

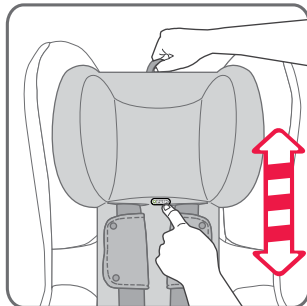
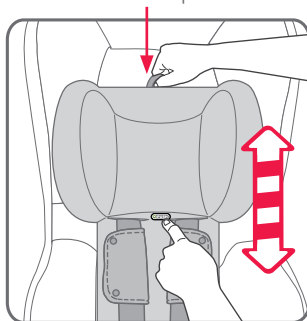

FORWARD FACING

HOW TO USE

PLACING CHILD IN THE RESTRAINT

- A. Ensure the headrest and shoulder straps are adjusted to the correct height for your child (see page 67). Loosen shoulder straps by pressing the harness adjuster and pull both shoulder straps evenly. Pull out the desired amount of slack. Place the two harness tongues into the Buckle Tongue Holder (if fitted). Move the harness buckle towards the harness adjuster for easier fitment next time you put the infant in the carrier.
- B. Place child in the restraint and feed each arm through the shoulder straps. Pull harness buckle up between child's legs.

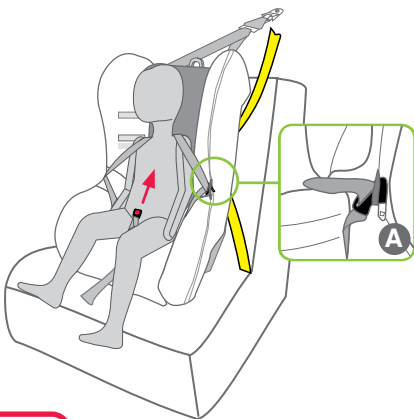

FORWARD FACING



IMPORTANT :

Always adjust the height of the headrest, thus the shoulder straps as the child grows.

- C. Fit either harness tongue into the harness buckle followed by the other tongue. A click is heard when the last tongue is fully engaged. Should the second tongue not engage - press the red button and reinsert the tongues. Ensure secure engagement by pulling harness straps. If the harness buckle does not engage correctly then it may require cleaning or seek replacement - refer to page 75. **The buckle tongues are fully engaged when both tongues are inserted and 'click' is heard.**

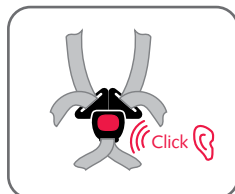
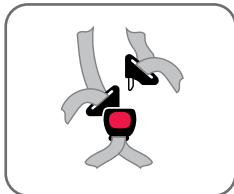
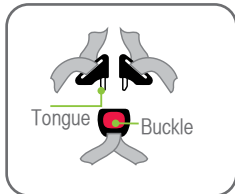

HOW TO USE

- D. Ensure slack is removed from harness lap strap by pulling shoulder straps then pull harness adjustment strap to adjust harness to a comfortable but firm fit. Ensure that any slack in harness straps is removed. Shoulder harness straps must fit firmly to the child. A loose harness could result in serious injury in an accident.

Do not use the restraint if straps do not tighten. Contact your local authorised service agent for repair.

Store instruction manual in pocket provided and tuck pocket under trim cover.

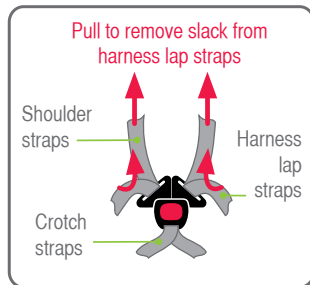

FORWARD FACING



WARNING: DO NOT LEAVE CHILDREN UNATTENDED IN THE CAR.



CAUTION: A LOOSE HARNESS IS DANGEROUS.

Make sure that nothing is obstructing harness straps and that child's arms and legs are free with the straps in the correct location - see previous page.

Do not use the restraint if straps do not tighten and contact BRITAX Childcare Customer Service. Refer to back cover for contact details.

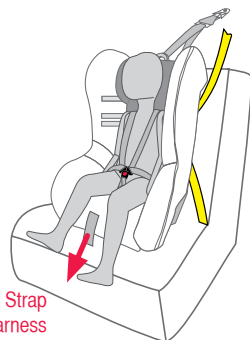

HOW TO REMOVE

REMOVING CHILD FROM RESTRAINT

- A. Push and hold the harness adjustment lever while pulling both shoulder harness straps to slacken harness to the desired amount.
- B. Press the red button on harness buckle, both harness tongues will be released. Insert buckle tongues into harness tongue holders to hold harness straps away from the child. Move each shoulder strap aside.

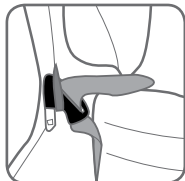

Harness tongue holders (where fitted)

To remove the seat refer to page 73 for ISOFLEX or below for seatbelt installation.

REMOVE RESTRAINT FROM VEHICLE FITTED WITH SEATBELT

- A. Remove the top tether strap from pocket and fully press top tether adjuster button (A) while pulling top tether strap (B) to slacken as shown. In some vehicles loosening of the top tether strap may be difficult. If so, try pushing the restraint against the vehicle seat back or slightly lifting the restraint to release the tension.
- B. Disengage the attachment clip from upper anchorage fitting.
- C. Store loose strap in the top tether storage pocket provided on the cover.
- D. Disengage the vehicle seatbelt buckle from any lock-off devices on both sides of the restraint.
- E. Disengage seatbelt from the restraint belt paths. Allow seatbelt to feed back into seatbelt retractor.

Fully press Adjuster Button (A) while pulling top tether strap (B) to lengthen.

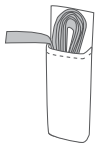
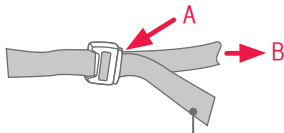

Roll up excess strap and store in the pocket attached to the cover to avoid tripping when moving the restraint.

HOW TO REMOVE

REMOVE RESTRAINT FROM VEHICLE FITTED WITH ISOFLEX

To store the ISOFLEX connectors on the inside of the seat wings.

- A. Press the ISOFLEX strap adjuster button to release tension on the straps.
- B. Press each of the red release buttons on the ISOFLEX connectors and remove them from the vehicle ISOFIX low anchorages.
- C. Fully lengthen the ISOFLEX strap and engage each ISOFLEX connector onto its storage pin.

Remove slack but do not tighten. The storage pin may be damaged if the strap is tightened.

- D. Remove the excess tether strap from pocket and fully press top tether adjuster button (A) while pulling top tether strap (B) to slacken as shown. In some vehicles loosening of the top tether strap may be difficult. If so, try pushing the restraint against the vehicle seat back or slightly lifting the restraint to release the tension.
- E. Disengage the attachment clip from upper anchorage fitting.

Store loose strap in the storage pocket provided on the cover.

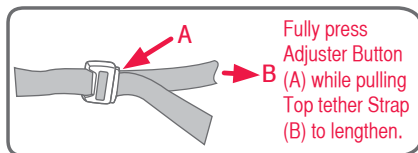
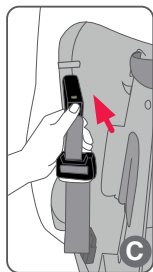
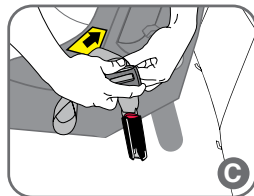
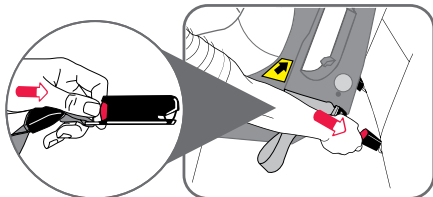

FORWARD FACING

HOW TO INSTALL IN AN AIRCRAFT

THIS RESTRAINT IS SUITABLE FOR USE ON AN AIRCRAFT WHEN INSTALLED AS DIRECTED.

HOW TO INSTALL USING AIRCRAFT LAP BELT

The child restraint must be used in accordance with the aircraft procedures, and any directions from the aircraft operator, pilot or crew.

Some child restraints may not fit in smaller aircraft and can not be used with aircraft seatbelts that contain airbags unless they can be disabled.

Inform the aircraft operator that a child restraint is intended to be used on the aircraft when booking the flight as the child restraint may not be suitable for use in that operator's aircraft.

Follow the instructions of the flight crew or pilot.

For use of the child restraint in cars in countries other than Australia and New Zealand as follows:

- (A) The child restraint may not be acceptable for use in cars.
- (B) The user may need to consult the country's local authorities, car hire companies, car insurance companies, etc. for advice.

TO FIT THE CHILD RESTRAINT TO THE AIRCRAFT SEAT IN FORWARD FACING:

- A. Set the recline position to fully upright. Position the restraint in forward-facing mode and align centrally with the chosen seating position. We recommend that you fit the restraint nearest the window or in a middle seat if in centre seating area, so it will not interfere with an adult exiting the row of seats. If possible, lift the armrests out of the way to improve access to installing the aircraft lap belt. However airline staff will direct you to the desired seat position.
- B. The top tether is not required to be used to fit the child restraint in an aircraft. Shorten the top tether strap and store in its storage pocket. Attach the tether clip to the elastic loop provided on the restraint as shown.

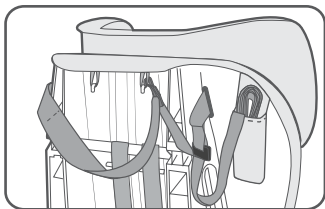

IMPORTANT:

When the tether hook is stored on the loop always remember to attach the upper tether strap when reinstalling in the car.

HOW TO INSTALL IN AN AIRCRAFT

- C. Fully lengthen seatbelt. Thread the seatbelt into **BELT PATH - FORWARD FACING** seatbelt path marker (lower yellow marker) as shown, ensuring that the seatbelt is behind the harness straps and below the hook as shown, on each side. Engage seatbelt buckle and tongue.
- D. Push down on the restraint and remove all slack from the seatbelt.
- E. Place child in the seat, fit the harness, engage buckle and remove the slack in the harness.

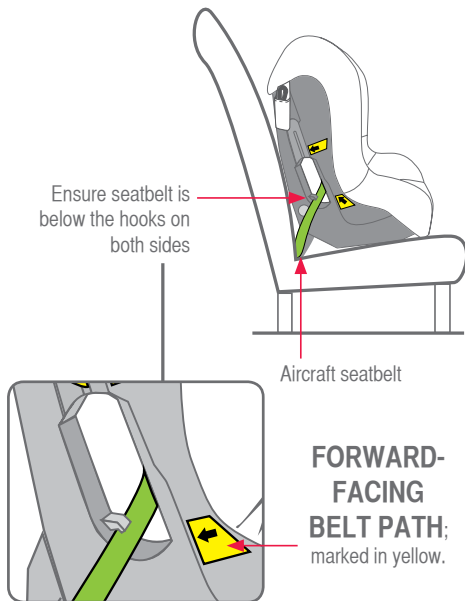



HOW TO INSTALL IN AN AIRCRAFT

Aircraft label is located on the back of the restraint and demonstrates suitability for use on an aircraft.



This Child Restraint System meets the standards for use in aircraft as recommended by the Civil Aviation Safety Authority of Australia and the Civil Aviation Authority of New Zealand.

Only to be used on aircraft with the permission of the aircraft operator, pilot and crew.

SUITABLE FOR FORWARD USE

The top tether strap is not required to be used onboard aircraft and should be stowed securely.

CARE & MAINTENANCE

REGULAR CARE OF THIS RESTRAINT:

Please check the following items regularly to ensure the safety of your child:

- A. Check the webbing of the straps for fraying,
- B. Check there are no cracks in moulding,
- C. Check the harness adjuster is operating and is clamping the webbing,
- D. Ensure the buckle is free of fluff, liquid or other matter that may enter the buckle slots. Clean the buckle if it is sluggish to engage. See next page.
- E. If any part of the restraint is cracked or broken, seek repair immediately - contact Britax Customer Service 1300 303 330

CLEANING CAR SEAT

Use only mild soap and water to clean all metal and plastic parts of the restraint. Do not use chemicals or cleaning agents.

HARDWARE: Use only mild soap and water to clean all webbing, metal and plastic parts of your child's restraint, using a damp cloth.

Do not use chemicals or cleaning agents. Do not try and place any hardware into a washing machine.

STRAPS/HARNESS: We only recommend that you spot clean the straps/harness with a damp sponge. The harness straps can be soaked, however they must be thoroughly dried without excessive heat (never tumble dry). The harness straps should not be placed in a washing machine as this may cause damage to the stitching or even damage your washing machine.

COVER: The restraint has a flame retardant cover which is removable for cleaning, please clip the hook and loop together on the cover and seat pad (if supplied) to prevent any damage to the cover when washing. Cleaning instructions are on the care label attached to the cover. For machine washable covers use gentle cycle, cold water only, rinse well and dry on a flat surface. Do not tumble dry, bleach or dry-clean. May be hand washed. Follow the care label on the cover.

CARE & MAINTENANCE

BUCKLE OPERATION

To ensure the buckle remains operational the inside of the buckle must be kept free of liquids, sand, dirt, fluff, food or similar substances. If the buckle is not operating or you do not hear a strong audible click when the second tongue is inserted then the buckle needs to be washed or replaced. The buckle is fully engaged when both tongues are inserted and a 'click' is heard. Contact Customer Service for assistance.

TO CLEAN HARNESS BUCKLE:

If sticky liquids such as baby formula, fruit juice, etc. get inside your harness buckle, it may become sluggish. An indication of a sluggish harness buckle is that you cannot hear a click when engaging the last harness tongues. To restore the harness buckle to good working order it needs to be cleaned as follows:

- A. Remove the harness buckle from the restraint: From the underside of the restraint pull each crotch strap 3-bar slide, turn the 3-bar slide on its side and push back through the slot.
- B. Place the harness buckle under warm (max. 40 degrees Celsius) running water as shown below. Let the water run through the mouth of the buckle for five minutes. Check the harness buckle is clean by engaging the harness tongues and buckle several times until you hear a click.
- C. If you still cannot hear a strong audible click then repeat the cleaning process several times.
- D. Refit the harness buckle to the restraint ensuring the red button facing outwards and the 3-bar slide is fed through the same slots.

If the Harness Buckle cannot be returned to its original working condition then contact BRITAX Customer Service for assistance.

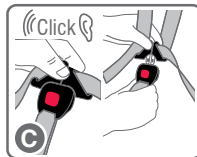
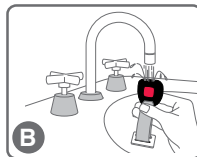
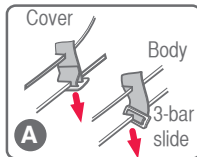

CARE & MAINTENANCE

COVER (STYLE MAY VARY)

The restraint has a flame retardant cover which is removable for cleaning. Cleaning instructions are on the care label attached to the cover. If a fluffy cover is fitted then washing cover prior to use should remove excess fluff.

Drying the padded insert will take additional time as the comfort foam will absorb moisture. Before washing re-engage any hook and loop on the cover and padded insert to prevent fabric damage. The cover has been designed to protect your child when seated in the restraint. Care should be taken if children either eat or drink while in the restraint as some food or drink products may cause damage or marking to the cover. Wash or clean immediately.

Do not pull sticky items from covers as the cover may be damaged - soak in water and gently remove.

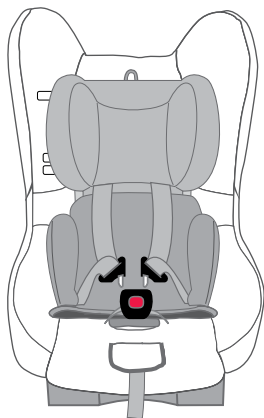

IMPORTANT:

Do not pull sticky items from covers as the cover may be damaged - soak in water and gently remove.

TO REMOVE COVER:

NOTE: There is no need to disconnect the shoulder harness assembly straps from restraint.

- A. Remove the restraint from vehicle.
- B. Disengage the harness tongues from the harness buckle.
- C. Remove any accessories, padded insert, crotch pad and shoulder pads (if fitted).

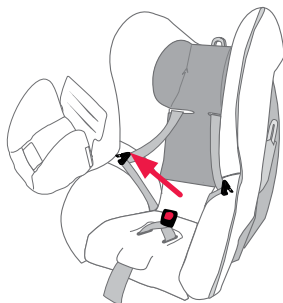

CARE & MAINTENANCE

To remove headrest cover from adjustable headrest without side wings:

Remove headrest cover by unclipping the press studs next to shoulder harness, place shoulder harness straps to the side. Unhook the elastic loop attached to the headrest cover. Lift over and away from headrest without side wings.

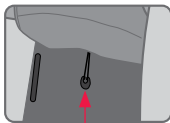
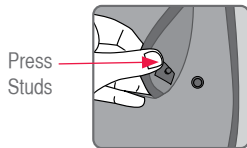

Unhook elastic loop attached to headrest cover

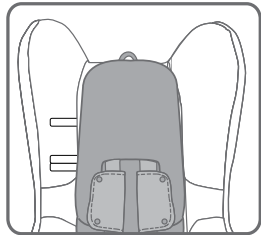

To Remove Alternative headrest cover with soft wings:

Remove headrest cover by unclipping the press studs next to shoulder harness. Unclip press studs from headrest without side wings moulding on each side. Place shoulder harness straps to the side. Lift headrest cover over and away from headrest without side wings.

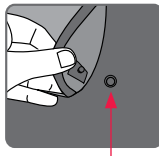
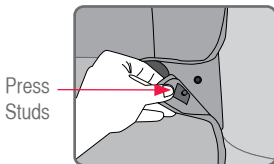

Unclip press stud from moulding

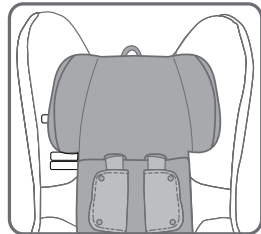

CARE & MAINTENANCE

To remove headrest cover from adjustable headrest with side wings:

Remove headrest cover by unclipping the press studs next to the shoulder harness. At the back of the headrest hardware lift elastic loops over headrest and peel cover away from the seat.

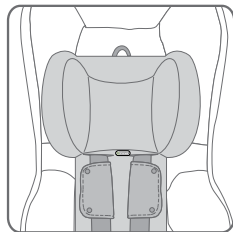
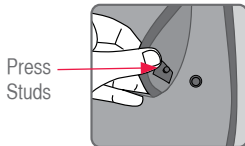

- D. Unhook the elastic loops at the top of the cover located at the back of the restraint and the elastic loops at the bottom of the restraint located under the front of the restraint.

Unhook elastic loop at the back of the restraint

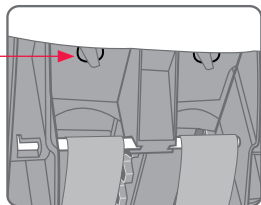

CARE & MAINTENANCE

- E. Remove the cover by unclipping any press studs or hook and loops.

Unclip the press studs

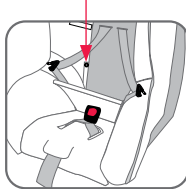

Peel away the hook and loop

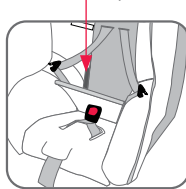

- F. Feed crotch buckle, crotch strap slot in the cover and feed the shoulder harness behind the centre flap.

Crotch slot

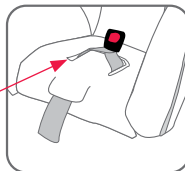

IMPORTANT:

Do not remove the impact foam attached to the side wings.
Ensure the shoulder harness is routed over the bar if harness straps are removed.

TO REPLACE COVER:

- A. Feed the harness tongues and shoulder straps through the side slots in the cover.
- B. Stretch the cover over the top of the restraint first, then the sides, then stretch the cover around the rim of the restraint. Attach the elastic loops at the top of the cover located at the back of the restraint and the elastic loops at the bottom of the restraint located under the front of the restraint. Re-attach and press studs or hook and loops together. Feed the crotch buckle through slot in cover.

Hook elastic loop at the back of the restraint

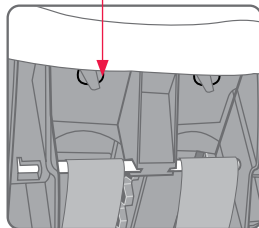

CARE & MAINTENANCE

C. Pull the adjuster strap through the cover. Ensure none of the harness straps are twisted.

To replace headrest cover for adjustable headrest without side wings:

Fit headrest cover over headrest without side wings, feed through shoulder harness straps and re-attach the press studs. Hook elastic loop to the headrest without side wings hardware.

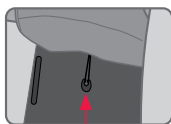
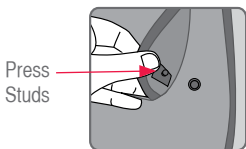
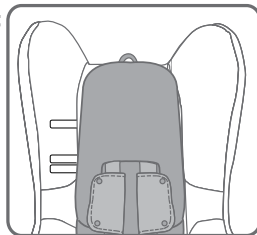

Hook elastic loop headrest without side wings hardware

Alternative headrest cover with soft wings:

Lift headrest cover over headrest without side wings whilst feeding through the lever. Re-attach the press studs on the headrest without side wings moulding. Feed through shoulder harness straps. Clip together press studs next to shoulder harness.

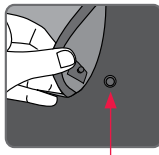
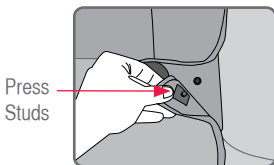
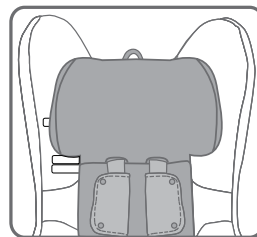

Press stud from moulding

CARE & MAINTENANCE

To replace headrest cover for adjustable headrest with side wings:

Lift headrest cover over headrest, place elastic loops behind headrest and clip press studs together next to shoulder harness.

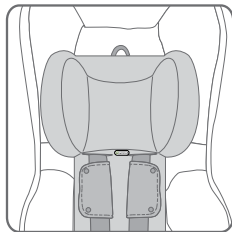
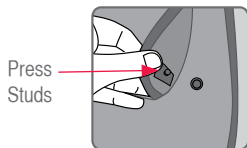

Refit the padded insert (if fitted) or other accessories if required. If the headrest has moved reset the headrest so the shoulder straps are positioned correctly for the child. See page 43 for Rearward Facing and page 67 for Forward facing.

CARE & MAINTENANCE

TO REPLACE SHOULDER STRAPS:

If the harness straps have been removed from the metal strap connector.

- A. Refit the harness strap by feeding through the previous shoulder strap slots in the headrest. **You MUST thread the shoulder strap OVER cross bar** and then re-attach the straps to metal strap connector at the back of the seat (as shown here). Check that the straps are connected and none of the harness straps are twisted.
- B. Refit any cover trims and/or accessories as per their instructions.

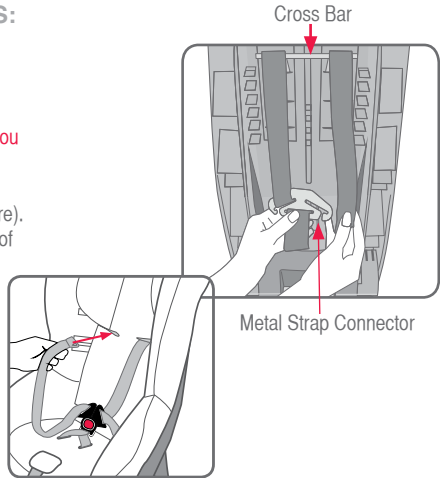

ONLY USE BRITAX SAFE-N-SOUND SEAT COVERS AND ACCESSORIES THAT ARE DESIGNED AND TESTED FOR USE WITH THIS PRODUCT.



VERY IMPORTANT:

Only replace the cover with Safe-n-Sound supplied replacement cover with identical shoulder height markers or a replacement cover meeting AS/NZS 8005.

ACCESSORIES

Use of aftermarket accessories, that is, accessories not provided with this child restraint can reduce the safety of the child restraint and may cause injury or death. Always follow the instructions covering the use of accessories in these instructions or the instructions provided with the accessory. If an aftermarket accessory is used that is not recommended by Britax then ensure that the accessory is for this restraint and compliant with AS/NZS 8005 and is stated as suitable for use with this child restraint.

The following instructions apply to accessories that may be supplied with this restraint at point of purchase. If not, a variety of Britax Safe-n-Sound accessories are available from various retailers of Britax Safe-n-Sound products.

SHOULDER PADS (IF FITTED)

Shoulder pads are designed to provide extra comfort for baby or child and are easily fitted to the shoulder harness straps by:

- A. Pull apart fasteners and remove shoulder pads from harness.
- B. Re-fit shoulder pads to harness and attach fasteners for use.

POCKETS (IF FITTED)

The pockets sewn on the trim are designed for your convenience. They can hold those necessary items that you need at a moments notice. e.g. Bottle, face washer, toy etc. They can also hold a CD or MP3 player.

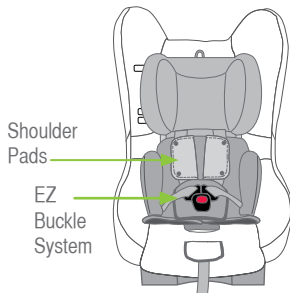

CAUTION:

If using the pocket to store filled bottles, please ensure contents are not contaminated due to prolonged storage. Ensure contents are not crushed by car door when closing.

EZ BUCKLE SYSTEM (WHERE FITTED)

EZ Buckle system retains the harness buckle and flips it into a forward position when the tongue are disengaged and prevents the child from sitting on the buckle when boarding.

- Feed EZ Buckle system through slot in front of crotch buckle slot
- Feed Crotch buckle through slot in EZ Buckle system so it just passes through the slot as shown. Ensure that the EZ Buckle system is behind the buckle. See illustration C.

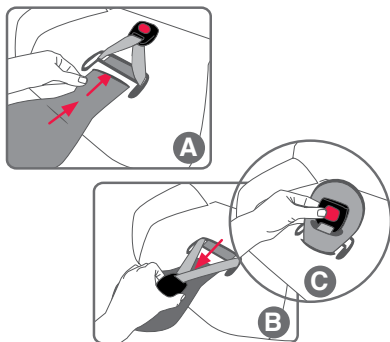

PADDED INSERT - STYLE MAY VARY

Your restraint will be supplied with either a full or half padded insert which is designed to snugly support your baby. If supplied, the full padded insert is suitable for small to medium baby. The insert can be used with the headrest in the lower three positions. When adjusting to the fourth lowest position it is then time to discontinue the use of the full padded insert. Discontinue use if the padded insert is a tight fit or creates discomfort.

If supplied, the half padded insert may be used until the child's shoulders reach the lower shoulder height marker, or the padded insert causes discomfort.

The padded inserts are not suitable for forward facing use. Fit as follows:-

- Disconnect buckle and place insert under shoulder and lap straps.
- Feed the crotch strap through the flap in the padded insert and re-connect buckle.

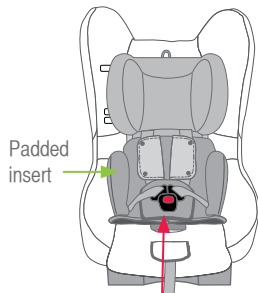

Pull crotch strap through flap in padded insert.

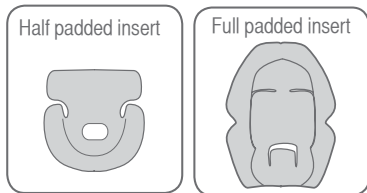

ACCESSORIES

MESSY MAT™ (IF SUPPLIED)

The Messy Mats have been specifically designed to protect your vehicle seat from damage by the child restraint and children's shoes rubbing against it. If the Messy Mat has been supplied it must be used to protect the car upholstery.

Place pocket on edge of seat, smooth back toward seat join ('A') and fit in any excess Messy Mat into the join of the car seat ('A').



CAUTION:

The Messy Mat pocket is only for small, light items. **DO NOT** overload the pocket with heavy, bulky items as this may damage the pocket or cause passengers to trip over them.

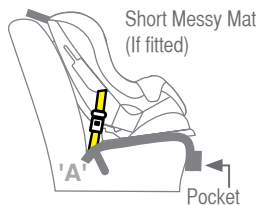
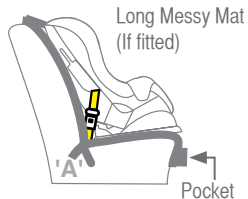

Note: Some Messy Mats may not have pockets.

INSTALLATION OF CAR'S UPPER ANCHOR FITTING

Consult the vehicle owner's handbook for location of anchorage fittings or anchorage points and the possible use of spacers. Some vehicles may have an anchor fitting fitted by the vehicle manufacturer. If anchorage points cannot be found refer to car manufacturer or local child restraint fitting station or traffic authority for optimum position of upper anchorage point and the use of spacers.

TOP TETHER STRAP



IMPORTANT:

THE ATTACHMENT CLIP COVER MUST ALWAYS BE USED AS IT PREVENTS THE RISK OF INCORRECT FITMENT OF THE ATTACHMENT CLIP TO THE UPPER ANCHORAGE POINT. BEFORE EACH USE OF THE RESTRAINT ALWAYS ENSURE THAT THE ATTACHMENT CLIP IS CORRECTLY ENGAGED TO THE UPPER ANCHORAGE POINT AND NOT HOOKED TO OR FITTED TO, ANY OTHER OBJECT. THIS IS ESPECIALLY IMPORTANT IN VEHICLES SUCH AS STATION WAGONS, VANS, HATCH BACKS OR VEHICLES WITHOUT A FIXED PARCEL SHELF, SINCE THE ANCHOR POINT IS USUALLY NOT VISIBLE.

IMPORTANT INSTALLATION NOTE:

In some vehicles the upper anchorage point in the rear vertical panel can only be installed in one way. Please refer to vehicle owner's handbook or a child restraint fitting station for correct method.

INSTALLATION OF CAR'S UPPER ANCHOR FITTING

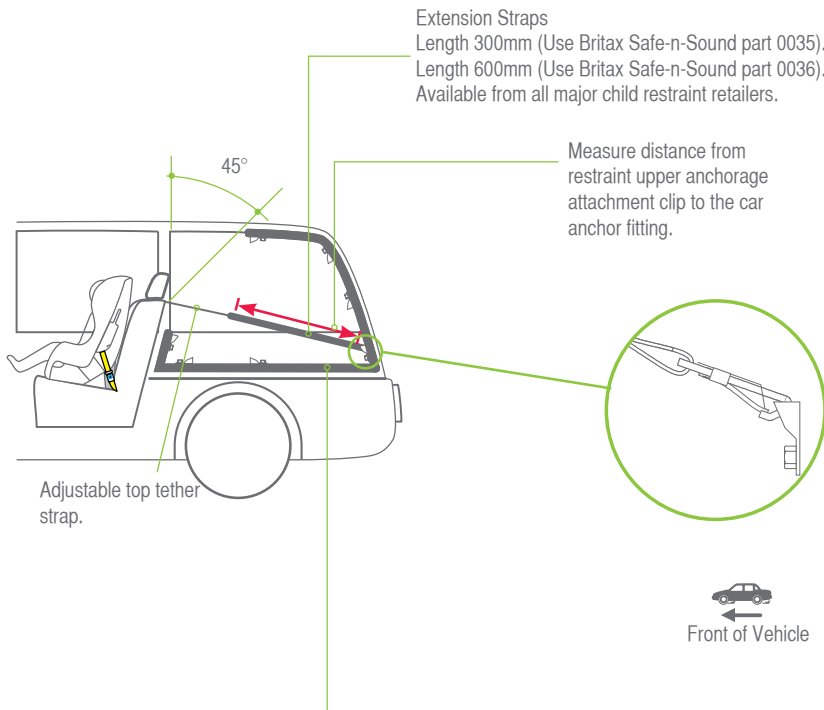

The shaded areas of this diagram illustrate the possible locations of the upper anchorage point (car anchor fitting). Within each shaded area is an upper anchorage point showing the correct way to install the fitting. Ensure the upper anchorage point is aligned as illustrated unless stated otherwise in the vehicle owner's handbook.

INSTALLATION OF CAR'S UPPER ANCHOR FITTING

IF THE CAR IS FITTED WITH CHILD RESTRAINT UPPER ANCHORAGE POINT

Locate the upper anchorage point behind the rear seating position. (Consult the car owners handbook for the location of the upper anchorage point). The upper anchorage point should be directly behind and central to the restraint. Remove thread plug from the parcel shelf/floor/roof, etc. and install attachment bolt and fitting as shown in Fig 1.

CAUTION: DO NOT OVERTIGHTEN ATTACHMENT BOLT. OVERTIGHTENING MAY FRACTURE OR BREAK BOLT. MAXIMUM TORQUE IS 20 Nm(14.75 ft.lb.)

Note: Minimum of five full turns of attachment bolt is required before tightening force is applied.

IF THE CAR IS NOT FITTED WITH CHILD RESTRAINT UPPER ANCHORAGE POINTS

For Sedans only - Drill 9mm diameter hole in the parcel shelf on the centre line of the seating position as shown in Fig 3. Before drilling the hole, check the underside for accessibility. Install the attachment bolt as shown in Fig 2. It is recommended that this installation be carried out by a child restraint fitting station or licenced motor mechanic.

For vehicles other than Sedans - In Australia, consult your nearest child restraint fitting station or traffic authority for vehicle inspection to find the best, correct position for the placement of the upper anchorage point, and for the correct attachment bolt length and use of spacers. In New Zealand, consult the agent for the vehicle. Note to Queensland purchasers: The installation of anchorage points must be approved by authorised officers appointed by Queensland Transport. Authorised officers can be sourced from all Queensland Transport Customer Service and Queensland Ambulance Service Centres.

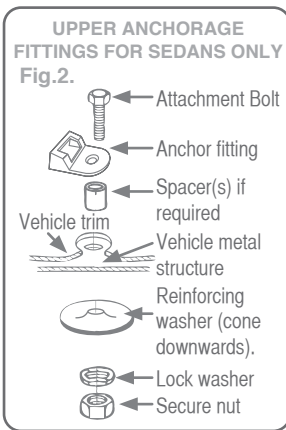
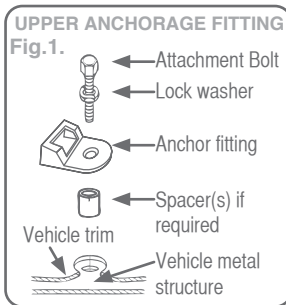

INSTALLATION OF CAR'S UPPER ANCHOR FITTING

ONLY USE A 5/16 UNC GRADE 5 BOLT. IF THE BOLT IS NOT THE CORRECT LENGTH THE CAR MANUFACTURER'S HAND BOOK CAN PROVIDE ADVICE ON THE CORRECT LENGTH BOLT.



WARNING

CHILD RESTRAINTS MUST NOT BE ATTACHED TO UNSOUND METAL OR TO WOOD, OR SYNTHETIC STRUCTURES. WHEN DRILLING 9 MM HOLE DO NOT DRILL THROUGH FUEL LINES, FUEL TANKS, ELECTRICAL WIRING, OR RADIO SPEAKERS. WEBBING STRAPS MUST BE PROTECTED FROM SHARP CORNERS AND EDGES. THE ANCHOR FITTING MUST BE USED ONLY AS DESCRIBED ABOVE. IT MUST NOT BE HOOKED ONTO ANY OTHER OBJECT.

CAR INSTALLATION ACCESSORIES (From retailers of Britax Safe-n-Sound products)

EXTRA ANCHOR KITS: Available for using the restraint in additional cars.
Re-order no: 0038

EXTENSION STRAPS: May be required for cars without a fixed parcel shelf.
Re-order no: 0035 (length 300mm) or
0036 (length 600mm)



NOTE: Marking on the top of a Grade 5 Bolt. Do not use any bolt without these marks.



Front of Vehicle

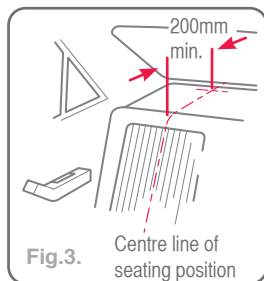

Fig.3.

Centre line of seating position

SAFETY

Never hold a baby in arms when riding in a motor vehicle. In this position the baby could be thrown against the dashboard, windscreen or other occupant and suffer serious injury or death.

When riding in a motor vehicle never nurse a baby and use the same seat belt for both of you. In this position the baby or child could be crushed.

Never breast feed a baby while car is in motion.

Children must be secured in appropriate restraints at all times when the car is in motion. Children travelling unrestrained and standing up in the car are in danger of serious injury or death. Traffic regulations in all states require children to be secured in child restraints or adult seat belts where available.

Plan your trip with frequent comfort stops to reduce stress on babies, young children and driver. Keep the car well ventilated to reduce heat stress. Car windows should be kept open to maintain a good flow of fresh air.

Never leave babies or toddlers in a stationary car because of the risk of heat exhaustion.

Ensure babies and toddlers are adequately shaded from direct sunlight through side or rear windows.

Check the car is ventilated by use opening windows or using the car's ventilation system taking in external air. Recirculation setting is not suitable for providing ventilation.

Be on guard against carbon monoxide poisoning which can occur through only a slight leak in the exhaust system while travelling in a closed car.

Securely stow all heavy objects, feeding bottles, etc. that could become missiles during an accident and cause injury to any occupant.

CLOTHING/BATHING

Since it is often warmer in the car, dress the baby in light clothing.

Do not harness an infant wrapped in a blanket or swaddled. Any blanket or wrap must only be placed over the harness and infant.

IN CASE OF ACCIDENT

If your restraint has been involved in a severe crash, you should destroy the restraint even if no damage is obvious. Some insurance companies offer vehicle insurance which covers or partially covers the replacement of your child restraint. Contact your insurance company for further details. Your insurance company may require you to keep the child restraint for assessment, **but do not use the child restraint after a severe crash**. To assist you in making an accident insurance claim cut the following statement and include it with your claim.

NOTICE TO INSURANCE COMPANY CHILD RESTRAINT INVOLVED IN AN ACCIDENT

All Britax Safe-n-Sound child restraints are manufactured to Australian/New Zealand Standards AS/NZS1754-2013 which require us to advise users of child restraints to "Destroy the entire restraint if it has been in use in a severe crash, even if no damage is obvious". The joint Australian/New Zealand Standards committee CS/85, advise that this statement applies whether a child was in the child restraint or not. A severe crash, we consider as being one where the main body structure of the vehicle is distorted.

There is no method of determining if the restraint has been damaged and we concur with the Australian/New Zealand Standards in recommending destruction of the child restraint.

This notice is to advise you of the requirements of the Australian/New Zealand Standards and our obligation in complying with the standards. Please assist the owner of this restraint in their claim.

Britax Childcare Pty. Ltd.

(Incorporated in Victoria)

A.B.N 55 006 773 600

Head office and registered address:
99 Derby Road Sunshine Victoria 3020
PO Box 147 Sunshine Victoria 3020
Telephone: 1300 303 330

New Zealand Office:
Britax Childcare NZ Limited.
PO Box 100-247 Auckland 9
Telephone: 0508 688 822



IN CASE OF ACCIDENT

CRASH EXCHANGE

We would never want you to experience an accident, but unfortunately accidents do happen.

If you experience an accident you may be eligible for a free replacement.

The Britax Safe-n-Sound Crash Exchange Program is a voluntary program designed to ensure that our children are safe and that any seat that may have experienced a severe crash is taken out of the market.

There is no method of determining if the restraint has been damaged in a severe crash, so the restraint should be destroyed as the crash may reduce the child restraints ability to perform.

Since its inception in 2006, the Crash Exchange program has helped 100's of families ensure that their children have new restraints and that the restraints are not sold second hand placing others at risk.

Our Crash Exchange Terms and Application form are accessible on our website. Please visit www.britax.com.au for further information.

AUSTRALIA

Britax Childcare Pty. Ltd.
A.B.N 55 006 773 600

Head office and registered address

99 Derby Road, Sunshine, Victoria 3020.
PO Box 147 Sunshine, Victoria 3020.

Customer Service 1300 303 330

Email au-custserv@britax.com

www.britax.com.au

NEW ZEALAND

Britax Childcare (NZ) Ltd.

Customer Service 0508 688 822

Email nz-custserv@britax.com

www.britax.co.nz

INTERNATIONAL ENQUIRIES

Contact your local Distributor.



The Safe-n-Sound trademark, ISOFLEX and product names are the property of Britax Childcare Pty. Ltd. (Australia).

The Britax trademarks is the property of Britax Childcare Holdings LTD, UK.

We reserve the right to alter this product without notice.

© 1995-2015 Britax Childcare Pty. Ltd. This product is covered by Australian and overseas Patent applications. Patents pending.