



Russell Hobbs



Bagless Vacuum Cleaner

RHF208P

INSTRUCTIONS & WARRANTY

RHF208P_IB_091013



Spectrum Brands Australia Pty Ltd

Locked Bag 3004 Braeside
Victoria 3195 Australia

Customer Service in Australia

TollFree: 1800 623 118
Email: info@spectrumbrands.com.au
Website: www.spectrumbrands.com.au

Spectrum Brands New Zealand Ltd

PO Box 9817 Newmarket
Auckland 1149 New Zealand

Customer Service in New Zealand

TollFree: 0800 736 776
Email: service@spectrumbrands.co.nz
Website: www.spectrumbrands.co.nz

Spectrum Brands Australia Pty Ltd and Spectrum Brands New Zealand Ltd Warranty Against Defects



In this warranty:

Australian Consumer Law means the Australian consumer law set out in Schedule 2 to the Competition and Consumer Act 2010;

CGA means the New Zealand Consumer Guarantees Act 1993;

Goods means the product or equipment which was accompanied by this warranty and purchased in Australia or New Zealand, as the case may be;

Manufacturer, We or **us** means:

1. for Goods purchased in Australia, Spectrum Brands Australia Pty Ltd ABN, 78 007 070 573;
or
2. for Goods purchased in New Zealand, Spectrum Brands New Zealand Ltd, as the case may be, contact details as set out at the end of this warranty;

Supplier means the authorised distributor or retailer of the Goods that sold you the Goods in Australia or in New Zealand; and

You means you, the original end-user purchaser of the Goods.

1. Our goods come with guarantees that cannot be excluded under the Australian Consumer Law, or the CGA. You are entitled to a replacement or refund for a major failure and compensation for any other reasonably foreseeable loss or damage. You are also entitled to have the goods repaired or replaced if the goods fail to be of acceptable quality and the failure does not amount to a major failure.
2. The benefits provided by this Warranty are in addition to all other rights and remedies in respect of the Goods which the consumer has under either the Australian Consumer Law or the CGA. The original purchaser of the Goods is provided with the following Warranty subject to the Warranty Conditions:
3. We warrant the Goods for all parts defective in workmanship or materials from the date of purchase (**Warranty Period**), for the period of:-
 - (a) Two (2) years for Russell Hobbs products (see product packaging for details)
 - (b) Two (2) years with five (5) year motor warranty for Russell Hobbs products (see product packaging for details)
 - (c) Limited Lifetime, Ten (10) years for Russell Hobbs cookware.
 - (d) One (1) year for George Foreman, iRobot, Westinghouse, Black & Decker and Spectrum Brands products.

If the Goods prove defective within the Warranty Period by reason of improper workmanship or material, we may, at our own discretion, repair or replace the Goods without charge.



Warranty Conditions

4. The Goods must be used in accordance with the manufacturer's instructions. This Warranty does not apply should the defect in or failure of the Goods be attributable to misuse, abuse, accident or non-observance of manufacturer's instructions on the part of the user. As far as the law permits, the manufacturer does not accept liability for any direct or consequential loss, damage or other expense caused by or arising out of any failure to use the Goods in accordance with the manufacturer's instructions.
5. Exhaustible components (such as batteries, filters and brushes) of the Goods are included under this Warranty only where there is a defect in workmanship or materials used.
6. The warranty granted under clause 3 is limited to repair or replacement only.
7. Any parts of the Goods replaced during repairs or any product replaced remain the property of the manufacturer. In the event of the Goods being replaced during the Warranty Period, the warranty on the replacement Goods will expire on the same date as for the Warranty Period on the original Goods which are replaced.
8. In order to claim under the warranty granted under clause 3 you must:
 - (a) Retain this warranty with your receipt/proof of purchase; and
 - (b) Return the Goods to us at the relevant address or to the Supplier by prepaid freight within the Warranty Period accompanied with (i) the legible and unmodified original proof of purchase, which clearly indicates the name and address of the Supplier, the date and place of purchase, the product name or other product serial number and (ii) this warranty.
9. This warranty is immediately void if:
 - (a) Any serial number or appliance plate is removed or defaced;
 - (b) The Goods have been serviced or otherwise repaired by a person not authorised to do so by us or where non approved replaced parts are used.
10. The Goods are designed for domestic use only. A limited 90-day Warranty applies to any industrial or commercial use of the Goods. The Goods must be connected to the electrical voltage requirements as specified in the ratings label located on the Goods.
11. This warranty does not cover the cost of claiming under the warranty or transport of the Goods to and from the Supplier or us.
12. This warranty is only valid and enforceable in Australia against Spectrum Brands Australia Pty Ltd and in New Zealand against Spectrum Brands New Zealand Ltd.

Contact us or the Supplier for further details.

Register your product online

If you live in Australia please visit: www.spectrumbrands.com.au/warranty

If you live in New Zealand Please visit: www.spectrumbrands.co.nz/warranty

Registration of your warranty is not compulsory, it gives us a record of your purchase AND entitles you to receive these benefits: Product information; Hints and tips; Recipes and news; Information on special price offers and promotions.

Any questions? Please contact Customer Service for advice.



Congratulations on the purchase of your Russell Hobbs appliance. Each unit is manufactured to ensure safety and reliability. Before using the appliance for the first time, please read the instruction booklet carefully and keep it for future reference. Pass it on if you pass on the appliance.

When using electrical appliances, basic safety precautions should always be followed.

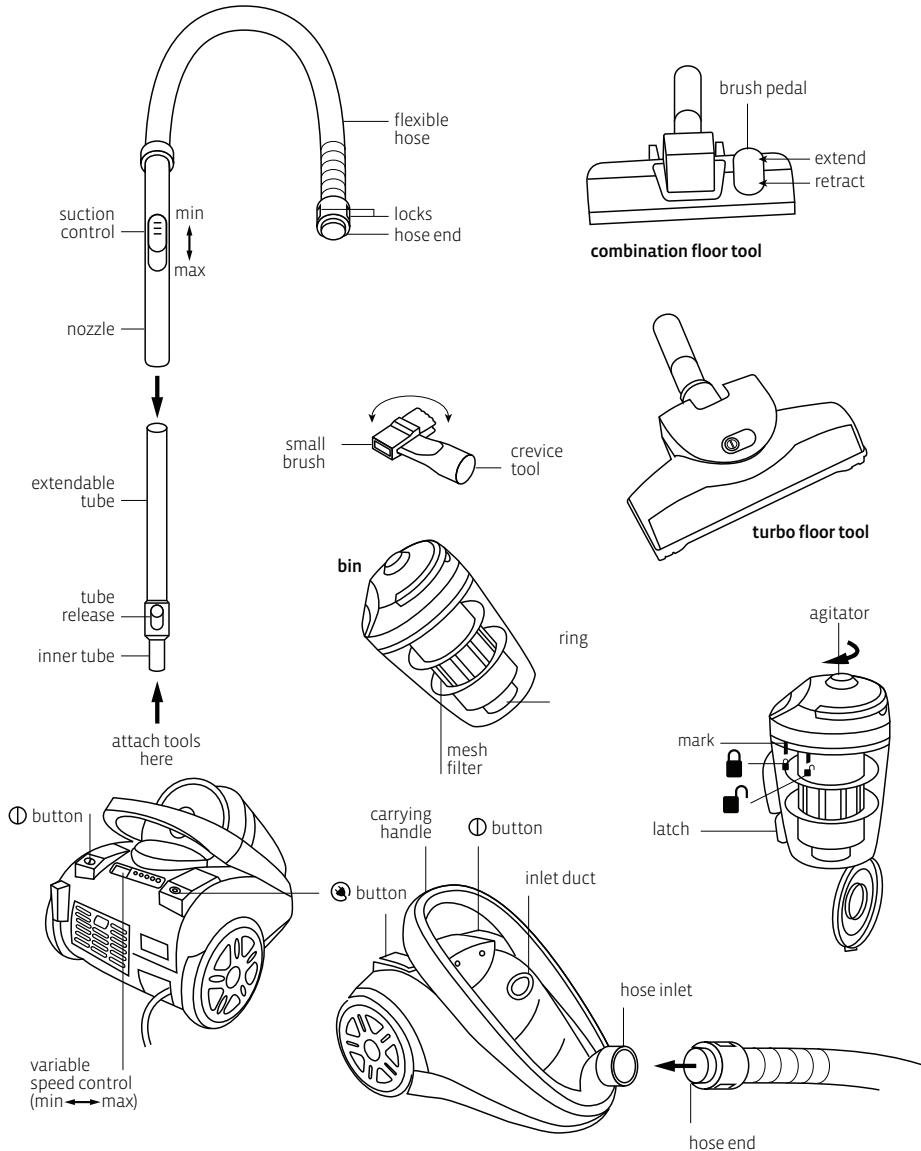



BEFORE USING FOR THE FIRST TIME

Check to confirm you have unpacked all of the components of your vacuum cleaner:

- Vacuum cleaner body
- Flexible hose
- Extendable tube
- Combination floor tool
- Crevice tool with small brush
- Turbo floor tool

FITTING THE HOSE

- Push the hose end into the inlet. You will hear a click as it locks into position.
- Give it a gentle tug to check it is properly locked.

POWER CORD

- Pull as much cable as you need from the back of the cleaner.
- A yellow band around the cable will appear when there is approximately one metre of cable left.
- Stop pulling when the red band around the cable appears. This indicates that you are approaching the cable limit.

CAUTION: Avoid extending the power cord past the red band. Pulling beyond this may result in damage to the cord connection.

- When vacuuming larger spaces and multiple rooms you may need to turn the vacuum off and select another power outlet.
- Avoid tangling the power cord around furniture and other obstacles as it may become a tripping hazard to you and other people.

CARRYING AND MOVING THE CLEANER



- Lift the cleaner only by the carrying handle.
- Do not sit it upright as it will fall over.
- The vacuum cleaner should follow you as you vacuum. If you feel resistance, check the vacuum or power cord is not tangled or caught. Pulling the vacuum under stress by the hose will cause the hose to stretch and can damage the hose connection and power cord.

TUBES

- Fit the extendable tube to the nozzle for floors, carpets or hard to reach places.
 - a) Push the tube release in the direction of the arrows on the release button and keep it pressed.
 - b) Pull out as much of the inner tube as you need and then release the button; it is best to retract the tube for storage.
- Push the wide end of the extendable tube on to the nozzle. Choose a tool and push it onto the narrow end of the tube.

CHOOSE THE TOOL FOR THE JOB

- The combination floor tool, turbo floor tool and crevice tool/small brush will fit on the nozzle or on the end of the extendable tube. The extendable tube fits on the end of the nozzle.
- The combination floor tool is usually used with the extendable tube for floors and carpets.
 - Press the rear of the brush pedal to extend the bristles for hard floor coverings such as vinyl, tiles and timber.
 - Press the front of the brush pedal to retract the bristles for soft floor coverings such as rugs and carpets.
- The turbo brush is normally used with the extendable tube for floors and carpets.

Slide the tab on top of the brush to  for floors without carpet or carpet with short pile. Slide it to  for rugs and long pile carpets.





- The crevice tool can be used with or without the extender tube and can be used to remove pet hair, lint and dust from awkward, hard to reach places.

Note: The small brush is part of the crevice tool. To store it, turn it back, parallel to the crevice tool.

SUCTION CONTROL

- Different carpets/surfaces may require different levels of suction. For example, you may find the floor tool suction is too strong on a tight loop-pile carpet causing the tool to grip the surface and push surface debris along. In this instance, reducing the suction by opening the nozzle suction control will allow the floor tool to glide more easily over the carpet surface.

There are two suction controls on this vacuum cleaner:

- a) Use the nozzle suction control to reduce the grip the tools apply to the surfaces being cleaned. Move it away from the nozzle end to reduce suction or move towards the nozzle end for maximum suction.
- b) Use the variable speed control to reduce the suction power and volume of air being drawn into the vacuum. Use this when cleaning more delicate materials such as drapes. Slide the control towards the cord rewind button  to increase suction power; slide it towards the on/off  button to decrease suction power.

PLUG IN

Caution: If you have accidentally pressed the power on/off button , the vacuum cleaner will come on when you plug it in.

- Plug the power cord into a wall power outlet near the area to be cleaned, and switch the power on.

SWITCHING ON

- Press and release the power on/off  button to turn the cleaner on.

CLEANING

- Move the tool over the surface, cleaning a small area at a time.
- When you move to a new area, overlap the previous area to make sure none of the surface is missed.

SWITCHING OFF

- If you would like to change tools or if you have finished vacuuming, press and release the power on/off button  to turn the cleaner off.

FINISHED CLEANING?

- Switch the power off and remove the plug from the wall power outlet.
- Stand clear of the cord, press and hold the cord rewind button .
- Keep clear of the cord, as it rewinds quite quickly and can flick up or catch on corners and furniture. If the cord does catch on an object, release the rewind button and it will discontinue rewinding.
- If the power cord does not retract fully into the unit you may need to pull it out a little, and then press and hold the cord rewind button again. You may need to push the plug end into the storage area manually.

REMOVING AND EMPTYING THE BIN

- In order to maintain maximum performance, empty the dustbin after each use.

The cleaner will continue to work until the dustbin is full, but you may find a loss of performance as it nears capacity.

- Switch the power off, remove the plug from the wall power outlet, and leave for a minute to allow the dust settle.
- Lift the bin handle and pull the bin upwards out of the cleaner.
- Lower the dust bin into your rubbish bin so the bottom of the dust bin is below the rim. This prevents dust dispersing into the air.



- Alternatively, spread some newspaper on the floor.
- Press the latch and the bottom of the dustbin will drop open dumping the contents into the rubbish bin, or onto the newspaper.
- Do not tap the open dustbin on the sides of your rubbish bin as this could result in damage to the dustbin.
- Turn the agitator on top of the bin back and forth several times to agitate the inside of the HEPA filter. This releases excess any dust that might be held in its folds.
- Lift the bottom of the bin up to close it.

CHECK THE FILTERS



- While emptying the bin, check the filters – blocked filters quickly reduce suction.
- You can see the mesh filter through the side of the bin. You should be able to see the HEPA filter through the mesh filter.
- If either filter looks clogged or dirty or if you cannot see the HEPA filter clearly, it is time to clean both filters.
- If they do not need cleaning, refit the bin in the cleaner – put the bottom in first, then gently push the top down into position. You will hear the locks click into place.
- Check that it is secure.

CLEANING THE VACUUM CLEANER

- Before cleaning, switch the power off and remove the plug from the wall power outlet.
- Do not put any part of the cleaner in a dishwasher.
- Do not use harsh or abrasive cleaning agents or solvents.
- Wipe external surfaces with a damp cloth. A dab of washing-up liquid will remove stubborn stains.
- Wipe the tools with a damp cloth or hand wash in warm soapy water. Rinse under a running tap to remove all traces of soap, then let air dry – do NOT refit until they are completely dry.
- Wipe the extendable tube and hose with a damp cloth. Check they are dry before refitting. Do not put them in water, you will damage them.
- Wash the dust bin in warm soapy water with a soft cloth or sponge (remove all filters first). Rinse to remove all traces of soap, then let it air dry – do NOT refit until it is completely dry.

CLEANING THE FILTERS

While emptying the dust bin, check the filters – blocked filters quickly reduce suction. Make sure the space you are using is protected with an old towel or some newspaper as this process can be messy.

- Grip the bin lid with one hand, grip the bin with the other, and turn the lid of the bin to move the  mark on the lid from the  around to the .
- Lift the lid and filter assembly out of the bin and turn them upside down.
- Turn the filter assembly clockwise to unlock it

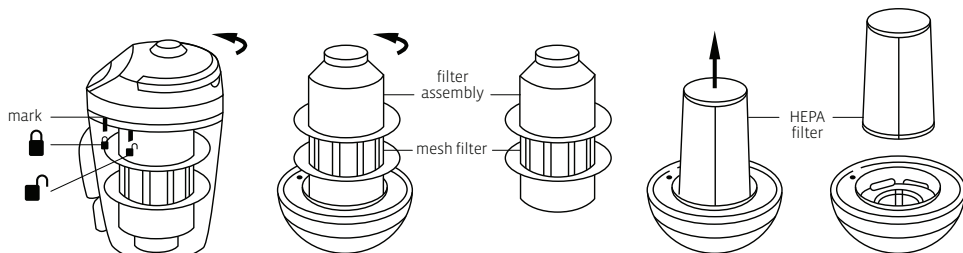





THE MESH FILTER

- Wash the filter assembly (contains mesh filter) in warm soapy water.
- Leave it to air dry – do NOT refit it until it is completely dry.

THE HEPA FILTER

- The HEPA filter is responsible for cleaning the return air and requires careful handling.
- If the filter is covered in dust, tap it gently over some newspaper or on the rim of a rubbish bin to dislodge the dust.
- If it is very dirty, soak it in warm soapy water for a few minutes, rinse under a running tap, remove all traces of soap, then let it air dry – do NOT refit until it is completely dry.

REASSEMBLY

- Wait until everything is completely dry before reassembly.
- Lower the HEPA filter into the lid, locating the spindle into the bottom of the agitator. Make sure it is fully seated in the lid – it may be necessary to turn it a bit to clear the lugs inside the lid.
- Lower the filter assembly over the HEPA filter, then turn it anti-clockwise to lock it into the lid (it is a bayonet-type fitting).
- Turn the combined lid and filter assembly upside down.
- Align the mark on the lid with the (insert image unlock)marked on the bin.
- Lower the lid and filter assembly into the bin.
- Grip the bin lid with one hand, grip the bin with the other, and turn the lid of the bin to move the  mark on the lid from the (insert image for unlock) on the bin round to the .
- Replace the bin in the cleaner – put the bottom in first, then push the top home. You will hear the locks click into place.
- Check that it is secure.

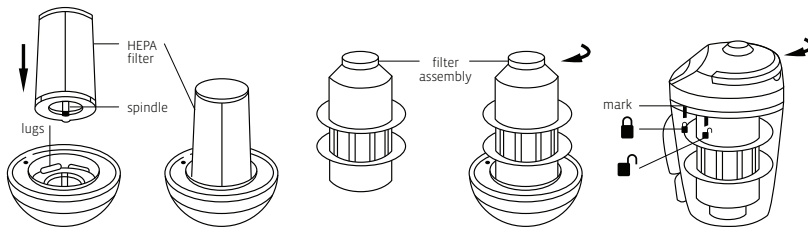

CHECK THE OUTLET FILTER

- The outlet filter is located on the back of the vacuum cleaner.
- Press the lock down, pull the top of the cover away from the cleaner and lift the cover up and off the cleaner.
- Ease the outlet filter out of the cleaner.
- If the filter is covered in dust, tap it gently over some newspaper or on the rim of a rubbish bin to dislodge the dust.
- If it is very dirty, soak it in warm soapy water for a few minutes, rinse under a running tap, remove all traces of soap, then let it air dry – do NOT refit until it is completely dry.
- When it is dry, replace it in the rear of the cleaner.
- The soft foam side of the filter should be towards the cover and the firm white side of the filter should be towards the cleaner.
- Fit the lugs on the bottom of the cover into the slots in the cleaner and push the top of the cover into the cleaner until it clicks into place

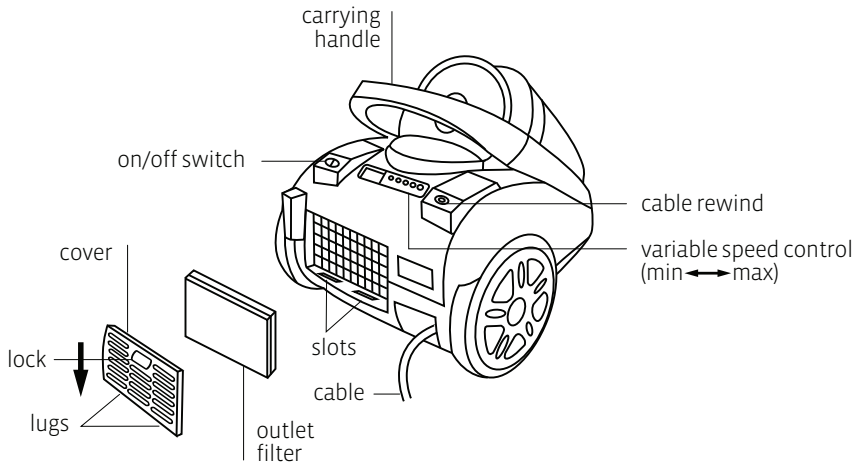

BLOCKAGES

If the cleaner starts to get noisy and you start to lose suction there is possibly a blockage.

- Switch the power off and remove the plug from the wall power outlet.
- Spread some newspaper or an old towel on the floor to avoid making a mess.
- If you are using one of the tools, remove and check it first.
- Remove the hose and check it – leave it disconnected until you have completed the next steps.
- Remove the dust bin and check both ends of the inlet duct for any blockages.
- If there is a blockage, try and remove it with your hands. Do not use anything sharp.
- Check all the filters.
- Then reassemble.

Note: If you have not cleared the blockage following these steps, please ring customer service.

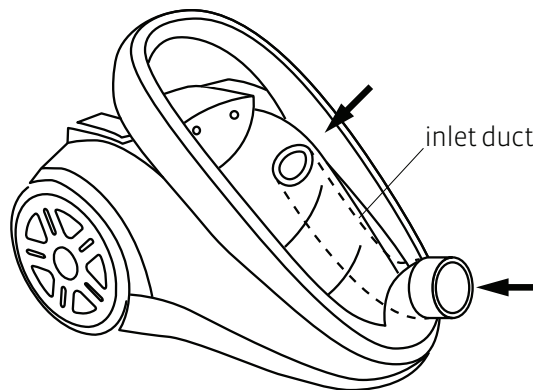



IMPORTANT SAFEGUARDS

When using electrical appliances, basic safety precautions should always be followed, including:

1. The cleaner must only be used by or under the supervision of a responsible adult. Use and store it out of reach of children.
2. This appliance is NOT a toy. Children should be supervised to ensure they do not play with this appliance.
3. This appliance is not intended for use by persons (including children) with reduced physical, sensory or mental capabilities, or lack of experience and knowledge, unless they have been given supervision or instruction concerning use of the appliance by a person responsible for their safety.
4. Do not immerse the cleaner in any liquid and do not use it anywhere damp or wet.
5. Do not use the cleaner near a gas, oil (including paraffin) or open fire. The flame may be drawn towards the cleaner causing a fire hazard.
6. To avoid personal injury, keep hair, clothing, fingers, face, etc. away from the brush/ suction inlet of the cleaner.
7. Do not use the cleaner to pick up any of the following:
 - **do not attempt to pick up liquid** – this cleaner is designed for dry substances only.
 - **do not pick up items that may ignite spontaneously** – e.g. matches, pieces of firelighter.
 - **do not pick up anything burning or smouldering** – e.g. cigarette ends, ashes or embers.
 - **do not pick up spillage from toner cartridges** – the fine carbon particles may pass through the filter, short circuit the motor and burn it out.
 - **do not pick up cement or plaster dust** – these can combine with moisture in the air, clog the filter, scour the bin and possibly cause the motor to overheat and burn out.
 - **do not pick up sharp objects** – they may pierce the filter and damage the motor.
 - **do not pick up biological waste** – you will eventually have to clean it off the filter and there is a possibility of viral particles passing through the filter and entering your air supply.
8. If using the cleaner outdoors (e.g. cleaning the car), connect it to a power outlet that is protected by a safety switch.
9. Do not leave the cleaner unattended when plugged in.
10. To prevent damage to the power cord, avoid catching, stressing or running over the cord while vacuuming.
11. Be sure the power cord does not become a tripping hazard to you or others while vacuuming.
12. If using the cleaner to vacuum stairs, place the cleaner to avoid falling and be sure to work above the cleaner to avoid injury should the unit fall.
13. Do not use the cleaner to vacuum people, pets or animals of any sort.
14. Unplug the cleaner and retract the cord when not in use.
15. Do not use the cleaner for any purpose other than those described in these instructions.
16. Use only the accessories supplied with the unit.
17. Do not leave the cleaner sitting in sunlight. Prolonged exposure to UV rays may damage the plastic.
18. Do not operate this appliance with a damaged cord/plug or after the appliance has malfunctioned, or been dropped or damaged in any manner. Contact Customer Service for replacement, examination, repair or adjustment.
19. There are no user serviceable parts other than the filters and external attachments/ accessories. If the power cord is damaged, it must be replaced by the manufacturer or similarly qualified person in order to avoid hazard.
20. For added safety, electrical appliances should be connected to a power outlet that is protected by a residual current device (RCD), also often referred to as a 'Safety Switch'. Your switchboard may already incorporate an RCD. If unsure, call an electrician for verification and fitting if necessary.

SAVE THESE INSTRUCTIONS. THIS APPLIANCE IS FOR HOUSEHOLD USE ONLY



Russell Hobbs

www.russellhobbs.com.au

www.russellhobbs.co.nz

