



OWNER'S MANUAL

SXS

REFRIGERATOR

Please read this owner's manual thoroughly before operating and keep it handy for reference at all times.

Table of contents

Introduction	Entry	3
	Basic safety precautions	3
	Identification of parts	11
Installation	Where to install	12
	Door removal	13
	Door replacement	14
	Feed water pipe installation	14
	Height adjustment	15
Operation	Starting	17
	Adjusting the temperatures and functions	17
	Adjusting The Temperatures And Display	18
	Operating The Dispenser	19
	Setting The Functions	20
	Shelf	24
	Egg box	24
	Nano charcoal deodorizer	24
	Fresh compartment	25
	Vacuum fresh compartment	26
	Freezer/Fridge basket	27
	Dairy corner	27
	How to exchange the water purifier filter	28
Suggestion on food storage	Location of foods	29
	Storing foods	30
Care and maintenance	General information	31
	Cleaning	31
	Trouble shooting	32
	It is normal...	37



- This product is for exclusive use on 240V/50Hz.
- You will need to purchase a transformer of more than 2.0KVA if you wish to use this product on another supply voltage, e.g. 110V.

Entry

The model and serial numbers are found on the inner case or back of refrigerator compartment of this unit. These numbers are unique to this unit and not available to others. You should record requested information here and retain this guide as a permanent record of your purchase. Staple your receipt here.

Date of purchase : _____
 Dealer purchased from : _____
 Dealer address : _____
 Dealer phone no. : _____
 Model no. : _____
 Serial no. : _____

Basic safety precautions

This guide contains many important safety messages. Always read and obey all safety messages.



This is the safety alert symbol. It alerts you to safety messages that inform you of hazards that can kill or hurt you or others or cause damage to the product. All safety messages will be preceded by the safety alert symbol and the hazard signal word DANGER, WARNING, or CAUTION. These words mean:



DANGER

You will be killed or seriously injured if you don't follow instructions.



WARNING

You can be killed or seriously injured if you don't follow instructions.



CAUTION

Indicates an imminently hazardous situation which, if not avoided, may result in minor or moderate injury, or product damage only.

All safety messages will identify the hazard, tell you how to reduce the chance of injury, and tell you what can happen if the instructions are not followed.

WARNING

To reduce the risk of fire, electric shock, or injury to persons when using your product, basic safety precautions should be followed, including the following. Read all instructions before using this appliance.

1. When connecting the power

A dedicated outlet should be used.

- Using several devices at one outlet may cause fire.
- If unit is connected to an earth leakage breaker it may trip resulting in spoiled food.

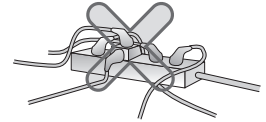

Do not allow the power plug to face upward or to be crushed at the back of the refrigerator.

If the cord is crushed behind the refrigerator it may damage the cable resulting in fire. An upward facing plug may pull loose under the weight of the cord resulting in electrical failure causing fire or the fridge turning off and spoiling food.

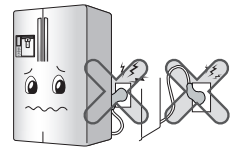

Prevent the power cord from being crushed or kinked if the refrigerator is pushed in after the power plug is extracted during the installation.

When moving your appliance away from the wall, be careful not to roll over the power cord or to damage it in any way.

Crushed or kinked cables can become the cause of fire or electric shock.

Do not allow heavy objects to kink or crush the power cord.

It may damage the power cord and become a cause of fire or electric shock.

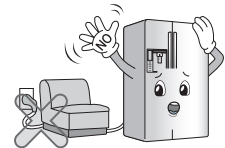

Do not extend or modify the length of the power plug.

This may become the cause of fire or electric shock.

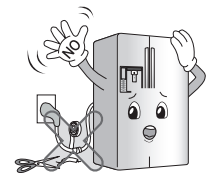

Unplug the power plug when cleaning, handling or replacing the interior lamp of the refrigerator.

- It may cause electric shock or injury.
- When replacing the interior lamp of the refrigerator, make sure that the insulating rubber ring within the socket is not taken off.

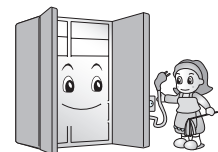

Do not pull out the cord or touch the power plug with wet hands.

It may cause electric shock or injury.

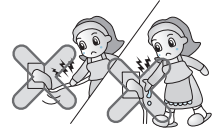

Remove water or dust from the power plug and insert it with the ends of the pins securely connected.

Dust, water or unstable connection may cause fire or electric shock.

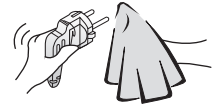

Unplug the power cord from the power outlet for cleaning or other requirements.

It may cause electric shock or injury.

Do not disconnect by pulling on the cord. Always disconnect by grasping and pulling on the plug top.

Pulling on the cable may damage the cable resulting in electric shock or fire.



Make sure of grounding.

Consult a qualified electrician or service person if the grounding instructions are not completely understood, or if you have doubts on whether the appliance is properly grounded.

Incorrect grounding may lead to electric shock in the event of a breakdown.

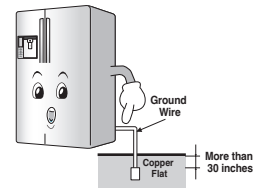

Always have unit grounded in accordance with local regulations.

Be sure to use a properly grounded extension lead if an extension lead must be used.

If incorrectly grounded it may become the cause of a fire.

When the power cord or the power plug is damaged or the holes of the outlet are loosed, do not use them.

It may cause electric shock or be the cause of a fire.

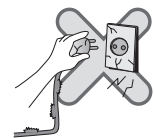

Wait for 5 minutes or longer when reconnecting the plug.

It may cause the operation of the refrigerator to fail.



If the supply cord is damaged, it must be replaced by the manufacturer or its service agent or a similarly qualified person in order to avoid a hazard.

2. When using the refrigerator

Do not place heavy objects or liquid filled objects on the top of the refrigerator.

Heavy objects may fall when opening and closing doors resulting in injury. Liquid filled objects may leak or fall and break resulting in injury, or electric shock.



Do not install the refrigerator in a damp or wet environment.

Moisture may penetrate electrical components resulting in fire or electric shock.

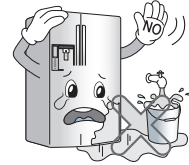

Do not lean on or hang from the doors or shelves of the refrigerator.

This may damage the doors or shelves of the refrigerator or cause it to topple over resulting in injury and damage. Always supervise children when they are near the refrigerator.

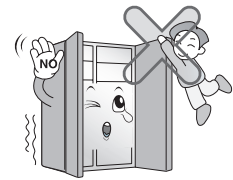

Prevent children from entering the product.

It may endanger the life of a child if the child enters the refrigerator.

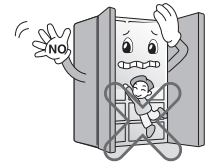

Take care when opening and closing the refrigerator doors. Vigorous opening or closing may cause the contents to topple out resulting in injury or damage.

Do not store or use inflammable materials in or around the refrigerator.

It may become the cause of an explosion or fire.

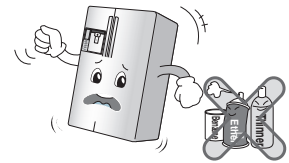

Do not use or place heated or flame based scented products (Such as scented candles or incense burners) in the fridge to deodorise.

It may become the cause of an explosion or fire.

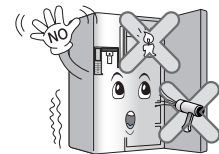

Do not store medicine or academic materials at the refrigerator.

If materials with strict temperature restrictions are stored they may deteriorate or react undesirably resulting in possible harm or risk.

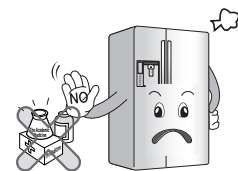

Do not use any combustible spray near the refrigerator.

It may become the cause of an explosion or fire.

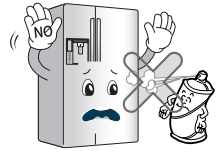
**Install in places away from the heat sources such as fireplaces, heaters and ovens. Pay particular attention to avoid locating near gas related products.**

It may become the cause of an explosion or fire.

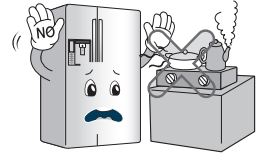
**Do not place flower vases, cups, cosmetics, medicine or any container with water on the refrigerator.**

It may fall, leak or spill resulting in possible electric shock or fire.

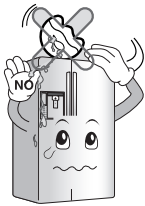
**In case of a heavy electrical storm or if unit is not to be used for a long period of time, disconnect the power plug.**

There is a possibility for electrical damage. This may lead to an electric shock or fire.

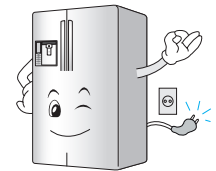
**DO NOT use a water damaged unit until it has been certified safe by a licensed electrician or similarly qualified person.**

It may be the cause of an electric shock or fire.

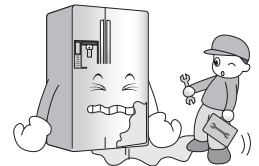
**If a gas leak is detected, do not touch the refrigerator or the outlet and ventilate the room immediately.**

- Any spark may result in an explosion or fire.
- Because this refrigerator uses natural gas (isobutene, R600a) as the environment-friendly refrigerant, even a small amount (80~90g) is combustible. If a gas leak occurs due to severe damage during delivery, installation or use of refrigerator, a spark may cause a fire.

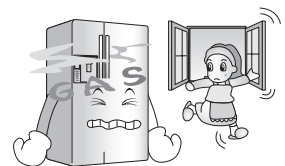

Do not spray water on either the inside or outside of the refrigerator. Do not use alcohol or mineral based cleaners on the refrigerator (such as Benzene or Thinners).

These may deteriorate or penetrate the insulation or electrical components resulting in possible electric shock, fire or damage to refrigerator.

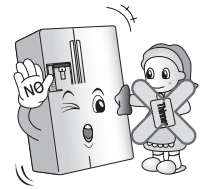

When any strange smell or smoke is detected from the refrigerator, disconnect the power plug immediately and contact to the service center.

Continuing to run unit may result in damage or fire.

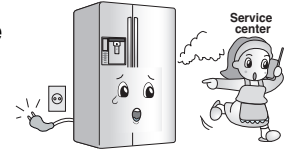

Do not allow any person except a qualified engineer to disassemble, repair or alter the refrigerator.

It may cause injury, electric shock or fire.

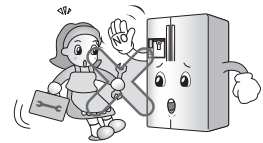

Do not use the fridge-freezer for non-domestic purposes (storing medicine or testing material, or use in a mobile application.)

It may cause an unexpected risk such as fire, electric shock, deterioration of stored material or chemical reaction.

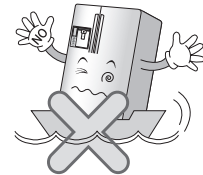

When disposing the refrigerator, remove the doors from the refrigerator but leave the shelves in place so that children may not easily climb inside.

Failure to do so may cause a child to become trapped inside.



This appliance is not intended for use by persons (including children) with reduced physical, sensory or mental capabilities, or lack of experience and knowledge, unless they have been given supervision or instruction concerning use of the appliance by a person responsible for their safety.

Children should be supervised to ensure that they do not play with the appliance.

Install the refrigerator on a solid and level floor.

Installing it in an unstable place may cause death by the refrigerator falling down when opening or closing the door.

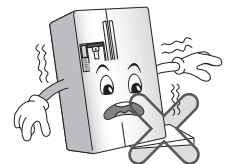

Do not insert hands or a metal object into the exit of cool air, the cover, the bottom of the refrigerator, the heatproof grill (exhaust hole) at the back.

It may cause electric shock or injury.

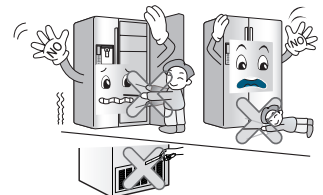

Keep ventilation openings, in the appliance enclosure or in the built-in structure, clear of obstruction.

Do not use mechanical devices or other means to accelerate the defrosting process, other than those recommended by the manufacturer.

Do not damage the refrigerant circuit.

Do not use electrical appliances inside the food storage compartments of the appliance, unless they are of the type recommended by the manufacturer.

The refrigerant and insulation blowing gas used in the appliance require special disposal procedures. When disposal, please consult with service agent or a similarly qualified person.



This appliance contains a small amount of isobutane refrigerant (R600a), natural gas with high environmental compatibility, but it is also combustible. When transporting and installing the appliance, care should be taken to ensure that no parts of the refrigerating circuit are damaged. Refrigerant squirting out of the pipes could ignite or cause an eye injury. If a leak is detected, avoid any naked flames or potential sources of ignition and air the room in which the appliance is standing for several minutes.

In order to avoid the creation of a flammable gas air mixture if a leak in the refrigerating circuit occurs, the size of the room in which the appliance may be sited depends on the amount of refrigerant used. The room must be 1m² in size for every 8g of R600a refrigerant inside the appliance. The amount of refrigerant in your particular appliance is shown on the identification plate inside the appliance. Never start up an appliance showing any signs of damage. If in doubt, consult your dealer.

CAUTION

Violating this direction may cause injury or damage to house or contents. Always be careful, please.

Do not insert the hands into the ice bucket or the ice dispenser.

Operating the ice maker may cause injury.



Do not touch food or containers in the freezer with wet hands.

It may cause frostbite.

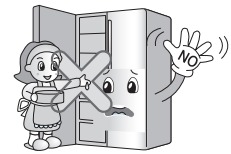

Do not dispense ice into thin crystal or ceramic ware.

It may break cup or ceramic ware and cause injury.

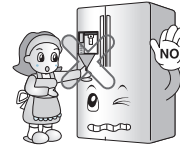

If the electricity is removed (e.g. Power failure) for an extended period of time, remove ice from ice bucket. (only for the model with the dispenser).

A Long term power failure may cause the ice in the ice bucket to thaw spilling water onto the floor causing damage.

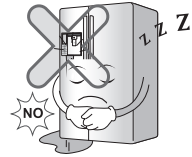

Supply the refrigerator with drinkable water only (only for the model with the dispenser).

If supplied with non drinkable water may result in a health risk.

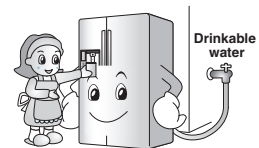

Do not remove the cover of the automatic ice maker. (Only for the models with automatic ice maker)

The mechanical operation of the ice maker may cause injury.

Ensure that all foods and containers are stored or stacked in a stable manner.

The food may fall during opening and closing of the door of the refrigerator and hurt people.

Do not put filled bottles in the freezer.

It may freeze the contents and break the bottle possibly resulting in injury.



Do not insert hands into the bottom of the refrigerator.

The iron plate at the bottom may cause injury.



Carry the fridge-freezer with the handles at the bottom of the front and the top of the rear.

Otherwise, your hands may slip possibly resulting in injury or product damage. Because the product is heavy, carrying it alone may hurt people or accidents may occur.

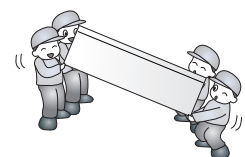

Because opening or closing the door or the home bar of the refrigerator may cause injury to other people around it, be careful, please.

Open doors could result in children being hurt by the corners of the doors (particularly the home bar door as edge might be out of line of site).

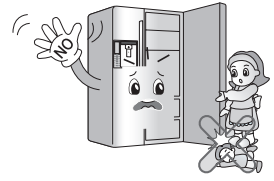

Do not put any living animal in the refrigerator.

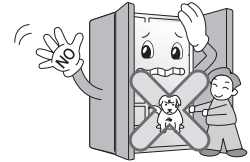

Identification of parts

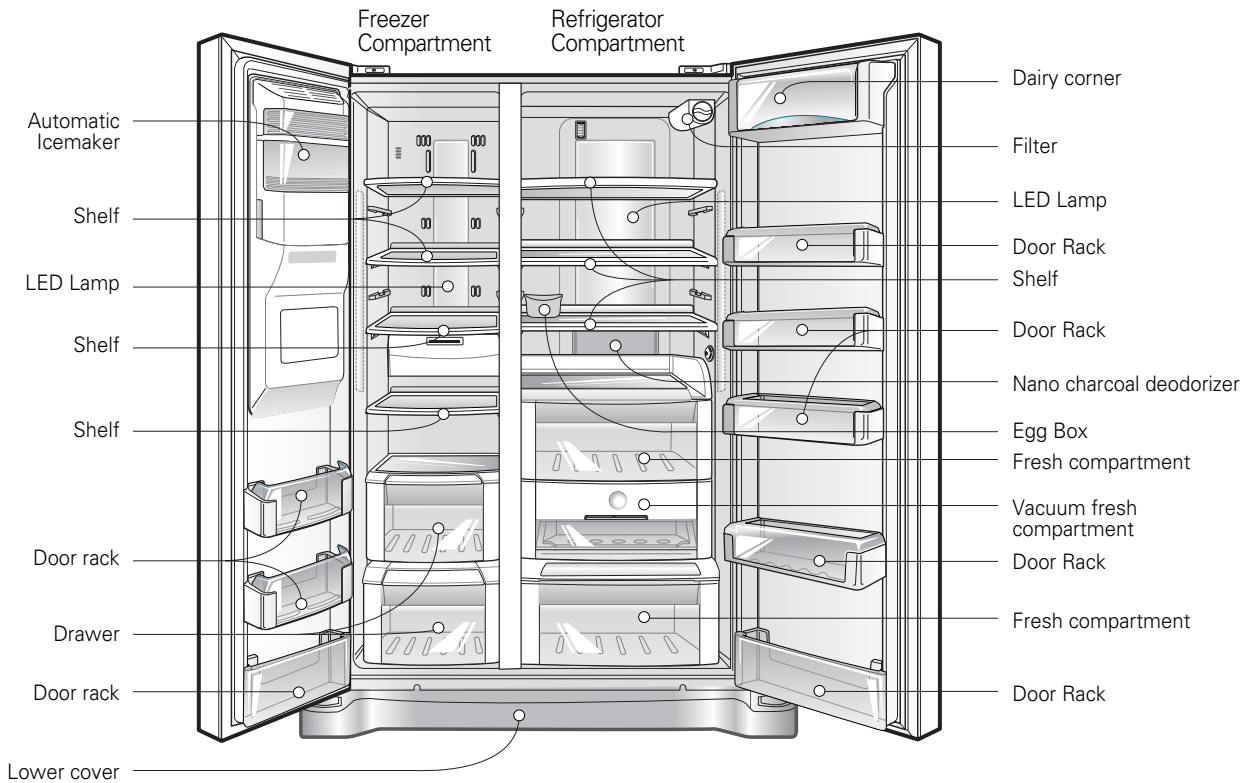

NOTE
 • Parts, features, and options vary by model. Your model may not include every option.

Where to Install

Select a good location

1. Place your appliance where it is easy to use.
2. Avoid placing the unit near heat sources, direct sunlight or moisture.
3. To ensure proper air circulation around the fridge-freezer, please maintain sufficient space on both the sides as well as top and maintain at least 2 inches (5 cm) from the rear wall.
4. To avoid vibrations, the appliance must be leveled.
5. Don't install the appliance below 5°C. It may affect the performance.

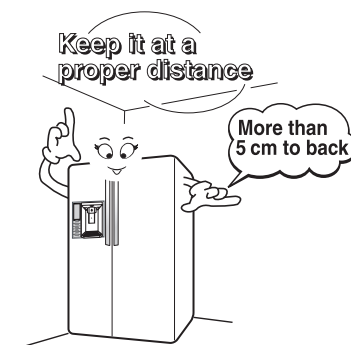

Disposal of the old appliance

This appliance contains fluid (refrigerant, lubricant) and is made of parts and materials which are reusable and/or recyclable. All the important materials should be sent to the collection center of waste material and can be reused after rework (recycling). For disposal please contact your local recycling center.

WARNING

Remove lower cover and then feed water tube

Remove the freezer compartment door

Remove the refrigerator door

Door removal

Electric Shock Hazard

Disconnect electrical supply to refrigerator before installing. Failure to do so could result in death or serious injury.

If your access door is too narrow for the refrigerator to pass through, remove the refrigerator door and pass the refrigerator laterally.

Remove the lower cover by lifting upward and then pull up the feed water tube while pressing area ① shown in the figure to the right.

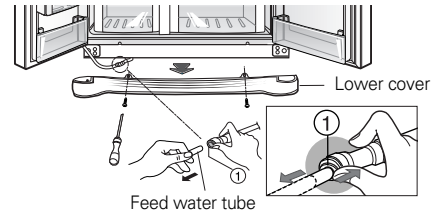

NOTE

- If a tube end is deformed or abraded, cut the part away.

- 1) Removing the hinge cover by loosening the screws. Separate all connection wires leaving the earth wire till last.

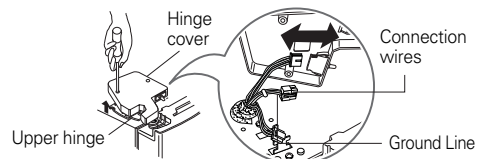

- 2) Remove the keeper by rotating it counter clockwise (①) and then lifting the upper hinge up (②).

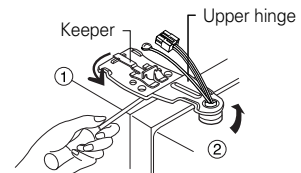

NOTE

- When removing the upper hinge, be careful that the door does not fall forwards .

- 3) Remove the freezer compartment door by lifting it upward. This time, the door should be lifted enough for the feed water pipe tube to be completely pulled out.

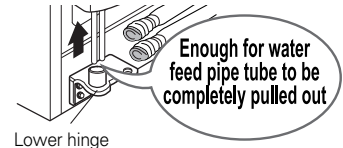

NOTE

- Once the door has been removed, lay it down carefully inside paying careful attention not to damage water feed pipe.

- 1) Loosen the hinge cover screws and remove the cover. Remove connection wire, if any, leaving the earth wire till last.

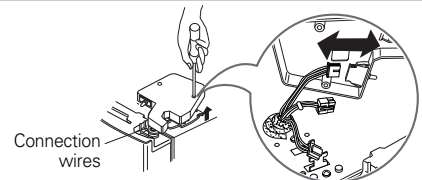

- 2) Remove keeper by rotating it clockwise (①) and then remove the upper hinge by lifting it up (②).

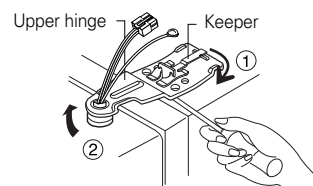

- 3) Remove the refrigerator compartment door by lifting it up.

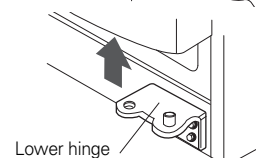

Pass the refrigerator

Pass the refrigerator laterally through the access door as shown in the right figure.

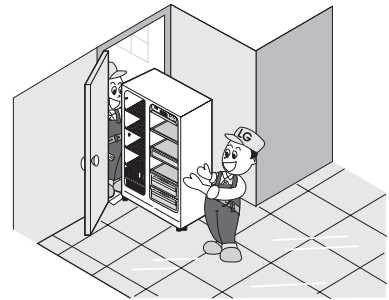
**Door replacement**

Mount them in the reverse sequence of removal after they pass through the access door.

Feed water pipe installation**Before installation**

- Automatic ice maker operation needs water pressure of 147~834 kPa (1.5~8.5 kgf/cm²) (That is, an instant paper cup (180 cc) will be fully filled within 3 sec.).
- If water pressure does not reach the rating 147 kPa (1.5 kgf/cm²) or higher, it is necessary to purchase a separate pressure pump for normal automatic ice making and cool water feed.
- Keep the total length of the feed water pipe tube within 8 m and be careful not to bend to sharply or kink tube. If the tube is 8 m or longer it may cause trouble in water feed owing to the drain water pressure.
- Ensure the feed water pipe is not installed close to any heat source.

! WARNING

- Connect to drinkable water supply only.
- Refer to instructions with water filter kit for installation.

Height adjustment

When the floor is not leveled

- When the height of the door may not be leveled when the floor is not leveled.

► When the freezer door is lower – ①

Use the (-) driver or spanner to turn the groove or nut of the height adjustment screw on the left to the counterclockwise direction to level the door.

► When the fridge door is lower – ②

Use the (-) driver or spanner to turn the groove or nut of the height adjustment screw on the right to the clockwise direction to level the door.

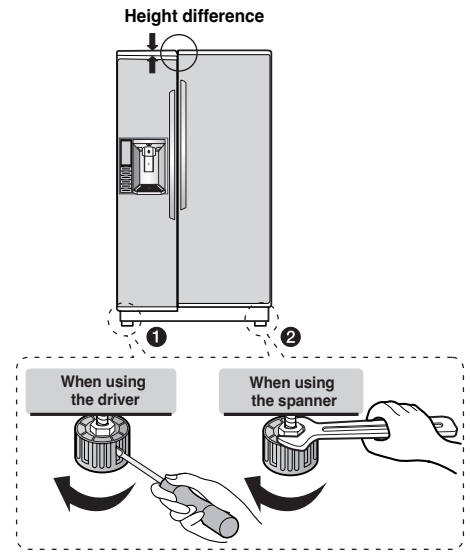

When the fridge door is lower than the freezer door

► When the fridge door is lower than the freezer door while using the refrigerator, level the doors.

1. Use the ③ tool for adjustment on the wide side to turn nut ① (↻) in the clockwise direction to loosen the keeper nut.
2. Use the ③ tool for adjustment on the narrow side to turn the adjustment hinge pin ② in (↻) clockwise direction or (↺) counterclockwise direction to adjust the height of the fridge and freezer doors.

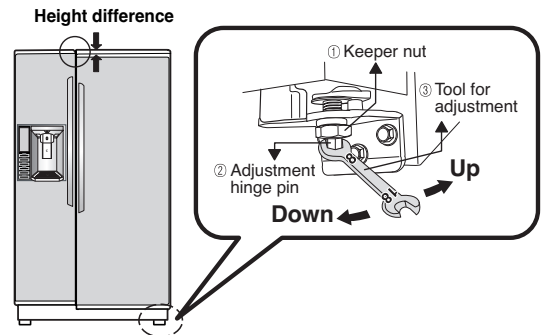

3. After aligning the height of the door, turn the keeper nut in counterclockwise direction tightly.

⚠ CAUTION

Do not force too hard to level the height. The hinge pin can be pulled out. (Adjustable range of height is a maximum of 2" (5 cm))

After leveling the door height

The refrigerator doors will close smoothly by heightening the front side by adjusting the height adjusting screw. If the doors do not close correctly, performance may be affected.

Next

1. Wipe off all dust accumulated during shipping and clean your appliance thoroughly.
2. Install accessories such as the ice cube box, cover evaporating tray, etc., in their proper places. They are packed together to prevent possible damage during shipping.
3. Connect the power supply cord (or plug) to the outlet. Don't double up with other appliances on the same outlet.

HANDLE REMOVAL

To move the refrigerator through a house door, it may be necessary to remove the refrigerator door handles.

NOTE

- Handle appearance may vary from illustrations on this page.

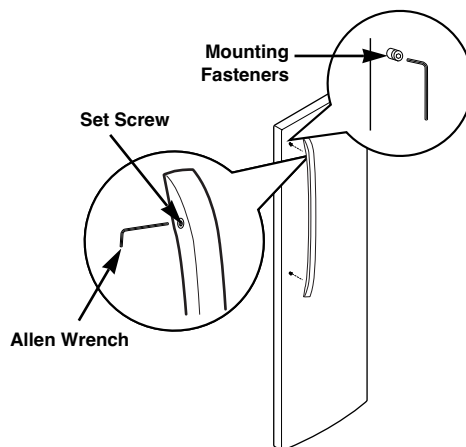

Loosen the set screws with a 2.5 mm (3/32") Allen wrench and remove the handle.

NOTE

- If the handle mounting fasteners need to be tightened or removed, use a 1/4" Allen wrench.

HANDLE REINSTALLATION

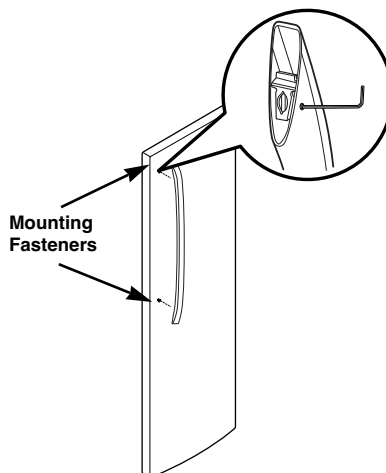

Place the handle on the door by aligning handle footprints to fit mounting fasteners and tighten the set screws with a 2.5 mm (3/32") Allen wrench.

NOTE

- If the handle mounting fasteners need to be tightened or removed use a 1/4" Allen wrench

Starting

When your refrigerator is first installed, allow it to stabilize at normal operating temperatures for 2-3 hours prior to filling it with fresh or frozen foods. If operation is interrupted, wait 5 minutes before restarting.

Adjusting the temperatures and functions

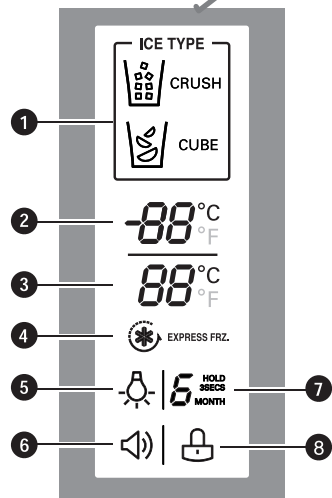
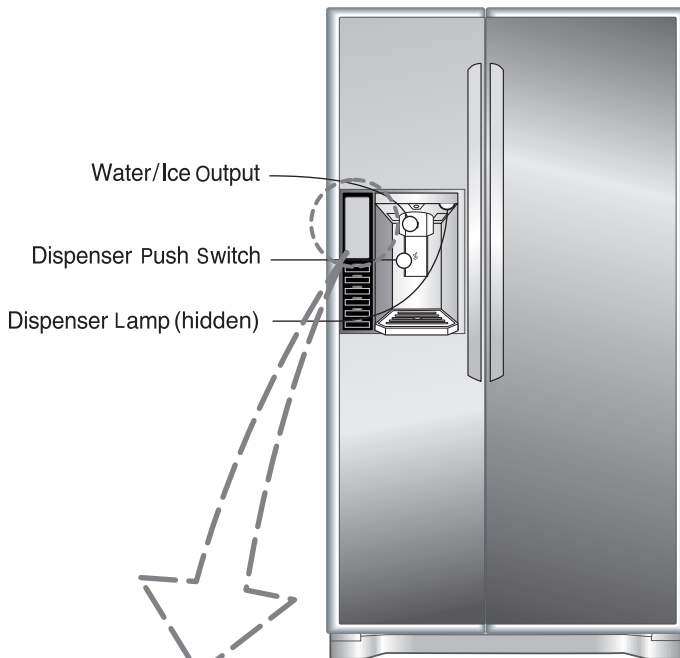

1 DISPENSER SELECTION INDICATOR

Shows Cubed ice or Crushed Ice selection that will be dispensed when the push switch is pressed.

2 FREEZER TEMPERATURE

Indicates the set temperature of the freezer compartment in Celsius or Fahrenheit.

3 REFRIGERATOR TEMPERATURE

Indicates the set temperature of the refrigerator compartment in Celsius or Fahrenheit.

4 EXPRESS FRZ.

When the EXPRESS FRZ. button is pressed, the display will indicate the selected function has been activated.

5 DISPENSER LIGHT INDICATOR

When the LIGHT button is pressed, the display will indicate the selected function: The dispenser light is on, this indicator will appear on the display panel.

6 DOOR ALARM INDICATOR

This indicator shows that the door-open warning alarm is activated.

7 WATER FILTER STATUS

This indicator shows the current status for the water filter. See Resetting the Filter Indicator.

8 LOCK STATUS

This indicator shows the current status for the control panel functions is set to LOCK.

NOTE

- Your model may not include every option.

Adjusting The Temperatures And Display

Adjust Freezer Temperature

To adjust the temperature in the freezer compartment, press the FREEZER button to cycle through the the range of available settings.



Adjust Refrigerator Temperature

To adjust the temperature in the refrigerator compartment, press the REFRIGERATOR button to cycle through the range of available settings.



NOTE

- The actual inner temperature varies depending on the food status, since the indicated temperature setting is the target temperature and not the actual temperature within the refrigerator. Initially set the REFRIGERATOR CONTROL at 3 degrees C and the FREEZER CONTROL at -19 degrees C. Leave them at these setting for 24 hours (one day) to stabilize. Then adjust the compartment temperature as illustrated above.

Operating The Dispenser

Dispensing Crushed Ice

Press the ICE TYPE button to illuminate the Crushed Ice icon. Press the push ice switch with a glass or other container and crushed ice will be dispensed.



Dispensing Cubed Ice

Press the ICE TYPE button to illuminate the Cubed Ice icon. Press the push switch with a glass or other container and cubed ice will be dispensed.



NOTE

- Hold the glass or other container in place for a couple of seconds after dispensing ice or water to catch the last few cubes or drops. The dispenser is designed to not operate while either refrigerator door is open.

Controlling The Dispenser Light

Press the LIGHT/FILTER button to turn the dispenser light on and off.

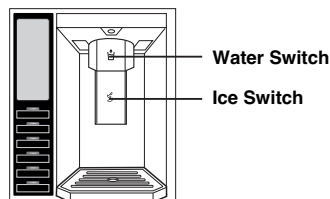

CAUTION

- When filling the container with a small opening, use it near the opening of the water or ice dispenser as close as possible.
- Do not dispense ice into fine china or crystal glasses. China or crystal can break.

Incorrect

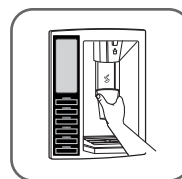

Correct

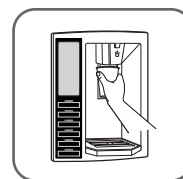

Setting The Functions

Press the button for the desired function to view and select other settings.

Setting The Dispenser Lock



Press and hold the ALARM/LOCK button for three seconds to lock the dispenser and all of the other control panel functions.

Press and hold again for 3 seconds to unlock.

Setting The Door Alarm



The ALARM/LOCK button also controls the door alarm that sounds three times in 30-second intervals when a compartment door is left open for more than 60 seconds. The alarm stops sounding when the door is closed.

Press the ALARM/LOCK button once to activate and deactivate the door alarm function.

NOTE

- Contact your local service center if the alarm continues to sound after the doors are closed.

Resetting The Filter Indicator



Press and hold the LIGHT/FILTER button for more than 3 seconds to reset the filter indicator after the water filter has been replaced.

NOTE

- It is recommended that you replace the filter when the water filter indicator light reaches 0 or whenever the water or ice cube taste deteriorates noticeably.

Activating EXPRESS FREEZING



Press the EXPRESS FRZ. button once to activate the EXPRESS FREEZING function. The EXPRESS FRZ. icon on the display panel will illuminate when activated. The EXPRESS FREEZING function runs the freezer compartment at the coldest setting for a 24-hour period to increase icemaking by up to about 20%, and then turns off automatically.

NOTE

- Press the button again to cancel the EXPRESS FREEZING function.

After dispenser is used

The water collector has no self-drainage function, so it should be cleaned regularly. Remove the cover by pulling the front of the water collector cover and dry it with a cloth.

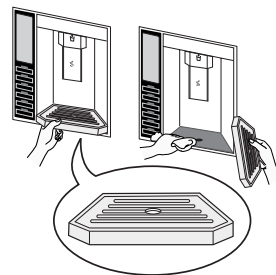

Automatic icemaker

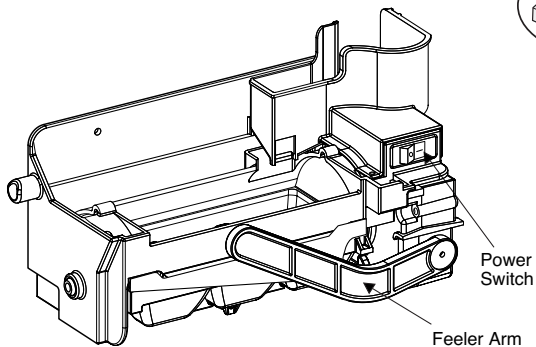

- The automatic icemaker can automatically make 6 cubes at a time, 25~35 pieces per day. This quantity may vary by circumstance, including ambient temperature, door opening, freezer load. etc.
- Icemaking stops when the ice storage bin is full.
- If you don't want to use the automatic icemaker, turn the icemaker switch to OFF. If you want to use automatic icemaker again, change the switch to ON.

NOTE

- It is normal that a noise is produced when ice drops into the ice storage bin.

⚠ WARNING

- Do not insert your hands in to the Icemaker when in operation. It may cause an injury to you.

How to disassemble the automatic icemaker

WARNING

When ice maker does not operate smoothly

The other functions

Hold the ice maker cover with both hands and pull it toward you while pressing the button on part (1).

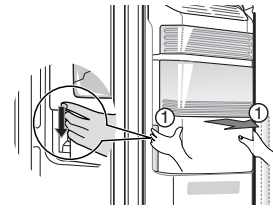

- Do not disassemble the ice maker unless it is necessary.
- Hold the ice storage bin using both hands so that it does not fall.
- Do not touch the ice dispenser with your hand or tool.
- Because the ice maker can operate by opening the freezer door, please take precaution.
- When you want to use the ice bucket space as the storage space, make sure to use it by turning off the ice maker after removing the ice bucket.

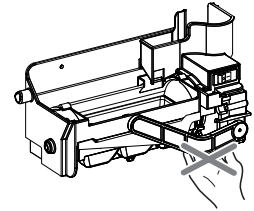

Ice is lumped together

- When ice is lumped together, take the ice lumps out of the ice storage bin, break them into small pieces, and then place them into the ice storage bin again.
 - When the ice maker produces too small or lumped together ice, the amount of water supplied to the ice maker need to adjusted. Contact the service center.
- ※ If ice is not used frequently, it may lump together.

Power failure

- Ice may drop into the freezer compartment. Take the ice storage bin out and discard all the ice then dry it and place it back. After the machine is powered again, crushed ice will be automatically selected.

The unit is newly installed

- It takes about 12 hours for a newly installed refrigerator to make ice in the freezer compartment.

Door open warning

- The alarm will sound three times every 30 seconds if any door (Including Home Bar) is left open or not closed properly for longer than 60 seconds.
- Please contact with the local service center if warning continue to sound even after closing the door.

Diagnosis (failure detection) function

- Diagnosis function automatically detects failure when failure is found in product during the use of refrigerator.
- If a failure occurs in the product, it will not function correctly when any button is selected. The display will not change regardless of what button or option is selected, if this occurs DO NOT switch the unit it off as this will clear any error codes and extend the time needed do diagnose the fault. Contact an approved service center immediately.

How ice/cold water is supplied

Water is cooled while stored in the water tank in the refrigerator compartment, and then sent to the dispenser. Ice is made in the automatic ice maker and sent to the dispenser where it is dispensed as cubed or crushed ice as selected.

NOTE

- It is normal that the water is not very cold at first. If you want colder water, add ice into the glass.

CAUTION**Throw away the ice (about 20 pieces) and water (about 7 glasses) first made after refrigerator installation.**

The first ice and water may include particles or odor from the feed water pipe or feed water box. This is necessary in case that the refrigerator has not been used for a long time.

Keep children away from the dispenser.

Children may play with dispenser and damage switch or lamps.

Be careful that stored items do not fall into and block the ice chute.

Poorly packed items may fall into dispenser and block ice chute and prevent ice dispensing. The ice chute may also become encrusted with ice flakes if crushed ice is selected often, this may lead to the ice chute not opening correctly. If this occurs remove the accumulated ice flakes.

Never store beverage cans or other foods in ice storage bin for the purpose of rapid cooling.

Such actions may damage the automatic ice maker.

Never use thin crystal glass or crockery to collect ice.

Such glasses or containers may be broken.

Put ice first into a glass before filling water or other beverages.

Water may be splashed if ice is added to existing liquid in a glass.

Never place hands or tools near ice outlet.

Touching or adjusting the ice chute can result in injury or product damage.

Never remove the ice maker cover.**Sometimes level the surface so that the ice storage bin is fully filled with ice.**

The ice is dispensed into the same portion of the ice bin all the time, this may result in the ice "piling up" and resulting in the bin being detected as full when it is not completely full. Occasionally if ice is not used often, shift the ice about to level it out allowing the ice maker to continue to make ice and fill bin fully.

If discolored ice is dispensed, immediately contact service center, stopping use.**Never use too narrow or deep glass.**

Ice may be jammed in ice chute and, thus, the refrigerator may fail.

Keep the glass at a proper distance from ice outlet.

A glass too close to the outlet may hinder ice from coming out.

How to use**Shelf**

You can store side dish or refrigerated food on the shelf with sufficient space in between the containers.

**How to disassemble**

1. Hold the front part of the shelf and pull it out until it gets blocked by the hooking part.

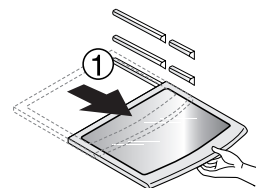

2. When you cannot pull out the shelf any more, lift it up slightly.

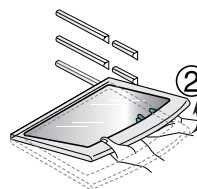

3. While holding the shelf slightly, tilt the shelf to pull it out.

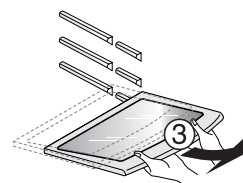
**Egg box**

You can move the egg box to wherever you want.

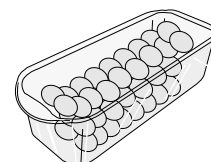
**NOTE**

- Never use the egg box as an ice storage bin. It can be broken.
- Never store the egg box in the freezer compartment or fresh compartment.

Nano charcoal deodorizer**How to use**

With the Nano charcoal deodorizer system, you can deodorize the refrigerator and the deodorizer can be reused.

How to disassemble

Use the (-) driver on the bottom grooved part of the deodorizer cover to separate it while pushing to the front side.

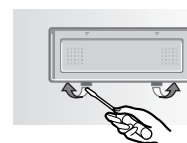
**► How to reuse the deodorizer**

You can reuse the deodorizer continuously by drying it well with the hair dryer.

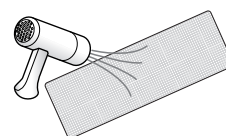

Fresh compartment

How to use

You can store fruits or vegetables.

How to disassemble the upper fresh compartment

1. Hold the front handle of the fresh compartment and pull it out until it gets blocked by the hooking part.
 2. When you cannot pull out the fresh compartment any more, lift it up slightly to pull it out completely to the front side (outer side).
- * The fresh compartment can be reassembled in the reverse order.

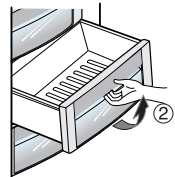
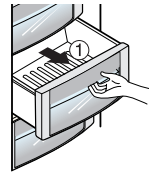

How to disassemble the lower fresh compartment

► When pulling out the lower fresh compartment

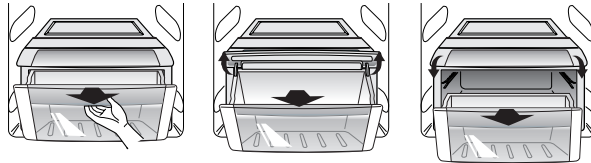

1. Hold the front handle of the fresh compartment and pull it forward.
2. When you cannot pull out the fresh compartment any more, lift it up slightly to pull it out to the front side.

► When inserting the lower fresh compartment



- * When inserting the fresh compartment, always lift the cover up to push it in.

WARNING

- Always disassemble the fresh compartment using two hands. You can be injured from the weight of the compartment when filled with food.
- When disassembling/reassembling the fresh compartment of the fridge, open the refrigerator door fully.

How to disassemble upper/lower fresh compartment cover

Hold the cover with both hands and pull it out.

- * When disassembling the cover, always disassemble the fresh compartment first.

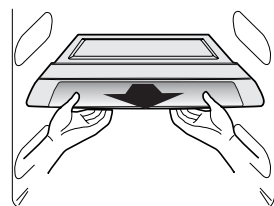

Vacuum fresh compartment

How to use

You can store vegetables or fruits freshly for a long period of time.

- In the middle vacuum fresh compartment, you can store the vegetable or fruit for a longer period of time with the improved seal and vacuum effect.

How to disassemble the vacuum fresh compartment

1. Hold the front handle of the vacuum fresh compartment and pull it out until it gets blocked by the hooking part.
2. When you cannot pull out the vacuum fresh compartment any more, lift it up slightly to pull it out completely to the front side (outer side).

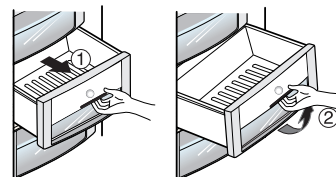

NOTE

- You can disassemble/reassemble the freezer drawer in the same method.
- Always disassemble the fresh compartment using two hands. (You can be injured from the weight of the compartment when filled with food.)
- When disassembling/reassembling the fresh compartment or vacuum fresh compartment of the fridge, open the refrigerator door fully.

How to disassemble the vacuum fresh compartment

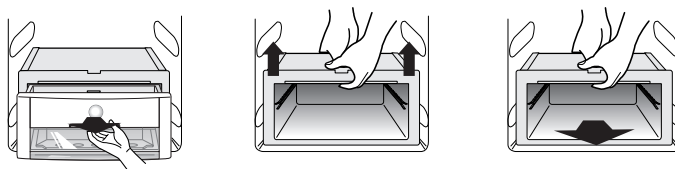

1. Pull the vacuum fresh compartment to the front and slightly lift it up to pull it out.
2. Hold the vacuum fresh compartment with both hands and slightly lift it up.
 - * To disassemble the case, you must first disassemble the upper fresh compartment.
3. Pull it out to the front.

How to reassemble the Vacuum fresh compartment

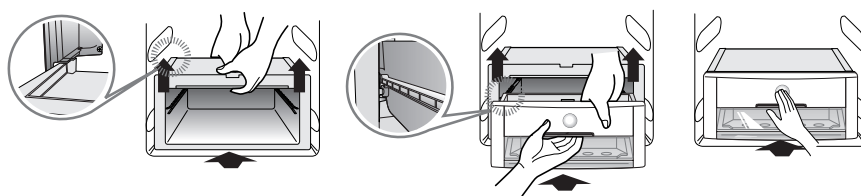

1. Align the top of the case to the side rails and push while slightly holding it up.
2. Align the bottom of the case on top of the rails and push while slightly holding it up.
3. Push the case until you hear the "Click" sound.

WARNING

- Always disassemble the fresh compartment using two hands. You can be injured from the weight of the compartment when filled with food.
- When disassembling/reassembling the fresh compartment of the fridge, open the refrigerator door fully.

Freezer/Fridge basket

How to use

You can store small packaged frozen food (Freezer basket), small packaged refrigerated food or beverages (Fridge basket) such as milk, beer etc.

But, do not store ice cream or food to store for a long period of time (Freezer basket) etc.

How to disassemble

Hold the basket with both hands and slightly lift up the front part to pull it out.

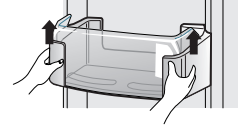

How to reassemble

Hold the basket with both hands and reassemble one side at a time by pushing it in.

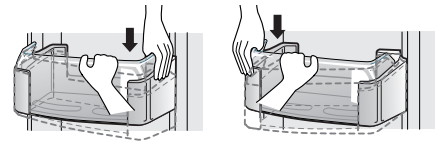

Dairy corner

How to use

You can store dairy goods such as butter, cheese etc.

How to disassemble

Hold the basket with both hands and pull it out by pulling it up(1).

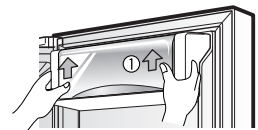

- ▶ If you close the refrigerator door with the dairy corner left open on the door side, the refrigerator door may not be closed properly. Therefore you must be careful.

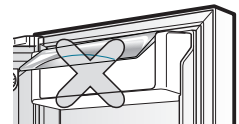

How to exchange the water purifier filter

Because the filter is assembled on the top right side of the refrigerator lamp case and it removes the residual chlorine or odor, exchange a filter once every 6 months.

How to disassemble the filter

How to exchange

1. Disassemble the water purifier filter.

- Turn the filter to exchange in counterclockwise direction by 90 degrees. (1) Pull out the filter to the front side (2).

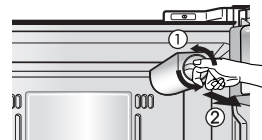

- Because water collected in the filter may drip, put a bowl slightly larger than the size of the filter underneath the filter when disassembling the filter.

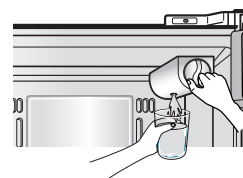

2. Insert the new filter.

- Align the filter on the indicated line on the control box (1) and then push it in.

After checking whether the indicated line and the indicated locking line are aligned, turn the filter in clockwise direction (2).

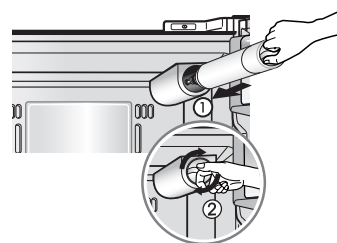

- When you have install the filter for the first time or when you have exchanged the filter, press the dispenser button once again to dispense the water for about 3 minutes (or about 1 liter) to remove any air or residual charcoal. (Charcoal is not hazardous to the human body.)

When LED lamp doesn't light up

Is LED lamp turned on?

- As LED lamp is difficult for customer to exchange directly, please contact to LG Electronics service center unless the lamp light up.

Location of foods

(Refer to identification of parts)

Freezer compartment shelf

Store various frozen foods such as meat, fish, ice cream, frozen snacks, etc..

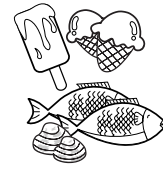

Freezer compartment door rack

- Store small packed frozen food.
- Temperature is likely to increase as door opens. So, do not store long-term food such ice cream, etc..

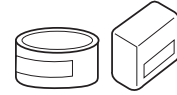

Freezer compartment drawer

- Store meat, fish, chicken, etc.. after wrapping them with thin foil.
- Store dry.

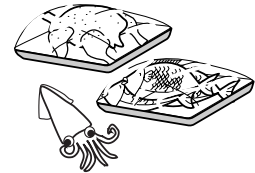

Dairy corner

Store milk products such as butter, cheese, etc..



Egg box

Place this egg box in the proper location.



Refreshment center

Store foods of frequent use such as beverage, etc..



Refrigerator compartment shelf

Store side dishes or other foods at a proper distance.

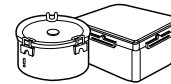

Refrigerator compartment door rack

Store small packed food or beverages such as milk, juice, beer, etc..



Vegetable drawer

Store vegetables or fruits.

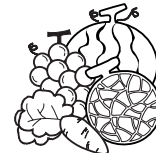

Vegetable drawer /meat drawer conversion corner

Store vegetable, fruits, meat to thaw, raw fish, etc.. setting the conversion switch as necessary.



Be sure to check the conversion switch setting before storing foods.



Storing foods

- Store fresh food in the refrigerator compartment. How food is frozen and thawed is an important factor in maintaining its freshness and flavor.
- Do not store food which goes bad easily at low temperatures, such as bananas, and melons.
- Allow hot food to cool prior to storing, placing hot food in the refrigerator could spoil other food, and lead to higher energy consumption.
- When storing the food, cover it with vinyl wrap or store in a container with a lid. This prevents moisture from evaporating, and helps food to keep its taste and nutrients.
- Do not block air vents with food. Smooth circulation of chilled air keeps refrigerator temperatures even.
- Do not open the door frequently. Opening the door lets warm air enter the refrigerator, and cause temperatures to rise.
- Never keep too much food in door rack because they may push against by inner racks so that the door cannot be fully closed.

Freezer compartment

- Do not store bottles in the freezer compartment - they may break when frozen.
- Do not refreeze food that has been thawed. This causes loss of taste and nutrient.
- When storing frozen food like ice cream for a long period, place it on the freezer shelf, not in the door rack.
- Do not touch the cold foods or containers- especially made of metallic -, with wet hands or place liquid filled glass products in the freezer compartment.
- You may receive frost bite. Glass containers may break when the internal liquids freeze causing personal injury.

Refrigerator compartment

- Always clean food prior to refrigeration. Vegetables and fruits should be washed and wiped, and packed food should be wiped, to prevent adjacent food from spoiling.
- When storing eggs in their storage rack or box, ensure that they are fresh, and always store them in an upright position, which keeps them fresh longer.

NOTE

- If you keep the refrigerator in a hot and humid place, frequent opening of the door or storing a lot of vegetables in it may cause dew to form which has no effect on its performance. Remove the dew with a lint free cloth.

General information

Vacation time

During average length vacations, you will probably find it best to leave the refrigerator in operation. Place freezable items in freezer for longer life. When you plan not to operate, remove all food, disconnect the power cord, clean the interior thoroughly, and leave each door OPEN to prevent odor formation.

Power failure

Most power failures that are corrected in an hour or two will not affect your refrigerator temperatures. However, you should minimize the number of door openings while the power is off.

If you move

Remove or securely fasten down all loose items inside the refrigerator. To avoid damaging the height adjusting screws, turn them all the way into the base.

Anti condensation pipe

The outside wall of the refrigerator cabinet may sometimes get warm, especially just after installation. Don't be alarmed. This is due to the anti-condensation pipe, which pumps hot refrigerator to prevent "sweating" on the outer cabinet wall.

CAUTION

- You must check the O-RING, which is made by rubber and prevent electric spark.
- Don't touch the lamp, it can get very hot if left on for a long length of time.

Cleaning

It is important that your refrigerator be kept clean to prevent undesirable odors. Spilled food should be wiped up immediately, since it may acidify and stain plastic surfaces if allowed to settle.

Exterior

Use a lukewarm solution of mild soap or detergent to clean the durable finish of your refrigerator. Wipe with a clean damp cloth and then dry.

Interior

Regular cleaning is recommended. Wash all compartments a baking soda solution or a mild detergent and warm water. Rinse and dry.

After cleaning

Please verify that the power cord is not damaged, power plug is not overheated, or power plug is well inserted into the power consent.

WARNING

Always remove power cord from the wall outlet prior to cleaning in the vicinity of electrical parts (lamps, switches, controls, etc.).

Wipe up excess moisture with a sponge or cloth to prevent water or liquid from getting into any electrical part and causing an electric shock.

Never use metallic scouring pads, brushes, coarse abrasive cleaners, strong alkaline solutions, flammable or toxic cleaning liquids on any surface.

Do not touch frozen surfaces with wet or damp hands, because damp object will stick or adhere to extremely cold surfaces.

Trouble shooting

Before calling for service, review this list. It may save you both time and expense. This list includes common occurrences that are not the result of defective workmanship or materials in this appliance.

Occurrence	Possible cause	Solution
Runing of refrigerator		
Refrigerator compressor does not run.	Refrigerator control is off.	Set refrigerator control. See setting the controls.
	Refrigerator is in defrost cycle.	This is normal for a fully automatic defrosting refrigerator. The defrost cycle occurs periodically.
	Plug at wall outlet is disconnected.	Make sure plug is tightly pushed into outlet.
	Power outage. Check house lights.	Call local electric company.
Refrigerator runs too much or too long	Refrigerator is larger than the previous one you owned.	This is normal. Larger, more efficient units run longer in these conditions.
	Room or outside weather is hot.	It is normal for the refrigerator to work longer under these conditions.
	Refrigerator has recently been disconnected for a period of time.	It takes some hours for the refrigerator to cool down completely.
	Large amounts of warm or hot food may have been stored recently.	Warm food will cause the refrigerator to run longer until the desired temperature is reached.
	Doors are opened too frequently or too long.	Warm air entering the refrigerator causes it to run longer. Open the door less often.
	Refrigerator or freezer door may be slightly open.	Make sure the refrigerator is level. Keep food and containers from blocking door. See problem section. OPENING/CLOSING of doors.
	Refrigerator control is set too cold.	Set the refrigerator control to a warmer setting until the refrigerator temperature is satisfactory.
	Refrigerator or freezer gasket is dirty, worn, cracked, or poorly fitted.	Clean or change gasket. Leaks in the door seal will cause refrigerator to run longer in order to maintain desired temperatures.
	Thermostat is keeping the refrigerator at a constant temperature.	This is normal. Refrigerator goes on and off to keep the temperature constant.

Occurrence	Possible cause	Solution
Refrigerator compressor does not run.	Thermostat is keeping the refrigerator at a constant temperature.	This is normal. The refrigerator goes on and off to keep the temperature constant.
Temperatures are too cold		
Temperature in the freezer is too cold but the refrigerator temperature is satisfactory.	Freezer control is set too cold	Set the freezer control to a warmer setting until the freezer temperature is satisfactory.
Temperature in the refrigerator is too cold and the freezer temperature is satisfactory.	Refrigerator control is set too cold.	Set the refrigerator control to a warmer setting
Food stored in drawers freezes.	Refrigerator control is set too cold.	See above solution.
Meat stored in fresh meat drawer freezes.	Meat should be stored at a temperature just below the freezing point of water (32°F, 0°C) for maximum fresh storage time.	It is normal for ice crystals to form due to the moisture content of meat.
Temperatures are too warm		
Temperatures in the refrigerator or freezer are too warm.	Freezer control is set too warm.	Set the freezer or refrigerator control to a colder setting until the freezer or refrigerator temperature is satisfactory.
	Refrigerator control is set too warm. Refrigerator control has some effect on freezer temperature.	Set the freezer or refrigerator control to a colder setting until the freezer or refrigerator temperature is satisfactory.
	Doors are opened too frequently or too long.	Warm air enters the refrigerator/ freezer whenever the door is opened. Open the door less often.
	Door is slightly open.	Close the door completely.
	Large amounts of warm or hot food may have been stored recently.	Wait until the refrigerator or freezer has a chance to reach its selected temperature.
	Refrigerator has recently been disconnected for a period of time.	A refrigerator requires some hours to cool down completely.
Temperature in the refrigerator is too warm but the freezer temperature is satisfactory.	Refrigerator control is set too warm.	Set the refrigerator control to a colder setting.

Occurrence	Possible cause	Solution
Sound and noise		
Louder sound levels when refrigerator is on.	Today's refrigerators have increased storage capacity and maintain more even temperatures.	It is normal for sound levels to be higher.
Louder sound levels when compressor comes on.	Refrigerator operates at higher pressures during the start of the ON cycle.	This is normal. The sound will level off as the refrigerator continues to run.
Vibrating or rattling noise.	Floor is uneven or weak. Refrigerator rocks on the floor when it is moved slightly.	Be sure floor is level and solid and can adequately support refrigerator.
	Items placed on the top of the refrigerator are vibrating.	Remove items.
	Dishes are vibrating on the shelves in the refrigerator.	It is normal for dishes to vibrate slightly. Move dishes slightly. Make sure refrigerator is level and firmly set on floor.
	Refrigerator is touching wall or cabinets.	Move refrigerator so that it does not touch the wall or refrigerator.
Water/Moisture /Ice inside refrigerator		
Moisture collects on the inside walls of the refrigerator.	The weather is hot and humid which increases the rate of frost buildup and internal sweating.	This is normal.
	Door is slightly open.	See problem section opening/closing of doors.
	Door is opened too often or too long.	Open the door less often.
Water/Moisture /Ice outside refrigerator		
Moisture forms on the outside of the refrigerator or between doors.	Weather is humid.	This is normal in humid weather. When humidity is lower, the moisture should disappear.
	Door is slightly open, causing cold air from the inside the refrigerator to meet warm air from the outside.	This time, close the door completely.

Occurrence	Possible cause	Solution
Odors in refrigerator		
	Interior needs to be cleaned.	Clean interior with sponge,warm water and baking soda.
	Food with strong odor is in the refrigerator.	Cover food completely.
	Some containers and wrapping materials produce odors.	Use a different container or brand of wrapping materials.
Opening/Closing of doors/Drawers		
Door(s) will not close.	Food package is keeping door open.	Move packages that keep door from closing.
Door(s) will not close.	Door was closed too hard, causing other door to open slightly.	Close both doors gently.
	Refrigerator is not level. It rocks on the floor when it is moved slightly.	Adjust the height adjusting screw.
	Floor is uneven or weak. Refrigerator rocks on the floor when it is moved slightly.	Be sure floor is level and can adequately support refrigerator. Contact carpenter to correct sagging or sloping floor.
	Refrigerator is touching wall or cabinets.	Move refrigerator..
Drawers are difficult to move.	Food is touching shelf on top of the drawer	Keep less food in drawer.
	Track that drawer slides on is dirty.	Clean drawer and track.
Dispenser		
Dispenser will not dispense ice	Ice storage bin is empty.	When the first supply of ice is dropped into the bin, the dispenser should operate.
	Freezer temperature is set too warm.	Turn the freezer control to a higher setting so that ice cubes will be made. When the first supply of ice is made, the dispenser should operate.
	Household water line valve is not open.	Open household water line valve and allow sufficient time for ice to be made. When ice is made, dispenser should operate.
	Refrigerator or freezer door is not closed.	Be sure both doors are closed.

Occurrence	Possible cause	Solution
Dispenser will not dispense ice.	Ice has melted and frozen around auger due to infrequent use, temperature fluctuations and/or power outages.	Remove ice storage bin, and thaw and the contents. Clean bin, wipe dry and replace in proper position. When new ice is made, dispenser should operate.
Ice dispenser is jammed.	Ice cubes are jammed between the ice maker arm and back of the bin.	Remove the ice cubes that are jamming the dispenser.
	Ice cubes are frozen together.	Use the dispenser often so that cubes do not freeze together.
	Ice cubes that have been purchased or made in some other way have been used in the dispenser.	Only the ice cubes made by the ice maker should be used with the dispenser.
Dispenser will not dispense water.	Household water line valve is not open. See problem "Ice maker is not making any ice."	Open household water line valve.
	Refrigerator or freezer door is not closed.	Be sure both doors are closed.
Water has an odd taste and/or odor.	Water has been in the tank for too long.	Draw and discard 7 glasses of water to freshen the supply. Draw and discard an additional 7 glasses to completely rinse out tank.
	Unit not properly connected to cold water line.	Connect unit to cold water line which supplies water to kitchen faucet.
Sound of ice dropping	This sound is normally made when automatically made ice is dropped into ice storage bin. Volume may vary according to refrigerator's location.	
Sound of water supply	This sound is normally made when ice maker is supplied with water after dropping the automatically made ice.	
Other	Please thoroughly read 'Automatic ice maker and dispenser' in this manual.	

It is Normal...

The following occurrences are normal.

	Occurrence	Solution
Noise	When you hear "Tak" or "Took" sound	This is the sound of various parts expanding/contracting or various control devices operating depending on the temperature change within the refrigerator.
	When you hear "Deureureuk~", "Dulkuk" or "Woong" sound	This is the count of compressor or fan operating when the operation of the refrigerator is starting or ending. This is the same phenomenon of the sound generated when starting or turning off the engine of a car.
	When you hear "Kureureuk" sound of water flowing	This is the sound of refrigerant changing the condition in the freezer/fridge. When the liquid changes to gas, you will hear the sound of water flowing and when gas changes to liquid, you will hear the "Kureureuk" sound.
	When you hear the sound of wind such as "Shoo~" or "Shik" right after you close the door	This is the sound generated when the internal pressure is temporarily lowered when the warm air entered through the fridge or freezer is cooled fast.
	When you hear the vibrating sound	If the refrigerator is installed on wooden floor or wooden wall, or if the refrigerator is not leveled properly, the sound can be loud from the vibration.
	When you hear a loud sound after installing the product for the first time	When you operate the refrigerator for the first time, the refrigerator will operate at high speed to cool fast and the sound can seem louder. When the internal temperature falls below a certain level, the noise will subside.
Door open	When the door is slightly opened after closing the door	Depending on the force or speed of closing the fridge or freezer door, the door can open slightly and then get closed. Be careful not to close the door too hard.
Icing/ Dew drops	When there is icing or dew drops formed on the inner or outer side of the refrigerator	When external air flows into the cool inner surface of the refrigerator, icing/dew drops can be formed. Especially, this will happen more easily when you open and close the refrigerator door more frequently. Also if the humidity of the installed location is high or during the rainy season or on a rainy day, dew drops can form on the outer side of the refrigerator. This is a natural phenomenon that occurs during the humid weather. Wipe the water drops with a dry cloth.
Temperature	When the front side of the refrigerator is warm	Heat pipes are installed around the front part of the refrigerator and on the divider of the freezer and fridge to prevent the dew drops from forming. The refrigerator may feel warmer after the installation or during the hot summer, but this is not a problem and you can be rest assured.

