

Miele

NAVITRONIC

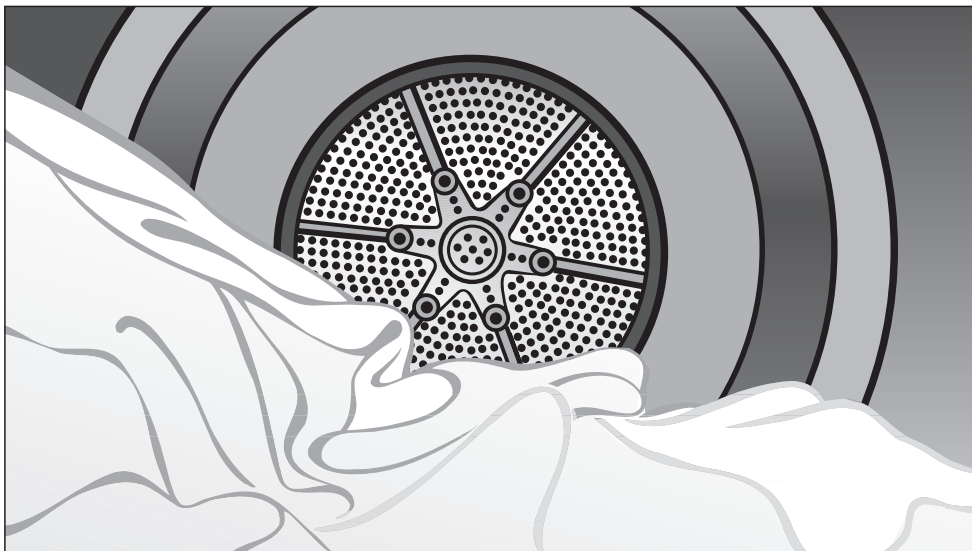

Operating instructions for condenser tumble dryer T 8685 C

To avoid the risk of accidents
or damage to the appliance
it is **essential** to read these
instructions before it is installed
and used for the first time.

en - GB

M.-Nr. 07 606 600

Caring for the environment

Disposal of the packing material

The transport and protective packing has been selected from materials which are environmentally friendly for disposal and can normally be recycled.

Ensure that any plastic wrappings, bags etc. are disposed of safely and kept out of the reach of babies and young children. Danger of suffocation!

Rather than just throwing these materials away, please ensure they are offered for recycling.

Disposal of your old appliance

Electrical and electronic appliances often contain materials which, if handled or disposed of incorrectly, could be potentially hazardous to human health and to the environment. They are, however, essential for the correct functioning of your appliance. Please do not therefore dispose of your appliance with your household waste.

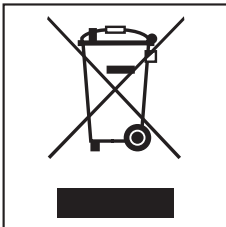

Please dispose of it at your local community waste collection / recycling centre or contact your Dealer for advice. Ensure that it presents no danger to children while being stored for disposal.

Energy saving tips

To avoid unnecessarily long drying times and high consumption of energy:

- Make sure that your laundry is thoroughly spun before drying.

The higher the spin, the greater the savings that can be made in energy and time during drying.

- Load according to the optimum amount of laundry recommended for the programme being used (see Programme chart).

Underloading is uneconomical.



Overloading gives a poorer quality of drying and may cause unnecessary creasing.

- Make sure the room in which the dryer is located is well ventilated.
- Make sure the fluff filters are clean before using the dryer.
- Check the condenser unit from time to time and clean it when necessary.

Caring for the environment	2
Warning and Safety instructions	6
Operating the tumble dryer	10
Control panel	10
Display	11
Before using for the first time	13
Notes on laundry care	14
Care symbols	14
Tips on drying	14
How to dry correctly	15
Brief instructions	15
Favourite programmes	18
Selecting/changing a favourite	18
Saving a favourite programme	20
Extra options	21
Short	21
Low temperature	21
Timer	22
Programme chart	23
Changing the programme sequence	28
Once a programme has started	28
- changing the programme	28
- cancelling the programme and then selecting a different programme	28
- cancelling the programme and then removing the laundry	28
Adding or removing laundry after a programme has started	28
Time remaining	28

Contents

Electronic programme locking	29
Cleaning and care	30
Emptying the condensed water container	30
Cleaning the fluff filters	31
Cleaning them whilst dry	31
Cleaning them with water	32
Cleaning the tumble dryer	33
Cleaning the condenser unit	34
Removing the condenser unit	34
Checking the condenser unit	35
Cleaning the condenser unit	35
Replacing the condenser unit	36
Problem solving guide	37
Problem solving guide	37
Fault messages in the display	37
Other problems	39
Changing the lamp	42
After Sales service	43
Repairs	43
Future updates (PC)	43
Appliance guarantee	43
Optional accessories	43
Installation	44
Front view	44
Rear view	45
Installation site	45
Transporting the machine to its installation site	45
Building under a continuous worktop / in a kitchen run	45
Levelling the machine	46
Room in which the dryer is located	46
Washer-dryer stack	46
Before moving the machine again (e.g. when moving house)	46

External condensed water outlet	47
Arranging the drain hose	47
External drainage via a sink or gully	48
Installation conditions requiring a non-return valve	48
Electrical connection	50
Electrical connection U.K.	50
Consumption data	51
Technical data	52
Settings menu 	54
Language 	54
Time of day	55
Drying levels	56
Extended cool down	56
Airways indicator	57
Anti-crease action	57
Code	57
Buzzer	59
Keypad tones	59
Display contrast	59
Standby	60
Miele@home	61
Remote access	63

Warning and Safety instructions

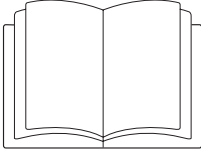

► It is **essential** to read these instructions.

This tumble dryer conforms to current safety requirements. Inappropriate use can, however, lead to personal injury and damage to property.

To avoid the risk of accidents and damage to the tumble dryer, please read these instructions carefully before using it for the first time. They contain important information on its safety, installation, use and maintenance.

Keep these instructions in a safe place and ensure that new users are familiar with the content. Pass them on to any future owner.

Correct application

► This tumble dryer is for domestic use only and can only be used to dry items which have been washed in a water solution and which are marked on the manufacturer's care label as being suitable for tumble drying. "Dry cleaning kits" for freshening up garments in a tumble dryer are increasingly available on the market. If using, do so at your own risk, and follow the instructions provided on the packaging.

Any other applications may be dangerous. Miele cannot be held liable for damage resulting from incorrect or improper use or operation.

► This appliance is not intended for use by persons (including children) with reduced physical, sensory or mental capabilities, or lack of experience or knowledge, unless they are supervised whilst using it or have been shown how to use it by a person responsible for their safety.

Safety with children

► Keep children away from the tumble dryer at all times. It is not a toy! To avoid the risk of injury do not allow them to play on or near it or to play with its controls. Supervise children whilst you are using it.

► Older children may only use it if its operation has been clearly explained to them, and they are able to use it safely, recognising the dangers of incorrect use.

Warning and Safety instructions

Technical safety

► Before setting up the tumble dryer, check it for any externally visible damage.

Do not install or use a damaged tumble dryer.

► Before connecting the tumble dryer, ensure that the connection data on the data plate (voltage and connected load) match the mains electricity supply. If in any doubt, consult a qualified electrician.

► The electrical safety of this tumble dryer can only be guaranteed when continuity is complete between it and an effective earthing system which complies with current local and national safety regulations. It is most important that this basic safety requirement is present and regularly tested, and where there is any doubt the household wiring system should be inspected by a qualified electrician. Miele cannot be held liable for the consequences of an inadequate earthing system (e.g. electric shock).

► Do not connect the tumble dryer to the mains electricity supply by an extension lead. Extension leads do not guarantee the required safety of the tumble dryer (e.g. danger of overheating).

► Unauthorised repairs could result in unforeseen dangers for the user, for which Miele cannot accept liability. Repairs should only be undertaken by a Miele approved service technician. Ensure current is not supplied to the tumble dryer until after maintenance or repair work has been carried out.

► Faulty components must only be replaced by genuine Miele original spare parts. Only when these parts are fitted can the safety standards of the tumble dryer be guaranteed.

► If the connection cable is faulty it must only be replaced by a Miele approved service technician to protect the user from danger.

► In the event of a fault or for cleaning purposes, the tumble dryer is only completely isolated from the electricity supply when:

- it is switched off at the wall socket and the plug is withdrawn, or
- it is switched off at the mains, or
- the mains fuse is disconnected, or
- the screw-out fuse is removed (in countries where this is applicable).

► This tumble dryer may only be used in mobile installations such as ships if a risk assessment of the installation has been carried out by a suitably qualified engineer.

► In countries where there are areas which may be subject to infestation by cockroaches or other vermin, pay particular attention to keeping the tumble dryer and its surroundings in a clean condition at all times. Any damage which may be caused by cockroaches or other vermin will not be covered by the guarantee.

► Do not make any alterations to the tumble dryer, unless authorised to do so by Miele.

Warning and Safety instructions

Correct use

▶ To prevent the risk of fire, the following textiles must not be dried in this tumble dryer:

- items which have not been washed.
- items, such as workwear, which have not been thoroughly cleaned and which are still soiled with grease, oil or other deposits (such as cosmetics, lotions etc).
If items have not been thoroughly cleaned there is a danger that these might ignite when heated, even after they have been removed from the dryer at the end of the programme.
- items (e.g. mops and floorheads) which have been treated with inflammable cleaning agents or contain residues of acetone, alcohol, benzene, petrol, stain remover, turpentine, wax, wax remover or other chemicals.
- items which have been splashed with hair lacquer, hair spray, nail varnish remover or similar substances.

When washing such heavily soiled items ensure that you use sufficient detergent and select a high temperature. If in doubt, wash the items several times.

▶ To prevent the risk of fire, the following must not be dried in this tumble dryer:

- items which have been cleaned using chemicals (e.g. professional dry-cleaning agents).
- fabrics which contain a large proportion of rubber, foam rubber or rubber-like materials. For example, products made from latex foam rubber, shower caps, waterproof textiles, rubberised articles and items of clothing and pillows with foam rubber filling.
- damaged items which contain padding or fillings (e.g. pillows, jackets). When damaged, the filling can get out with the risk of igniting in the dryer.

▶ In many programmes, the heating phase is followed by a cooling down phase to ensure that the items are not too hot to handle when you remove them (this also avoids the danger of the laundry self-igniting). The programme is not finished until the cooling down phase has been completed. Ensure that you always wait until the end of the programme before removing the laundry.

▶ **Warning:** Do not switch the tumble dryer off before the end of the drying programme. If this was done and the laundry was then removed immediately it could give off a great amount of heat.

▶ Fabric conditioner and similar products must be used according to the instructions on the manufacturer's packaging.

Warning and Safety instructions

▶ The dryer must not be used without the fluff filters in place or if the fluff filters are damaged in any way.

▶ The fluff filters must be cleaned regularly.

▶ The dryer must not be used without the condenser unit in place.

▶ The fluff filters must be thoroughly dried after cleaning. Damp or wet filters could cause operational faults.

▶ Do not install the tumble dryer in a room where there is a risk of frost occurring. At temperatures around freezing point the tumble dryer may not be able to operate properly. There is a risk of damage if the condensed water is allowed to freeze in the pump, hoses and / or condensed water container.

The ambient room temperature should be between +2°C and +35°C.

▶ If the water is drained externally through the drain hose instead of being collected in the condensed water container, make sure the drain hose is securely attached if you hang it in a sink or basin to avoid the hose slipping and the water causing damage.

▶ Condensed water is not drinking water.

It can cause health problems in both people and animals.

▶ Always keep the area around the tumble dryer free of dust and fluff. Dust drawn into the tumble dryer can cause blockages in the condenser unit over time.

▶ Do not let anyone sit or lean on the door, as this can cause the tumble dryer to tip up.

▶ Always close the door after use. This way you will avoid the danger of:

- children climbing onto or into the dryer or hiding things in it.
- pets or other small animals climbing into it.

▶ The tumble dryer must not be hosed down.

Accessories

▶ Only use genuine Miele spare parts and accessories with this appliance. If non-Miele parts are used, guarantee, performance and product liability claims may be invalidated.

Miele cannot be held liable for damage caused by non-compliance with these Warning and Safety instructions.

Operating the tumble dryer

Control panel

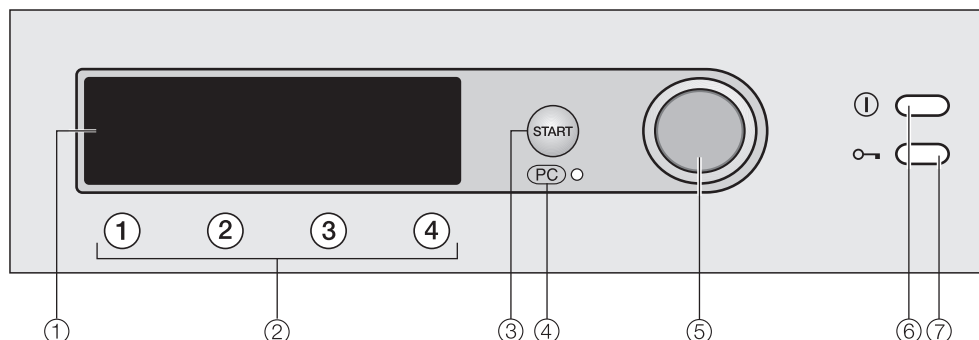

① Display

See the following pages for more information.

② Short cut buttons

For selecting an individual programme quickly. These buttons can be programmed to select your own favourite drying programmes.

③ Start button

④ PC / Optical interface

This is used by service technicians to run diagnostic checks on your machine and can also be used to update programming data in the future.

⑤ Multi-function selector

This is used to select menu options (by turning it) and to confirm your selection (by pressing it).

⑥ On/Off button ①

For switching the dryer on and off. To save energy the dryer will switch off automatically 15 minutes after the end of the programme/anti-crease phase or 15 minutes after the dryer is switched on if it is not operated.

⑦ Door button

Pressing this button will open the door even when the machine is switched off at the mains.

Display

Entry menu

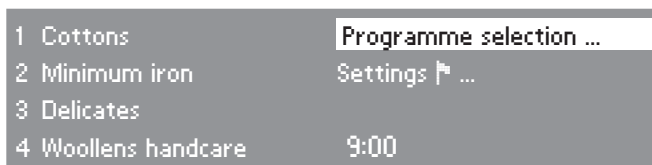

When the machine is switched on, the entry menu (with factory default settings) appears and *Programme selection...* is highlighted.

Multi-function selector

Turning the multi-function selector moves the highlighting to the next option.

Pressing the multi-function selector selects the highlighted option.

Short cut buttons

Pressing a short cut button selects one of the four favourite programmes shown on the left of the display. You can customise the favourite programmes to suit your own requirements.

The short cut buttons have different functions in the other menus. Where this is the case, an arrow ▼ will appear in the display above the short cut button, together with a description of its function .

Programme selection

There are two ways of selecting a programme:

- Option 1: Select the *Programme selection* menu which is highlighted in the display by pressing the multi-function selector.
- Option 2: Press short cut button ①, ②, ③ or ④. This will automatically take you into the main menu of that programme.

Operating the tumble dryer

Programme selection menu

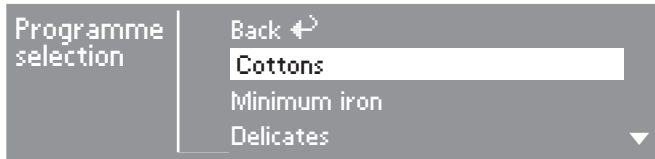

You can use the multi-function selector to select any of the programmes listed. The highlighting will move up or down depending on the direction the multi-function selector is turned in. The ▲ ▼ arrows on the right of the display indicate the direction and further options. Pressing the multi-function selector takes you to the main menu of the programme selected.

Drying programme main menu



- Turn the multi-function selector to highlight either the "Drying level" or the "Programme".
- Pressing the multi-function selector selects the highlighted option and opens the relevant sub-menu.
- The sub-menus *Extras*, *Timer* and *Save* can be opened by pressing the short cut button directly below them. You return to the entry menu by pressing short cut button ④ below the word *Back*.

Alternatively, you can also highlight and confirm all options by just using the multi-function selector.

Important

All the display illustrations and times given in these instructions are examples, and can vary.

Settings menu

The Settings menu is used to alter the tumble dryer's electronics to suit different requirements. See "Settings menu" for more details.

Before using for the first time

When the tumble dryer is switched on for the first time, the welcome screen will appear.

The welcome screen will appear in the display every time you switch the machine on until you have run a programme lasting longer than 1 hour.

The display for setting the language will then appear.

Setting the language

You need to select the language you require for the display.

You can select a different language from the one shown.

It is possible to change the language at any time via the *Settings* menu.

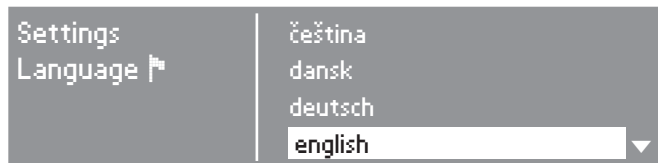

- Use the multi-function selector to select the language you want and confirm your selection. The display will now appear in the language you have selected.

The display for setting the time of day will then appear.

Setting the time of day

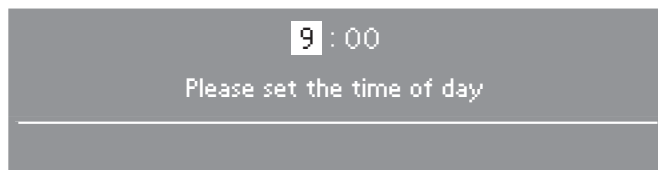

- Turn the multi-function selector to select the hour and press it to confirm your selection. Now set the minutes. Once this has been confirmed, the time of day is saved in memory, and the display goes back to the entry menu.

Notes on laundry care

Care symbols

Before drying check the drying symbol on the care label. If there are no symbols, dry at your own risk!

- ☉ Dry at normal temperature
- ☺ Dry at low temperature
- ☒ Do not tumble dry

Tips on drying

- Always observe the maximum recommended loads given in the "Programme chart". Never overload the drum.

Overloading can cause unnecessary wear and tear to the laundry, give a disappointing drying result and cause more creasing.

- Do not put soaking wet items into the tumble dryer. Spin them thoroughly after washing using the appropriate spin speed.
- For delicates and fabrics with the following care label ☺ select *Low temperature*.
- Use the *Automatic* programme for drying mixed loads of cottons and minimum iron fabrics.
- Open jackets so that they can dry evenly.
- Woollens and wool blends tend to become matted and shrink if dried in a tumble dryer. They can, however, be partially dried using the *Woollens handcare* programme.

- Down-filled garments have linings which have a tendency to shrink, depending on the quality of the item. They can be partially dried using the *Smoothing* programme.
- Pure linen should only be machine dried if specified as suitable by the manufacturer on the care label, as the surface of the fabric may otherwise become rough. They can be partially dried using the *Smoothing* programme.
- Loopknit garments (e.g. T-shirts and underwear) tend to shrink depending on their quality. Do not over-dry these textiles. Be particularly careful when using the *Hygiene* programmes. When purchasing these garments it is advisable to take their shrinkage properties into account.
- For garments made from very fine weave fibres, such as shirts or blouses, use the *Shirts* programme to avoid creasing. If in doubt, reduce the load or use the *Smoothing* programme.
- Starched laundry can be dried in the tumble dryer. To achieve the usual finish, double the amount of starch should be used.
- New dark coloured garments should be washed and dried separately from light coloured garments to avoid the danger of colours running and discolouring other garments or even plastic components in the machine. Dark coloured fibres can also settle on light coloured garments and vice versa.

Brief instructions

The headings numbered (1, 2, 3 ...) show the operating sequence and can be used as a brief guide to using your machine.

1 Sort the laundry

To ensure an even drying result, separate out the washed laundry and sort it according to:

- ... the drying level required
- ... the type of fibre or weave
- ... size
- ... the moisture content after spinning.

 Make sure that objects e.g. detergent dispensing balls have been removed from the laundry. They could melt, and cause damage to the dryer or the laundry.

- Check seams and stitching to ensure that padding and linings are intact.
- Fasten duvet covers and pillow cases to prevent small items from being trapped inside them.
- Fasten hooks and eyes etc.
- Tie fabric belts and apron strings.
- Sew in or remove underwiring from bras.

2 Turn on the tumble dryer

- Switch the dryer on by pressing the On/Off button .

The tumble dryer may be switched on after loading, saving energy as the light will not come on.

3 Load the tumble dryer

- Press the  button to open the door.
- Load the laundry loosely into the drum.

Do not overload the drum. See the "Programme chart" for recommended loads for each programme. Overloading can cause unnecessary wear and tear to the laundry and give a disappointing drying result.

- Before closing the door make sure the fluff filter is correctly positioned in the door.

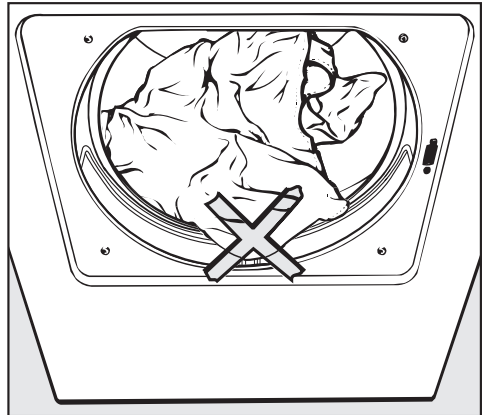

Check the laundry is right inside the drum so that it cannot get trapped or damaged when the door is shut.

- Shut the door either with a gentle swing, or lean against it and push it shut.

How to dry correctly

4 Select a programme

- You can select a programme either by:
 - using the appropriate short cut button to select one of the four programmes listed in the display ('favourites'), or
 - by going into the *Programme selection* menu.
- If required, you can then select any *Extras* and use the *Timer* from the relevant sub-menu.

5 Start the programme

The *Start* button will flash when a programme is being selected. The flashing indicates that a programme can be started.

- Press the *Start* button.

The *Start* button will now light up constantly.

Programme running will appear in the display, followed by *Drying* and the programme duration.

With programmes with drying levels, e.g. *Machine iron*, *Hand iron* etc. the drying level reached will be shown in the display later on.

Important: Please note for programmes with drying levels that the programme duration shown in the display will vary according to the programme selected (see "Programme duration / Estimated time remaining").

Once drying is in progress, you can press short cut:

- **Button 2** *Timer* to call up the current time of day and the estimated end time of the programme.
- **Button 3** *Save* to save the current programme as a favourite.
- **Button 4** *Cancel* to cancel the current programme.

Programme duration / Estimated time remaining

When a programme is selected the estimated drying time will appear in the display. Please be aware that it is only an estimate!

The following factors all affect the estimated time remaining: residual moisture content after spinning; type of fabric; size of load; room temperature; fluctuations in power supply.

The electronics continually assess conditions in the machine and adjust the estimated time remaining for a more accurate reading. Because of this, the time displayed can alter during the course of a programme.

In the same way, the Woollens handcare, Silks handcare and Smoothing programmes can finish earlier than expected if a certain temperature is reached. This can happen with particularly fine fabrics, very small loads or if items were partly dry beforehand.

Before the end of a programme

There is a cooling down phase at the end of the drying sequence: *Cooling down* will appear in the display. The programme will not finish until the cooling down phase has been completed.

There is no cooling down phase at the end of the Woollens handcare, Silks handcare and Smoothing programmes.

6 Remove the laundry when the programme has finished

Anti-crease and *Finish* will appear in the display to indicate that the programme has finished. The buzzer will sound.

During the Anti-crease phase (factory default setting) the drum will continue to rotate at intervals to prevent laundry creasing, if you do not wish to remove it immediately. The anti-crease phase lasts for 1 hour.

- Press the  button to open the door.
- Remove the laundry.

Check that all items have been removed from the drum. If items are left in the dryer, they could be damaged by overdrying when the dryer is next used.

If the dryer is switched on at the mains and the door is opened, the drum lighting will come on. It will go out a few minutes later to save energy.

The dryer will switch off automatically 15 minutes after the end of a programme/the end of the anti-crease phase.

- Press the  button to switch the dryer off.
- Clean the fluff filters.
- Close the door.
- Empty the condensed water container (unless the dryer has been connected for external drainage).

Favourite programmes

You can programme the short cut buttons to call up the four drying programmes you use most frequently.

Selecting/changing a favourite

- Switch the dryer on.

Entry menu



- Press short cut button .

Main menu



- Turn the multi-function selector to highlight either the "Programme" or the "Drying level".
- Confirm your selection of the part you want to change by pressing the multi-function selector once.

Depending on the option highlighted, the following will be displayed:

– Programme selection

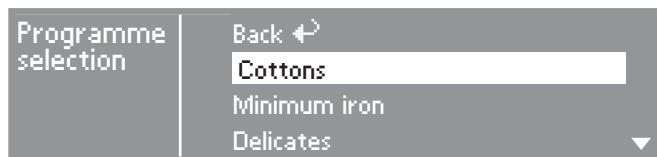

- Use the multi-function selector to select the programme you want and confirm your selection. The main menu will appear.

Favourite programmes

Important: If you do not make a selection in the sub-menu within approx. 15 seconds, the display will revert to the main menu.

– Programmes with drying levels

(*Cottons, Minimum iron, Delicates, Automatic, Shirts, Denim, Sportswear and Outerwear*)



- Use the multi-function selector to select the drying level you want, and confirm your selection.
- Any of the drying levels can be selected for the *Cottons* programme. A more limited range is available when using other programmes.

– Warm air, Cool air and Timed drying hygiene programmes

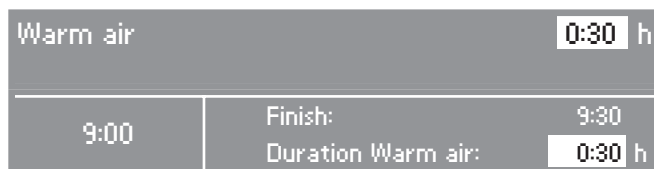

- Use the multi-function selector to select the duration you want and confirm your selection. The end time of the programme (Finish) will alter accordingly.
- A duration of 15 minutes to 2 hours can be selected for the *Warm air* and *Cool air* programmes
- A duration of 1 to 2 hours can be selected for the *Timed drying hygiene* programme

– Other programmes

Woollens handcare, Silks handcare, Smoothing, Pillows, Proofing, Cottons hygiene, Minimum iron hygiene

- The drying levels and duration for these programmes are fixed.

Favourite programmes

Selecting an extra option

- Press short cut button  *Extras*.

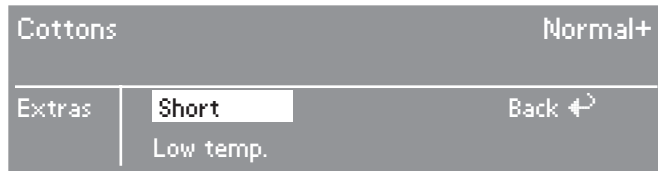

- Use the multi-function selector to select the extra option you want, and confirm your selection. The main menu will reappear.

Saving a favourite programme

All the settings you have selected are now shown in the main menu.



- Press short cut button  *Save*.

Selecting a short cut button



- Use the multi-function selector to select the number you want to save the programme to, and confirm your selection. Your settings have now been saved and the favourite programme and will appear in the Entry menu.

Repeat the procedure if you want to customise other favourite programmes, and save them to short cut buttons which have not yet been used.

Selecting an extra option

Not all the extra options are suitable for use with every programme.

It is not possible to select the *Short* and *Low temperature* options at the same time.

- Use the multi-function selector to select the *Extra* you want, and confirm your selection.

An extra option which has already been selected

- is indicated by a tick ✓.
- can be de-selected by highlighting it and then confirming your selection.

Short

For drying fabrics which can withstand higher temperatures. Do not use on minimum iron or delicate fabrics.

- The programme duration is shorter.

Low temperature

Delicate fabrics are dried at a lower temperature.

- For all delicate or minimum iron fabrics with the  symbol on the care label (e.g. acrylic garments).
- The programme duration is longer.
- On some programmes *Low temperature* is a standard part of the programme and so cannot be deselected.

Timer

You can use the timer to set the end time of a programme, allowing you to make use of night-time economy electricity rates for example. The start of a programme can be delayed by up to 24 hours.

To open the Timer sub-menu



- Press short cut button *Timer*. This opens the *Timer* sub-menu.

To select the end time of a programme



- Use the multi-function selector to select the programme end time, and confirm your selection. The programme end time will be adjusted to the next full or half hour. Once the end time has been entered, the start time of the programme will also appear.

To start the timer

- Press the *Start* button. The timer will count down in minutes until the start of the programme. If the time until the programme start is more than one hour, the drum will turn briefly every hour to prevent creasing.

While the timer is counting down, you can still . . .

. . . change the *Extra* options or drying levels.

. . . press the button and add or remove laundry. After shutting the door again, press the *Start* button.

. . . . alter the programme end time by pressing short cut button *Timer*.

To cancel the timer

- Press short cut button (*Cancel*) once, and then again (*Back*).

Programme chart

Cottons		Max. load: 6 kg*
Extra dry, Normal+, Normal**		
Fabric type	Single and multi-layered cotton fabrics such as towelling, jerseywear, T-shirts, underwear.	
Notes	<ul style="list-style-type: none"> – Select <i>Extra dry</i> for multi-layered and very thick fabrics. – Do not use <i>Extra dry</i> for jersey fabrics (e.g. T-shirts, underwear), as they have a tendency to shrink. 	
Extra options	Short, Low temperature (select this option for delicate fabrics with the ☐ symbol on the care label).	
Hand iron Δ, Hand iron ΔΔ**, Machine iron		
Fabric type	Cottons or linen fabrics, e.g.: table linen, bed linen, starched laundry.	
Note	To prevent laundry from drying out, it should be rolled up until you are ready for ironing.	
Extra options	Short, Low temperature (select this option for delicate fabrics with the ☐ symbol on the care label).	
Minimum iron		Max. load: 3 kg*
Normal+, Normal**, Hand iron Δ		
Fabric type	Minimum iron items made of cotton, synthetic or blended fabrics, e.g.: shirts, blouses, skirts and table cloths.	
Extra options	Short, Low temperature (select this option for delicate fabrics with the ☐ symbol on the care label).	

* Weight of dry laundry

** Note for test institutes:

Use this programme without selecting any Extra options for testing according to EN 61121 standard.

Programme chart

Delicates		Max. load: 2 kg*
Normal+, Normal		
Hand iron Δ, Hand iron $\Delta\Delta$, Machine iron		
Fabric type	Delicate items made of cotton, synthetic or blended fabrics, e.g.: jumpers, skirts, trousers, table cloths, shirts, blouses and evening wear with sequins and beading.	
Note	Laundry remains relatively crease-free for easier ironing.	
Extra option	Low temperature. (Low temperature cannot be deselected).	
Woollens handcare		Max. load: 2 kg*
Fabric type	Woollen fabrics	
Notes	<ul style="list-style-type: none"> – This programme only fluffs up woollen garments. They are not dried completely by this programme. – Remove garments as soon as the programme has finished and leave to finish drying at room temperature. 	
Extra option	Low temperature. (Low temperature cannot be deselected).	
Automatic		Max. load: 3.5 kg*
Normal+, Normal, Hand iron Δ		
Fabric type	Mixed load of cotton and minimum iron fabrics.	
Shirts		Max. load: 2 kg*
Normal, Hand iron Δ		
Garment	Shirts and blouses.	
Extra option	Low temperature. (Low temperature cannot be deselected).	
Smoothing		Max. load: 3 kg*
Fabric type	<ul style="list-style-type: none"> – Cotton and linen fabrics. – Minimum iron items made of mixed fibres, cottons or synthetics, e.g.: trousers, jackets, shirts. 	
Notes	<ul style="list-style-type: none"> – Smooths out creasing caused during the spin cycle in the washing machine. – Fabrics are not completely dried in this programme. Remove garments as soon as the programme has finished and leave to finish drying at room temperature. 	
Extra option	Low temperature. (Low temperature cannot be deselected).	

* Weight of dry laundry

Programme chart

Denim		Max. load: 3 kg*
Normal, Hand iron Δ		
Fabric type	Denim garments, e.g. jeans, jackets, skirts, shirts.	
Extra option	Low temperature. (Low temperature cannot be deselected).	
Cool air		Max. load: 6 kg*
Fabric type	Any item which only needs airing.	
Warm air		Max. load: 6 kg*
Fabric type	<ul style="list-style-type: none"> – "Voluminous" and multi-layered fabrics whose layers have different drying characteristics, e.g. jackets. – For drying individual items, e.g. bath towels, bathing costumes, tea-towels or small loads. 	
Note	– Do not select the longest drying time to start with. Check the items as you are drying them to find the optimum time.	
Tip	You can use the <i>Warm air</i> programme to help remove odours from cotton clothing which has been worn but it still clean (select a duration of between 1/2 and 1 hour). Items must be suitable for drying in a tumble dryer. Dampen the garments a little beforehand or add a fabric conditioner sheet. The Warm air programme will not be as effective at removing odours from any parts of the garments which are made of synthetic fibres.	
Extra option	Low temperature (select this option for delicate fabrics with the  symbol on the care label).	
Standard pillows - Normal (drying level)		1-2 pillows up to 40 x 40 cm
Large pillows - Normal (drying level)		1 pillow up to 80 x 80 cm
Item	Pillows suitable for drying in a tumble dryer, with feather, down or synthetic fillings.	
Note	Please observe the instructions on the care label. Pillows can still feel damp after being dried. You can use this programme several times until the pillow feels dry.	



* Weight of dry laundry

Programme chart

Silks handcare		Max. load: 1 kg*
Fabric type	Silks, e.g. blouses and shirts.	
Notes	<ul style="list-style-type: none"> – Smooths out creasing. – Fabrics are not completely dried in this programme. Remove garments as soon as the programme has finished and leave to finish drying at room temperature. 	
Extra option	Low temperature. (Low temperature cannot be deselected).	
Sportswear		Max. load: 2 kg*
Normal+, Normal, Hand iron Δ		
Garment	Sportswear which is suitable for drying in a tumble dryer.	
Outerwear		Max. load: 2 kg*
Normal, Hand iron Δ		
Garment	Outerwear which is suitable for drying in a tumble dryer.	
Proofing - Normal (drying level)		Max. load: 2 kg*
Item	For drying microfibre fabrics, ski wear, fine, closeweave cotton garments (poplin) or tablecloths which are suitable for drying in a tumble dryer and have been treated to provide a water and dirt resistant finish.	
Notes	<ul style="list-style-type: none"> – This programme includes a proofing fixing phase. – Only use proofing agents which are stated by the manufacturer as being "suitable for use on membrane textiles" as these contain fluorochemical compounds. – Do not dry items which have been treated with proofing agents containing paraffin. Fire hazard! 	

* Weight of dry laundry

Programme chart

Hygiene programmes	
<p>In the <i>Hygiene</i> programmes the temperature is held constant for a longer period of time to deactivate micro-organisms, e.g. germs or house dustmites and also reduce the number of allergens in the laundry.</p> <p>These programmes should not be interrupted as this would prevent the micro-organisms from being deactivated.</p>	
Cottons hygiene - Normal (drying level)	
Max. load: 6 kg*	
Fabric type	Cottons and linen fabrics, which will be in direct contact with the skin, e.g. underwear, nappies, towelling, bed linen, pillow and mattress covers.
Note	Only for drying fabrics which can withstand higher temperatures and which have the  symbol on the care label.
Minimum iron hygiene - Normal (drying level)	
Max. load: 3 kg*	
Fabric type	Minimum iron items made of synthetic or blended fabrics, e.g. skirts, shirts and blouses.
Note	Only for drying fabrics which can withstand higher temperatures and which have the  symbol on the care label.
Timed drying hygiene	
Max load: depending on fabric type	
Fabric type	<ul style="list-style-type: none"> – 6 kg* of items made of cotton or linen fabric. – 3 kg* of minimum iron items made of synthetic or blended fabric. – For airing individual items of laundry which are already dry or for deactivating lice, dustmites and micro-organisms in washable materials which are suitable for drying in a tumble dryer, e.g. stuffed toys, and which have the  symbol on the care label.

* Weight of dry laundry

Changing the programme sequence

Once a programme has started

- changing the programme

You cannot change to another programme once a programme has started (this prevents unintentional alterations).



You will need to cancel the current programme before you can select a new one.

- cancelling the programme and then selecting a different programme

- Press short cut button  *Cancel*.

The items will be cooled down, depending on the temperature reached and how long they have been dried for.

Finish will appear when you press short cut button  *Cancel* again.

- Switch the tumble dryer off by pressing the  button.
- Switch the tumble dryer on again by pressing the  button.
- Select another programme and start it.

- cancelling the programme and then removing the laundry

- Proceed as described in "Adding or removing laundry after a programme has started" below.
- Switch the dryer off after closing the door.

Adding or removing laundry after a programme has started

- Press the  button.
- Open the door.

 **Danger of burning:**
Do not touch the back of the drum when adding or removing items. The drum and the items can get very hot.

- Add or remove items as required.
- Close the door.
- Press the *Start* button.

Time remaining

The time left shown in the display may now vary from the actual drying time.

Electronic programme locking

Programme locking prevents the short cut buttons or the multi-function selector being used while drying is in progress.

The door is not locked and can be opened at any time.

To activate programme locking

- Once the programme has begun, press and hold the *Start* button until the following appears in the display:

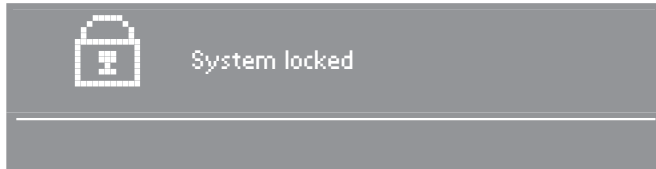

Now no more alterations can be made to the programme.

Programme locking is deactivated automatically at the end of the programme or by pressing button .

To deactivate programme locking

- Press and hold the *Start* button until the following appears in the display:



Cleaning and care

Emptying the condensed water container

The condensed water will be collected in the condensed water container unless the appliance has been set up to drain via the drain hose (see installation).

Empty the condensed water container after every drying programme.

The drying programme will be interrupted if the maximum level of the condensed water container is reached. A message will appear in the display.

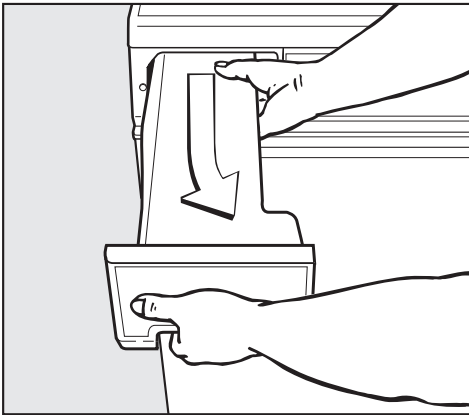

- Holding the container firmly in both hands, as shown, pull it out slightly towards the right-hand side.
- Hold the container in a horizontal position when carrying it.

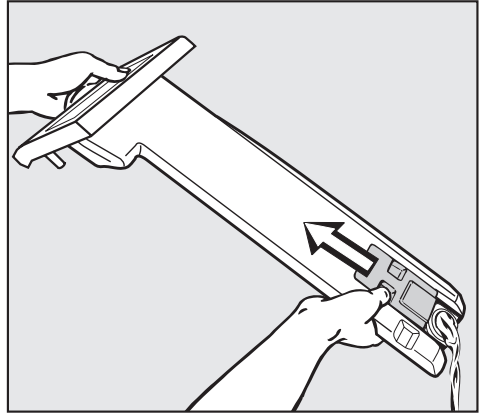

- Open the shutter and empty out the water.
- To replace the container, hold it at a slight angle (as when removing it) and push it in gently until you feel it click into position.
- To remove the message from the display, switch the dryer off and then on again.

Condensed water should not be consumed. It could lead to health problems for people and animals.

Condensed water can be put to household use (e.g. used in a steam iron or humidifier). To ensure that any residual particles of fluff in the condensed water are removed before use, pass it through a fine sieve or paper filter first.

Cleaning the fluff filters

The fluff which is created by the drying process is collected by the fluff filters in the door and the door opening. Clean the filters after **each** drying programme*.

Cleaning them whilst dry

Tip: You can also use a vacuum cleaner to remove the fluff.

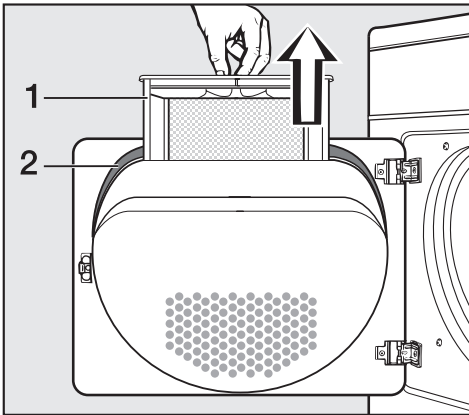

- Open the door and pull the fluff filter (1) out of the door as illustrated.

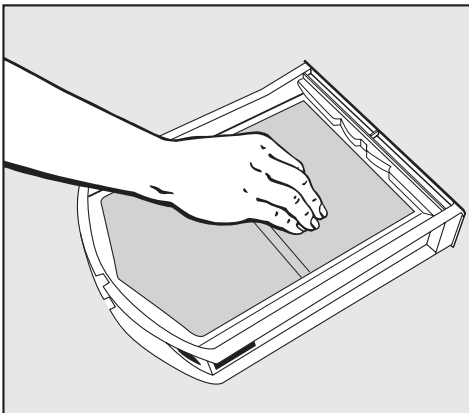

- Use your fingers to remove the fluff from the surface of the filter.
- Remove any fluff from the hollow part of the door opening. You could also use a cleaning brush which is available as an optional extra from your Miele dealer or the Miele Spare Parts Department, or use a vacuum cleaner.
- Also clean the door seal (2) with a damp cloth.
- Once clean, push the filter back into the door holder until it clicks into position. Ensure it is facing the correct way.

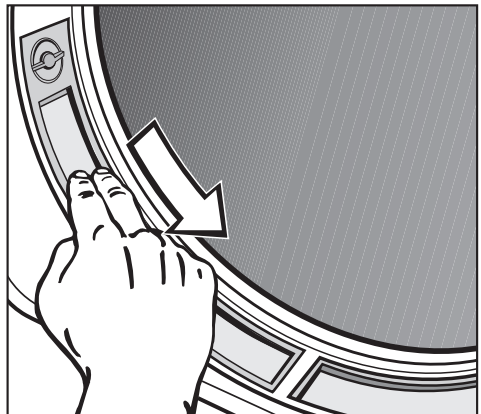

- Use your fingers or a vacuum cleaner to remove the fluff from the two fluff filters in the door opening.
- Close the door.

* Always check the fluff filters if the *Clean out airways* message appears.

Cleaning and care

Cleaning them with water

If there is a great deal of compacted fluff on any of the filters, they can be removed and cleaned under hot running water.

- Open the door and pull the fluff filter out of the door as described previously.

The two filters in the door opening can also be removed if you need to clean them with water.

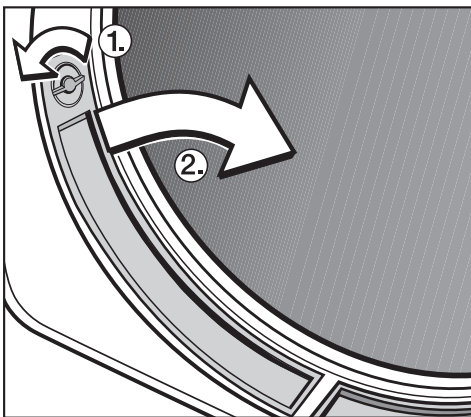

- Turn dial ① and pull the filter by the dial out of the door opening as shown ②. Do the same on the other side.
- Rinse all the filters under hot, running water.
- Then shake the filters until no more water droplets are visible.
- Dry the filters thoroughly with care.
- Clean the area underneath these filters, e.g. with a vacuum cleaner.

⚠ Do not replace them if they are damp or wet. Damp or wet filters could cause operational faults.

- Push the large filter back into the door holder until it clicks into position. Ensure it is facing the correct way.
- Replace the filters in the door opening by first inserting them at the bottom and then pressing them into place at the top.
- Lock both dials.

Cleaning the tumble dryer

Disconnect the tumble dryer from the mains electricity supply.

Miele branded cleaning and conditioning products are available to order via the internet on www.miele-shop.com.

- Clean the housing and control panel with a slightly damp cloth and a mild detergent or soapy water.
- The drum and other stainless steel parts can be cleaned with a suitable stainless steel cleaner following the manufacturer's instructions.

Do not use solvents, abrasive cleaners, glass cleaners or all-purpose cleaners. These could damage plastic surfaces and other parts. The tumble dryer must never be hosed down.

- Dry all parts with a soft cloth.

Cleaning and care

Cleaning the condenser unit

Detergent residue, hair and fine fluff from the dryer can get through the fluff filters and block the condenser unit. Dust from the room in which the dryer is installed can also get into the condenser unit and cause a blockage.

Check the condenser unit at least twice a year. Always check it if the *Clean out airways* message appears. If the dryer is used frequently then check the condenser unit after approx. 100 drying cycles. Clean it if necessary.

Removing the condenser unit

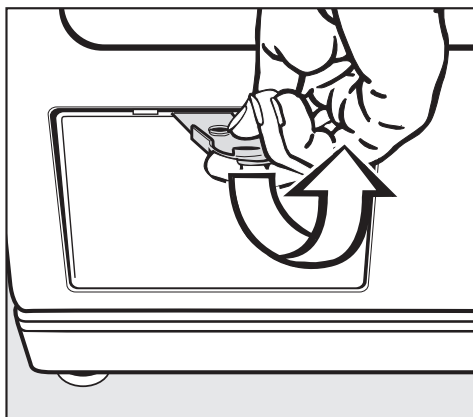

- Open the service panel. Hold the panel securely when doing this.
- Now remove the panel by pulling it diagonally upwards and place it to one side.

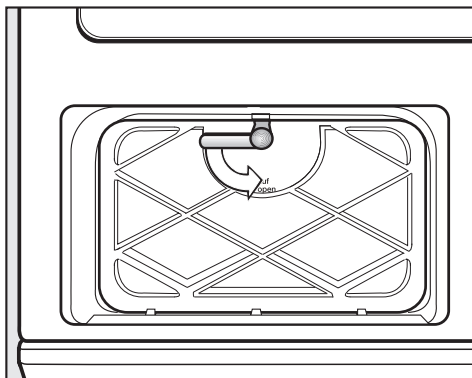

- Turn the lever on the inner cover downwards to the vertical position.
- Tilt the cover forwards.
- Remove it by pulling it diagonally upwards.

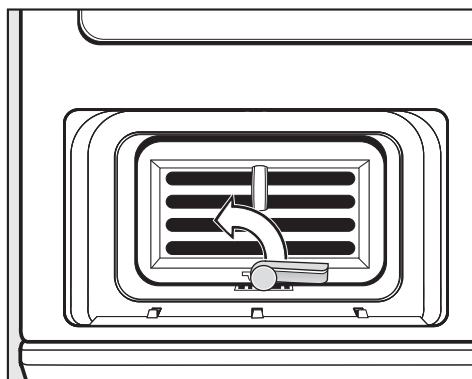

- Turn the lever on the condenser unit upwards to the vertical position.

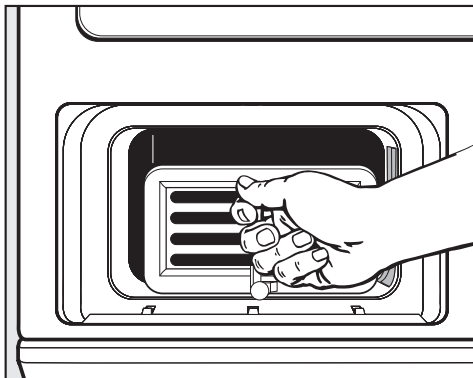

- Pull the condenser unit out of its housing by the handle.

Checking the condenser unit

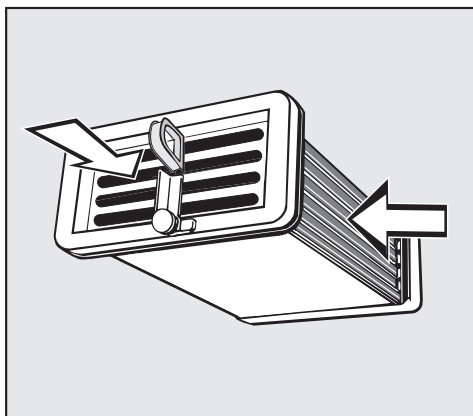

- Hold the condenser unit up to the light **as shown**.
- Check to see if there is any fluff inside it.
The arrows in the illustration above indicate where to look.

If you cannot see any fluff:

- Replace the condenser unit (see following page).

If you can see some fluff:

- Clean the condenser unit as described below.

Cleaning the condenser unit

- **When rinsing the condenser unit, make sure you position it as shown in the next two illustrations.**

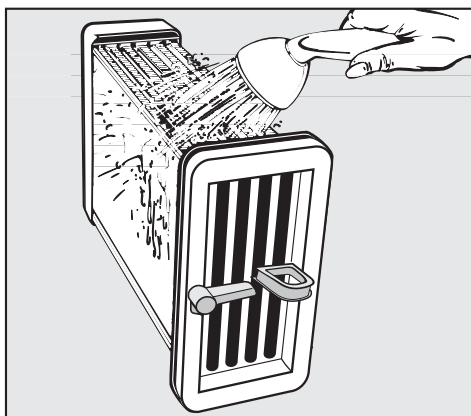

- Use a shower head or similar to rinse the unit out **as shown**.

Cleaning and care



- Then flush the unit through from the front.
- Check the condenser unit again for any visible fluff and if necessary flush it through again until it has all gone.
- Also make sure the rubber seals are clean.
The rubber seals must not be removed and must be free of kinks.

Checking and cleaning the condenser unit housing

- Remove any soiling still visible inside the housing unit by hand using a damp cloth. Do not try and access areas you cannot reach by hand!

Replacing the condenser unit

- **With the handle facing upwards,** push the condenser unit back into position in its housing.
- Turn the lever down to the horizontal position, making sure that the hook on the lever clicks into the groove.

When replacing the inner cover after cleaning, ensure that the rubber seal fits correctly into the groove.

- Replace the inner cover making sure the hooks locate correctly. Hold it at an angle and push it gently downwards.
- Then turn the lever upwards into the horizontal position to lock the cover.
- Replace the service panel and press the upper edge until it clicks into position.



 It is important to ensure that both the condenser unit and the cover are correctly positioned and locked, otherwise water may leak from the dryer.

Problem solving guide

With the help of the following notes, minor faults in the performance of the machine, some of which may result from incorrect operation, can be put right without contacting the Service Department.

 Repair work to electrical appliances should only be carried out by a suitably qualified person in strict accordance with current local and national safety regulations. Repairs and other work by unqualified persons could be dangerous. The manufacturer cannot be held liable for unauthorised work.

Fault messages in the display

Problem	Possible cause	Remedy
Machine locked. Enter code	Access via a code has been activated.	See "Settings menu".
 System lock	The electronic programme locking has been activated.	Press and hold the <i>Start</i> button until <i>Ready</i> appears in the display.
 Adjust the load The drum is empty or the laundry is too dry. + the programme is cancelled, the buzzer sounds	This is not a fault. The electronic unit has recognised that there is no laundry in the drum and cancelled the programme. Drying individual garments or items which are already dry can also cause the programme to be cancelled.	Use the Warm air programme (timed drying) to dry individual items. To delete the fault message: – Open the door or switch the dryer off and then back on again.
 Empty out the container or check the drain hose. + the programme is cancelled, the buzzer sounds	The condensed water container is full or there is a kink in the drain hose.	– Empty the condensed water container or check the drain hose. To delete the fault message: – Switch the dryer off and then back on again.

Problem solving guide



Problem	Possible cause	Remedy
<p>The following message appears after the programme has finished:</p> <p>Clean the airways Clean the fluff filter Check the airways</p>	<ul style="list-style-type: none"> – The dryer is not working efficiently or economically. Possible reason for this: The fluff filter is clogged with fluff or with detergent residues. – This message can also appear when using the <i>Large pillows</i> programme to dry a large pillow. The message does not indicate a fault in this instance. 	<ul style="list-style-type: none"> – Cleaning the filters is usually all that is required. However, if the message does not go out after you have cleaned the filters, then also check all the possible causes described under "The drying process goes on too long or even switches off". <p>To delete the fault message:</p> <ul style="list-style-type: none"> – Open and close the door. <p>You can adjust the setting which controls when or if the message <i>Clean out the airways</i> appears. See "Settings menu, Airways indicator").</p>
<p>Clean out the airways + the programme is cancelled, the buzzer sounds</p>	<p>See above for possible causes and their remedies.</p>	<ul style="list-style-type: none"> – Try to resolve the problem by following the instructions given above. – If the indicator light flashes again, contact the Miele Service Dept.
<p> Technical fault + the programme is cancelled, the buzzer sounds</p>	<p>There is a fault.</p>	<ul style="list-style-type: none"> – Switch the dryer off and then back on again. Try to start a programme. – If this warning appears again, contact the Miele Service Dept.
<p>i Programme finish time changed</p>	<p>This is not a fault.</p>	<p>Settings were changed while the timer was counting down to the start of a programme, or there was a power cut.</p>

Other problems		
Problem	Possible cause	Remedy
<p>The drying process goes on too long or even switches off.</p> <p>In some circumstances, <i>Clean out airways</i> still appears, even though the filters are clean.</p>	<p>Please check all the possible causes and switch the dryer off and then back on again.</p>	
	<p>Ventilation to and from the dryer may be insufficient (e.g. because it is installed in a small room). This has caused the temperature in the room to rise sharply.</p>	<p>Open a door or window while the machine is in operation for increased air flow.</p>
	<p>The fluff filters are clogged up with fluff or were still wet when they were replaced.</p>	<ul style="list-style-type: none"> – Remove any fluff. – The fluff filters must be completely dry.
	<p>The laundry has not been spun sufficiently.</p>	<p>Make sure that your laundry is thoroughly spun at the appropriate spin speed.</p>
	<p>The tumble dryer has been overloaded.</p>	<p>Do not exceed the maximum load for the programme selected.</p>
	<p>Metallic components, e.g. zips have prevented the dryer from registering the correct moisture level in the laundry.</p>	<ul style="list-style-type: none"> – Open zips next time. <p>If the problem occurs again, dry garments with long zips using the Warm air programme (timed drying).</p>
	<p>Detergent residues, hair and fine fibres can block up the condenser unit.</p>	<p>Check the condenser unit from time to time and clean it if necessary.</p>
<p>The vents below the door are blocked.</p>	<p>Remove any objects that are blocking the vents.</p>	
<p>The laundry is not sufficiently dry.</p>	<p>The load consisted of different fabrics.</p>	<ul style="list-style-type: none"> – Finish drying using the Warm air programme. – Select a different programme next time.

Problem solving guide

Problem	Possible cause	Remedy
<p>Water leaks from the machine after the condenser unit has been cleaned.</p>	<ul style="list-style-type: none"> – The inner cover of the condenser unit has not been locked properly and/or the condenser unit has not been positioned correctly. – Fluff has collected in the condenser unit housing. 	<ul style="list-style-type: none"> – Ensure that the condenser unit is positioned correctly and lock the inner cover. – Check the rubber seals. – Use a cloth to remove any visible fluff from the inside of the condenser unit housing.
<p>Items made of synthetic fibres are charged with static electricity after drying.</p>	<p>Synthetic fibres tend to attract static charge.</p>	<p>Static charge can be reduced by adding a fabric conditioner to the final rinse in the washing programme or a fabric conditioner sheet to the load when drying.</p>
<p>There is a build-up of fluff.</p>	<p>Fluff is principally the result of friction when garments are being worn and washed. Machine drying hardly causes any fluff to form and has been established by research institutes to have no appreciable effect on the lifetime of fabric.</p>	<p>Fluff is collected by the fluff filters and can be easily removed (see "Cleaning and Care").</p>
<p>Feather filled pillows smell after drying.</p>	<p>Feathers are a natural product and this is quite normal.</p>	<p>The smell will dissipate after sufficient airing.</p>

Problem solving guide

Problem	Possible cause	Remedy
The programme does not start and the display is dark.	No obvious cause.	<ul style="list-style-type: none"> – Is the dryer switched on? – Is the plug correctly inserted into the socket and switched on? – Is the door closed properly? – Has the fuse or circuit breaker tripped?
The interior drum lighting does not come on.	The lighting switches off automatically (to save energy).	Switch the dryer off and then on again.
	The lamp needs changing.	Change the lamp as described at the end of this section.
Power cut	Once power has been restored, switch the tumble dryer on with the  button to continue the programme.	
The display is in a different language.	A different language has been selected.	Set the language you want. The flag symbol  will guide you. See <i>Language</i>  at the end of this booklet.
The <i>Start</i> button flashes when a programme is being selected.	<p>This is not a fault.</p> <p>The flashing indicates that a programme can be started.</p>	After the programme has started, the flashing will change to a constant light.
The display is dark. The ring around the multi-function selector does not light up. The <i>Start</i> button is flashing slowly.	The display has switched off automatically to save energy (Standby mode).	The display and the multi-function selector will light up when one of the buttons is pressed.
	If the problem persists, there is a fault.	Contact the Miele Service Department.

Problem solving guide

Changing the lamp

Disconnect the tumble dryer from the mains electricity supply.

- Open the door.

You will find the interior lamp cover at the top of the drum aperture.

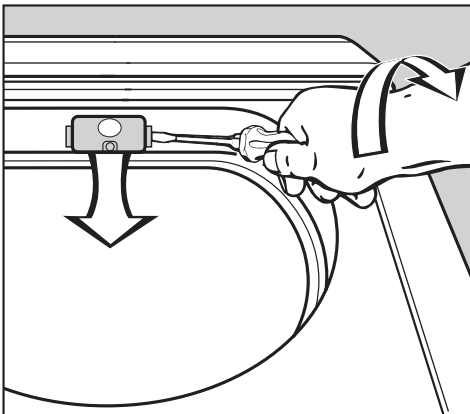

- Insert a suitable tool, such as a wide bladed screwdriver, under the side edge of the lamp cover as illustrated.
- Apply a little pressure and whilst doing so turn your wrist in the direction of the arrow to open the cover.

The cover will open downwards.

The temperature resistant lamp should only be ordered from your Miele Dealer or the Miele Spare Parts Department.

The lamp specification and maximum wattage is stated on the data plate and on the lamp cover.

- Replace the lamp.
- To close the cover push it upwards and press it on the left and right until you hear it click into position.

⚠ Ensure that it is fitted into position securely, as any moisture could cause a short circuit.

Repairs

In the event of any faults which you cannot remedy yourself, please contact

- your Miele dealer or
- the Miele Service Department (see back cover for contact details).

When contacting your dealer or the Service Department, please quote the model and serial number of your appliance, both of which are shown on the data plate situated on the right hand side below the drum aperture.

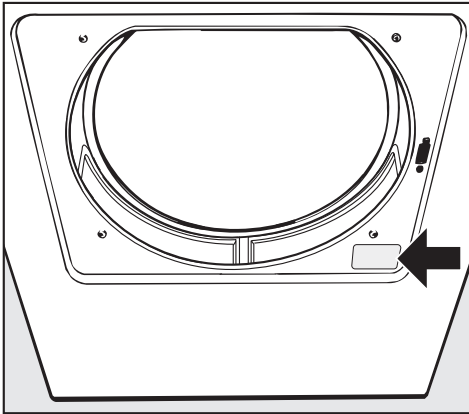

N.B. A call-out charge will be applied for service visits where the problem could have been resolved as described in these instructions.

Future updates (PC)

The indicator or check light marked **PC** on the fascia panel is the interface used by the Miele service technicians during service work for testing purposes and for updating the appliance's programme data.

Appliance guarantee

Please see the guarantee card supplied with your appliance.

Optional accessories

Optional accessories for this dryer are available from your Miele Dealer, the Miele Spare Parts Department or via the internet at www.miele-shop.com.

Please note that telephone calls may be monitored and recorded for training purposes.

Installation

Front view

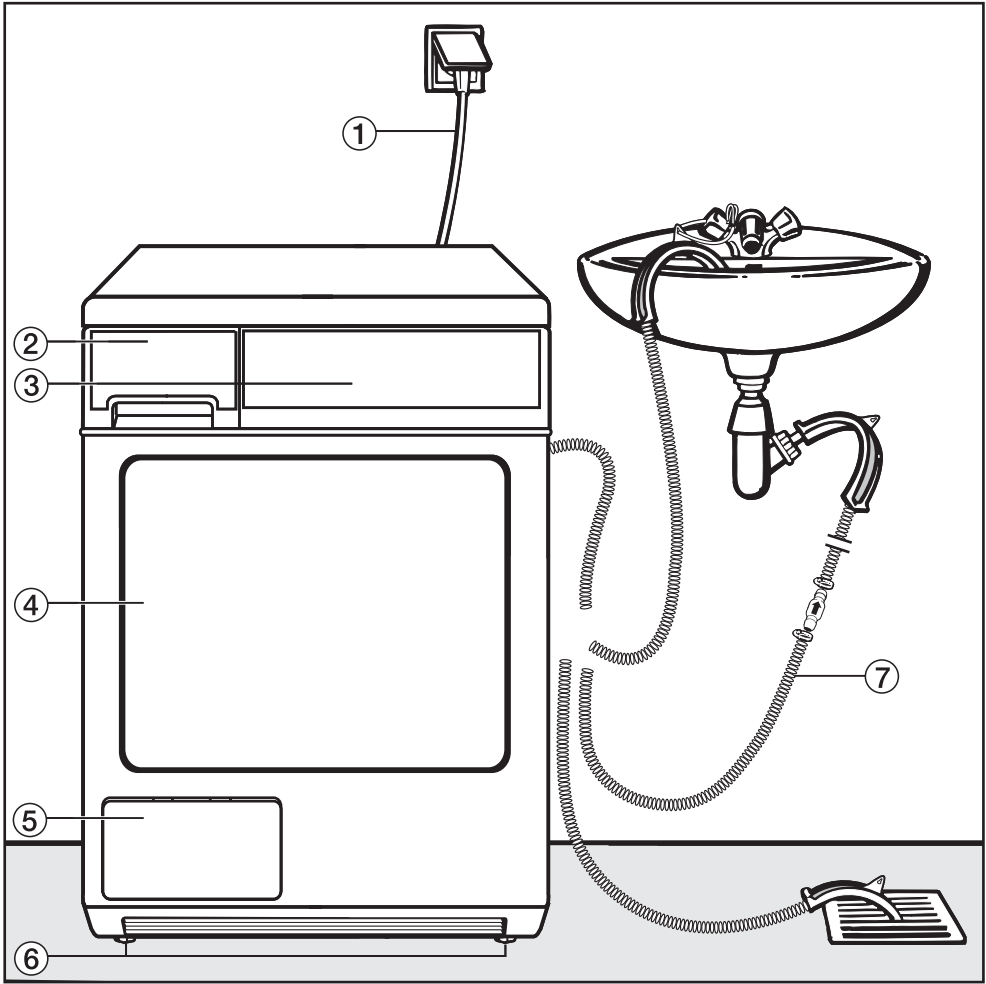

- ① Mains connection cable
- ② Condensed water container
- ③ Control panel
- ④ Door
- ⑤ Service panel for condenser unit
- ⑥ Four height-adjustable screw feet
- ⑦ External drainage options (e.g. via wash basin, wash basin drain outlet, or gully. See "External condensed water outlet").

Rear view

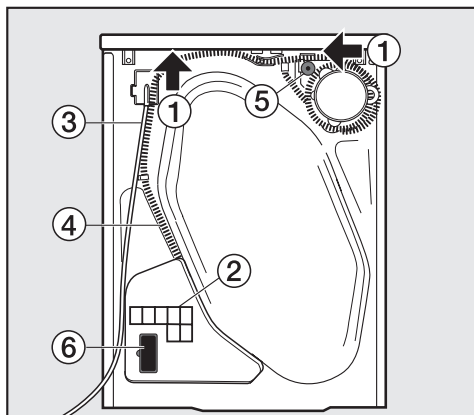

- ① Protruding lid for holding when moving the machine (see arrows)
- ② Air inlet vent for cooling the condenser unit
- ③ Mains connection cable
- ④ External drainage of the condensed water
- ⑤ Accessories for connection to a sink drain outlet
- ⑥ Slot for Miele@home communication module

Installation site

 Make sure the dryer door can be opened without hindrance after installation.

Transporting the machine to its installation site

When moving the machine, you can hold it by the lid where it protrudes to the rear of the dryer. To manoeuvre the dryer out of its packing case to its

installation site you will also need to hold it by the front feet.

Building under a continuous worktop / in a kitchen run

 A **building-under kit*** with a coverplate to replace the machine lid is required. It must be fitted by a suitably qualified person to ensure electrical safety.

N.B. If you wish to push your machine under a worktop and there is space to do this **without removing the lid** the building under kit is not necessary. Otherwise the building under kit is essential.

- The building-under kit is supplied with its own installation instructions.
- N.B. When built under drying times may be longer.
- The electrical socket must be located in an accessible position near the machine.

With niche heights of:

- 830-840 mm, longer screw feet* are required.
- 870-885 / 915-930 mm, one or two raising kits* are required.

* accessory available to order

Replacing the lid

If the lid has been removed in order to fit a coverplate, ensure that, if the lid is ever replaced, it fits securely into the rear holders. Otherwise, it is not properly secure for transport.

Installation

Levelling the machine

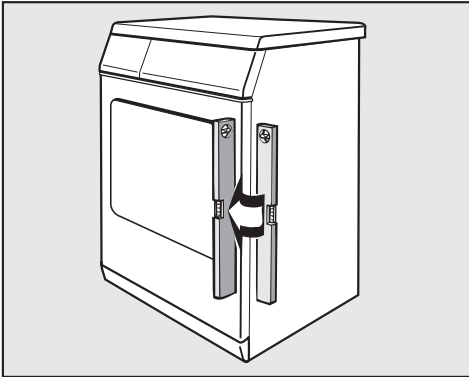

The machine must be perfectly level to ensure safe and proper operation.

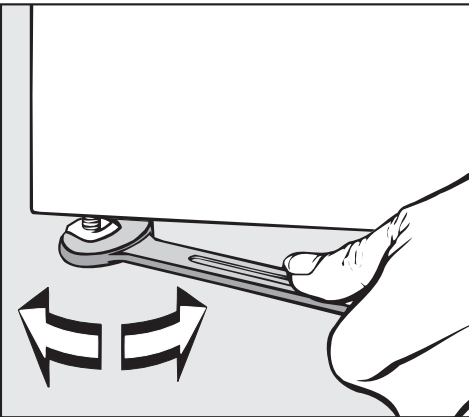

- The screw feet can be adjusted to compensate for any unevenness in the floor.

⚠ The air inlet and outlet vents on the front of the machine must not be covered as this would prevent sufficient ventilation for cooling the condenser unit.

⚠ Do not block the gap between the bottom of the tumble dryer and the floor with plinth facings, deep pile carpet etc. This would hinder a sufficient flow of air to the dryer.

Room in which the dryer is located

Air taken in for use in the drying process will be warm when it is expelled from the front of the dryer. This expelled air heats up the air in the room. It is therefore very important to ensure that the room is adequately ventilated, particularly if the dryer is located in a small room. Otherwise running times and energy consumption could be increased.

Washer-dryer stack

The tumble dryer can also be combined with a Miele washing machine in a washer-dryer stack. The appropriate "WTV" stacking kit (available to order) to match your dryer is required.

⚠ Stacking kits must only be installed by a suitably qualified fitter.

Before moving the machine again (e.g. when moving house)

After each use a small quantity of condensed water will collect in the area around the pump. This water can run out if the machine is tipped up when it is being moved. It is a good idea to run the *Cool air* programme for approximately 1 minute before moving the machine. Any remaining condensed water will then be fed into the condensed water container or out through the drain hose.

External condensed water outlet

General notes

When drying is in progress, condensed water is pumped into the condensed water container through the drain hose at the back of the dryer. The condensed water can also be drained off directly if the tumble dryer is installed near a sink, drain outlet etc. so that the condensed water container does not have to be emptied.

Drain hose length 1.50 m
Maximum delivery head 1.50 m
Maximum drain hose length 4.00 m

⚠ If the on-site water drainage system is not fitted with a non-return valve or an appropriate air gap, one must be fitted to prevent the risk of back-flow. (See "Installation conditions requiring a non-return valve").

The following optional accessories are available:

- an extension hose
- a non-return valve kit for connection to an external condensed water outlet (includes an extension hose). Maximum delivery head with non-return valve fitted: 1.00 m

Arranging the drain hose

⚠ Do not pull on the drain hose and do not stretch it or allow it to become kinked as it could get damaged.

- There will be a small amount of residual water in the drain hose. Have a container ready to collect this.

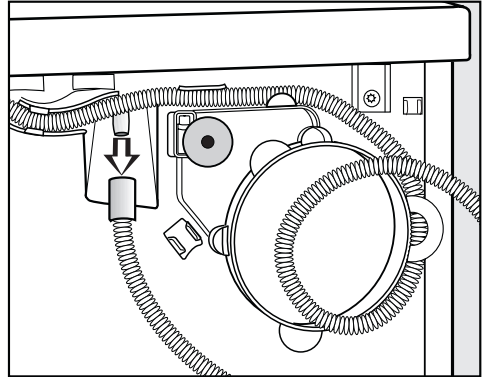

- Pull the hose off its connection (see arrow).
- Allow any residual water to run into the container.

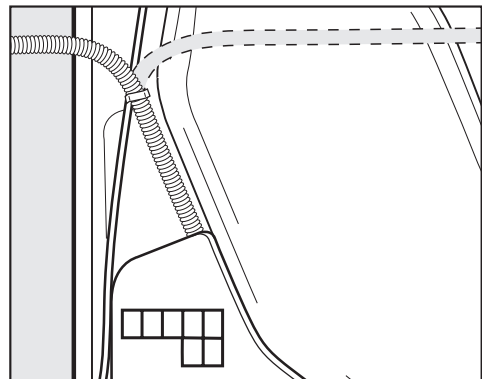

- Unwind the hose and pull it carefully out of the holders.
- Position the hose to the right or left hand side as necessary.

Leave the hose in the middle holder to prevent it from becoming kinked inadvertently.

Installation

External drainage via a sink or gully

- See "Front view" illustration.

 If you want to drain the water off into a sink you will need to secure the hose carefully, e.g. by tying it to a tap to make sure it cannot slip during use. Otherwise there is a risk of overflowing water which could cause damage.

- Use the bow-shaped guide to prevent the drain hose from becoming kinked.

Installation conditions requiring a non-return valve

 Certain installation conditions require the fitting of a **non-return valve for external water connection** (available as an optional accessory). A non-return valve will prevent the risk of back-flow out of the dryer which could cause damage.

A non-return valve is required:

- If the tumble dryer is connected to a sink drain outlet (see the following section).
- If the tumble dryer is connected to a drainage system **already in use** by another appliance, e.g. a dishwasher or washing machine.

Example: Connection to a sink drain outlet

The drain hose with non-return valve fitted can be connected directly to a suitable sink drain outlet.

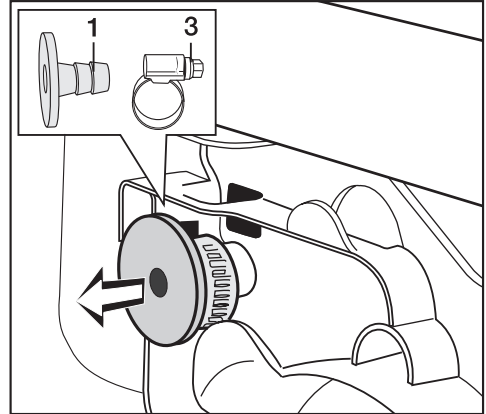

- Remove the following from the back of the dryer at the top:
Adapter **1** and hose clip **3** behind it.

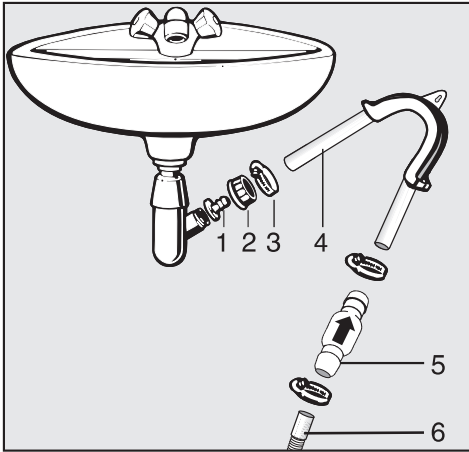

- 1 Adapter
- 2 Nut
- 3 Hose clip
- 4 End of the hose
- 5 Non-return valve
- 6 Tumble dryer drain hose

- Fit adapter **1** to the sink drain outlet using nut **2**.

If this nut has a flat disc in it you should take the disc out first.

- Attach the end of hose **4** to adapter **1**.
- Use a screwdriver to tighten hose clip **3** up close to the nut.

 Non-return valve **5** has to be fitted with the arrow pointing in the direction of flow (i.e. towards the sink). Otherwise water will not drain out of the appliance.

- Fit non-return valve **5** to tumble dryer drain hose **6** (make sure it is fitted in the correct direction - see arrow on non-return valve).
- Secure the non-return valve using hose clips.

Electrical connection

Electrical connection U.K.

All electrical work should be carried out by a suitably qualified and competent person, in strict accordance with current national and local safety regulations (BS 7671 in the UK).

Ensure power is not supplied to the appliance until after installation work has been carried out.

The appliance is supplied with a mains cable with moulded plug ready for connection to a 230-240V mains supply. Please ensure the connection data quoted on the data plate match the household mains supply.

Connection should be made via a suitable switched socket which is easily accessible after installation.

For extra safety it is advisable to protect the appliance with a suitable residual current device (RCD). Contact a qualified electrician for advice.

Do not connect via an extension lead. Extension leads do not guarantee the required safety of the appliance (e.g. danger of overheating).

Non-rewireable plugs BS 1363

The fuse cover must be refitted when changing the fuse, and if the fuse cover is lost, the plug must not be used until a suitable replacement is obtained. The colour of the correct replacement cover is that of the coloured insert in the base of the plug, or the colour that is embossed in words on the base of the plug (as applicable to the design of plug fitted).

Replacement fuses should be ASTA approved to BS 1362 and have the correct rating. Replacement fuses and fuse covers may be purchased from your local electrical supplier.

**WARNING: THIS APPLIANCE
MUST BE EARTHED**

Consumption data

Programme	Load	Final spin speed	Energy	Duration
		in a domestic washing machine		
	kg*	rpm	kWh	Minutes
Cottons Normal	6.0	1000 (60 % residual moisture)**	3.30	89
		1200	3.00	81
		1400	2.85	78
		1600	2.55	70
		1800	2.50	69
Cottons Hand iron ΔΔ	6.0	1000 (60 % residual moisture)**	2.65	71
		1200	2.35	63
		1400	2.20	60
		1600	1.85	52
		1800	1.80	51
Minimum iron Normal	3.0	1200 (40 % residual moisture)**	1.20	37
Minimum iron Hand iron	3.0	1200	1.00	32
Delicates Normal	2.0	800	1.40	95
Automatic Normal	3.5	800	2.10	85
Shirts Normal	2.0	600	1.15	41
Denim Normal	3.0	900	2.00	96
Woollens handcare	2.0	1000	0.15	4
Silks handcare	1.0	400	0.15	5
Smoothing	3.0	1000	0.30	8
Sportswear Normal	2.0	600	1.45	65
Outerwear Normal	2.0	800	1.95	105
Proofing	2.0	800	1.55	72
Cottons hygiene	6.0	1000	3.70	118
Minimum iron hygiene	3.0	1200	1.45	58
Large pillows	1.2	1200	2.75	198

* Weight of dry laundry

** EN 61121:2005 test programme

All data without a "star" against it was calculated using EN 61121:2005.

Before testing in accordance with EN 61121, dry a 3 kg load of cotton laundry with 70% residual moisture as per the above standard using the Cottons Normal programme without any extra options.

Consumption data can vary from the nominal values given above depending on the size of the load, types of textiles, residual moisture levels after spinning, fluctuations in the electricity supply and any extra options selected.

Technical data

Height	850 mm
Width	595 mm
Depth	587 mm
Depth with door open	1062 mm
Height for building under	820 mm
Width for building under	600 mm
Depth for building under	600 mm
Suitable for pushing under a worktop	Yes
Suitable for stacking	Yes
Weight	51 kg
Drum volume	111 litres
Maximum capacity	6 kg dry weight
Capacity of condensed water container	approx. 3.5 litres
Drain hose length	1.5 m
Maximum delivery head	1.5 m
Maximum drain hose length	4 m
Length of connection cable	2 m
Voltage	see data plate
Connected load	see data plate
Fuse rating	see data plate / plug
Lamp wattage	see data plate
Energy consumption	see "Consumption data"
Test certificates awarded	see data plate

Settings menu for changing default settings

The Settings menu is used to alter the dryer's electronics to suit different requirements.
Settings can be altered at any time.

Settings menu

To open the *Settings* menu

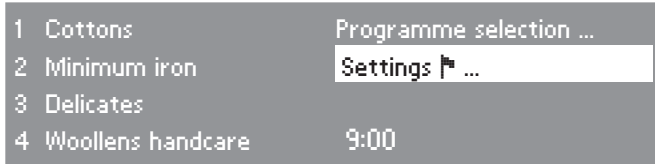

- Select *Settings*  from the entry menu and confirm your selection with the multi-function selector.

To select a setting

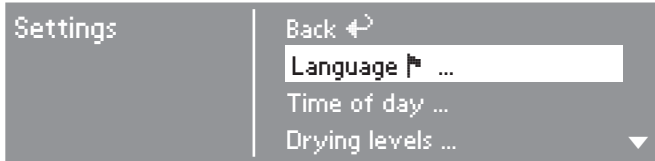

- Select the setting you want to change, and confirm your selection.

If you do not make a selection in the sub-menu within approx. 15 seconds, the display will revert to the main menu.

To close the *Settings* menu

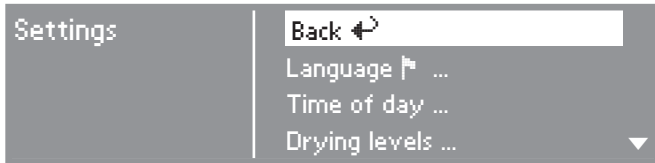

Language

The display can be set to appear in one of several different languages.

A tick ✓ will appear beside the language to show that it has been set.

The flag  after the word *Language* acts as a guide to prevent a language which will not be understood from being set.

Time of day

First select either a 24 hour or 12 hour clock.
Then set the current time of day.

To select a 24 hour or 12 hour clock

- Select either the 24 hour or the 12 hour clock, and confirm your selection.

The display will then change to the screen for setting the time of day.

To set the time of day

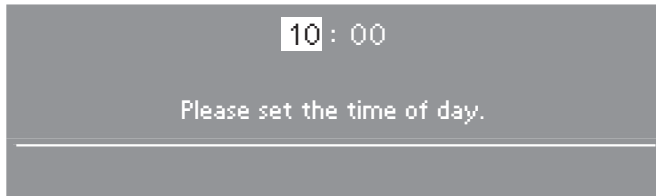

- Use the multi-function selector to select the hour and confirm your selection. Now set the minutes. Pressing the multi-function selector again saves the time of day in memory.

The time of day can be changed at any time later on by:

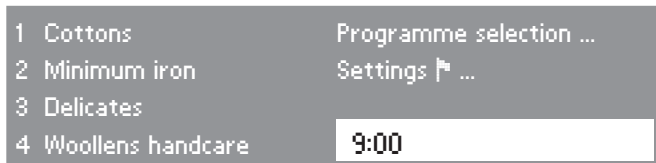

- Highlighting the time of day in the Entry menu and confirming your selection.

The display will then change to the screen for setting the time of day.

Settings menu

Drying levels

You can alter the drying levels for the *Cottons* and *Minimum iron* programmes.

The bar chart shows you the setting.
Factory default: a medium setting.

Depending on the setting, the programme duration will be shorter (Dampener) or longer (Drier).

Extended cool down

The cooling down phase which takes place before the end of a programme can be lengthened if required. This makes the garments easier to handle.

The bar chart shows you the setting.
Factory default: 0 mins (normal cooling down period)

You can select an extended cool down time in 2 minute increments up to a maximum of 18 minutes.

You cannot extend the cooling down time for the Warm air, Cool air, Timed drying hygiene, Woollens handcare, Silks handcare or Smoothing programmes.

Airways indicator

Fluff should be removed after drying. The *Clean out airways* message will remind you to clean the filters when a certain amount of fluff has collected in them. You can decide at what level of fluff this reminder should be given.

You will have an idea of how often this should be done after a few drying programmes.

Off = *Clean out airways* does not appear

Heavy = *Clean out airways* only appears when there is a heavy build-up of fluff

Normal = Factory default setting

Light = *Clean out airways* appears when there is only a small build-up of fluff

A tick ✓ will appear beside the option to show that it has been set.

Anti-crease action

The drum will continue to rotate at intervals for one hour to prevent laundry creasing, if you do not wish to remove it immediately.

A tick ✓ will appear beside the option to show that it has been set.

Factory default: On.

The anti-crease function cannot be used with the *Woolens handcare* programme.

Code

The code prevents your machine being used without your knowledge.

When the code has been activated, you have to enter a code after switching the dryer on. Otherwise the dryer cannot be operated.

The door is not locked and can be opened at any time.

To activate the code

- Select *Activate* and confirm your selection.

Settings menu

To enter the code

The display will now request that a code is entered. The code is **250** and cannot be altered.



- Turn the multi-function selector until the number **2** appears. Then press it to confirm your selection of this number. Now enter the second number.
- Repeat the process until all three numbers have been entered.

After the last number has been entered, you must confirm the code with OK.



- Confirm the code, then switch the dryer off.

To use the dryer when the code is activated

When the machine is switched on again, the display will request the code.

- Enter code 250 as described above and confirm the entry.

The dryer is now unlocked and ready for use.

To deactivate the code

Proceed as for activating the code.

Buzzer

A buzzer sounds (at intervals for a maximum of 1 hr) to let you know the programme has finished.

Off = The buzzer will always sound when there is a fault, even if it has been switched off.

Normal = The buzzer sounds at the end of a programme.

Loud = The buzzer sounds louder at the end of a programme.

A tick ✓ will appear beside the option to show that it has been set.

The machine is delivered with the option: Normal, set as standard.

Keypad tones

An audible tone sounds when the *Start* button, a short cut button or the multi-function selector is pressed.

A tick will appear beside the option to show that it has been set.

The machine is delivered with the option: Off, set as standard.

Display contrast

There are ten different display contrast settings.

The bar chart shows you the setting. The factory default setting is a medium setting.

Settings menu

Standby

To save energy, the display goes out after 10 minutes and the *Start* button flashes slowly.

There are two options:

Active (the machine is delivered with this option selected)

Standby is activated:

- if a programme is not selected 10 minutes after the machine has been switched on.
- 10 minutes after the *Start* button has been pressed.
- 10 minutes after the end of a programme.

Not in current programme

Standby is activated:

- if a programme is not selected 10 minutes after the machine has been switched on.
- 10 minutes after the end of a programme.

Operating the multi-function selector or one of the short cut buttons switches the display back on again.

A tick ✓ will appear beside the option to show that it has been set.

The following settings only appear if Communication module XKM 2000 has been fitted to the dryer.

Miele@home

This communication enabled dryer can transmit programme data through the power lines to the Miele@home system. The dryer must be signed on to the Miele@home system.

Please read the separate operating instructions supplied with the Miele@home system before you sign on the dryer.

Signing on

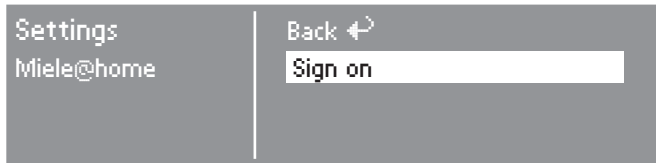

- Select *Sign on* and confirm your selection.

The signing on process will begin. If signing on is successful, the following will appear after a while:



When the dryer is in operation, programme data will be transmitted from it over the power lines.

Settings menu

If signing on is unsuccessful:

- Check that the Miele@home system is active.
- Activate the signing on of a new appliance on the Miele@home system.
- Repeat the signing on process on the dryer.

Signing off

You can sign off the dryer if you no longer want the programme data to be transmitted. Proceed as for signing on.

Switching off time of day synchronisation

When the signing on process has been successful, the time of day on the dryer will be synchronised automatically with the Miele @home system time of day. This is useful for example when changing from summer time to winter time as you only have to change the time on the Miele@home system.

You can turn this feature off if you want the time on your dryer to be different from the time on the Miele@home system.

To do this, select the *Time of day* sub-menu from the *Settings* menu.

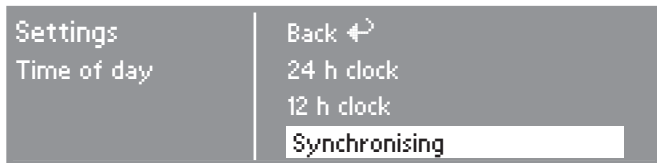

- Select *Synchronising* and confirm your selection.

This opens the Synchronising sub-menu.

- Select *Off* and confirm your selection.

Synchronisation is deactivated.

Remote access

This option will be made available in the future.

When available it will enable the dryer to be switched on remotely and monitored using another appliance (e.g. a computer or mobile phone).

Your Miele Dealer will be able to tell you when it becomes available.

It offers two options:

On

Remote access active. The dryer can, if wished, be operated from a remote source. (This option should only be selected if your computer / mobile phone is configured for this).

Off (the machine is delivered with this option selected as standard)

Remote access not active.

The entry menu will look like this when remote access is activated:

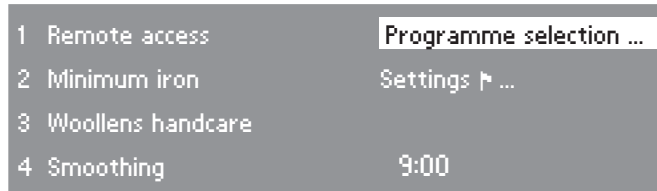

Short cut button  is automatically set up for *Remote access*.

The programme previously allocated to button  remains stored in memory for this button. It will reappear when the remote access function is deactivated.

Settings menu

You have two options:

Remote access

You can select and start a programme using a mobile phone or computer.

- Press short cut button .
- Press the *Start* button.

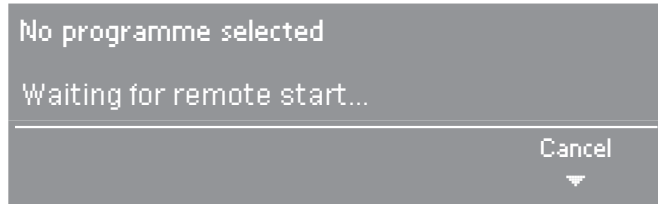

Remote start

You have to select the programme on your dryer and then start it later on using your computer or mobile phone.

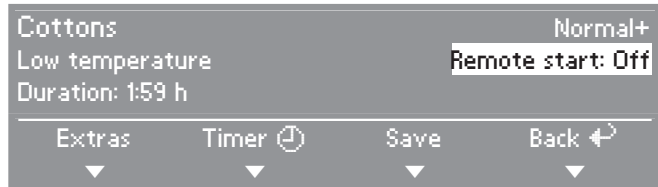

- Select a programme.
- Turn the multi-function selector to *Remote start* and press it to confirm your selection.
- Switch remote start on.
- Press the *Start* button.

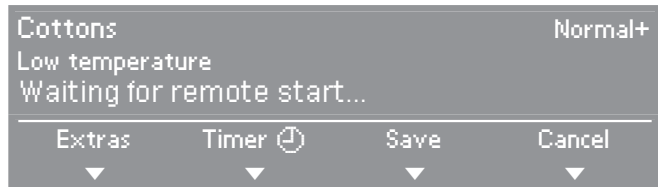

Miele

United Kingdom

Miele Co. Ltd.
Fairacres, Marcham Road
Abingdon, Oxon, OX14 1TW
Tel: 0845 365 0555
Fax: 0845 365 0777
Customer Contact Centre Tel: 0845 365 6600
E-mail: info@miele.co.uk
Internet: www.miele.co.uk

Australia

Miele Australia Pty. Ltd.
ABN 96 005 635 398
1 Gilbert Park Drive, Knoxfield, VIC 3180
Tel: (03) 9764 7130, Fax: (03) 9764 7149
Internet: www.miele.com.au

China

Miele Shanghai
Suite 4105-06, Plaza 66
1266 Nanjing Road West
Jing An District
Shanghai 200040, PRC
Tel: +86 21 6288 4200, Fax: +86 21 6288 4100
E-mail: mieleshanghai@cn.miele.com
Internet: www.miele.cn

Hong Kong

Miele (Hong Kong) Limited
AIA Plaza, 24th Floor
18 Hysan Avenue
Causeway Bay
Tel: +852- 2610-1331, Fax: +852-2610-1013
E-mail: mielehk@miele.com.hk
Internet: www.miele.hk

India

Miele Appliances India Pvt. Ltd.
Ground Floor, Copia Corporate Suites
Plot No. 9, Jasola
New Delhi – 110025
Tel: 011-46 900 000, Fax: 011-46 900 001
E-mail: customer care@miele.in
Internet: www.miele.in

Ireland

Miele Ireland Ltd.
Broomhill Road, Tallaght, Dublin 24
Tel: (01) 461 0710, Fax: (01) 461 07 97
E-Mail: info@miele.ie
Internet: www.miele.ie

New Zealand

Miele New Zealand Limited
Unit L, 10-20 Sylvia Park Road
Mt. Wellington, 1060, Auckland, NZ
Tel: 0800 264 353, Fax: 0800 463 453
Internet: www.miele.co.nz

Singapore

Miele Southeast Asia
Miele Pte. Ltd.
163 Penang Road
04 - 02/03 Winsland House II
Singapore 238463
Tel: +65 6735 1191, Fax: +65 6735 1161
E-Mail: infosea@miele.com.sg
Internet: www.miele.sg

South Africa

Miele (Pty) Ltd
63 Peter Place, Bryanston 2194
P.O. Box 69434, Bryanston 2021
Tel: +27 (0) 11 548-1900
Fax: +27 (0) 11 548-1935
E-mail: info@miele.co.za
Internet: www.miele.co.za

United Arab Emirates

Miele Appliances Ltd.
P.O. Box 11 47 82
Gold & Diamond Park
Sheikh Zayed Road
Building 6 / Offices Nos. 6-214 to 6-220
Dubai
Tel: +971-4-341 84 44
Fax: +971-4-341 88 52
E-Mail: info@miele.ae
Internet: www.miele.ae