

Operating Instructions

Before first use of these unit
Please read these Operating Instructions
and act in accordance with them

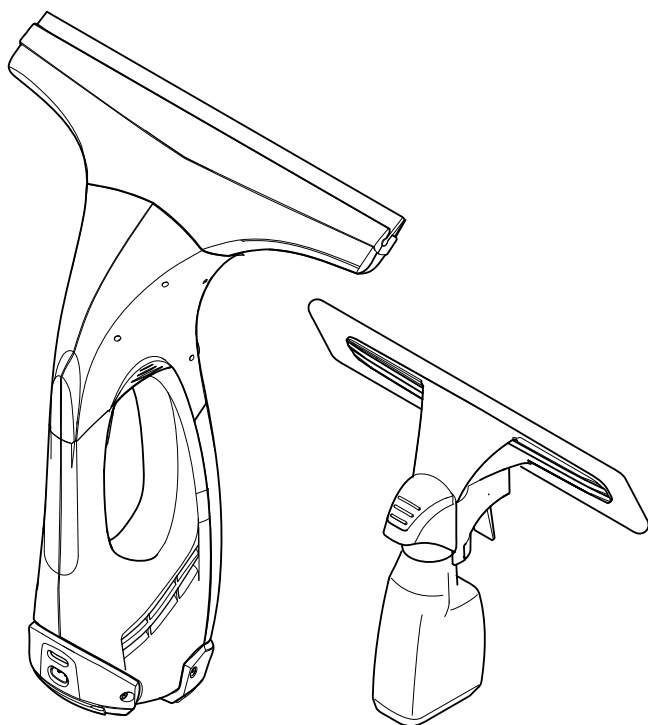

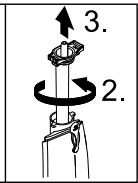
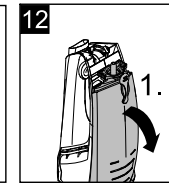
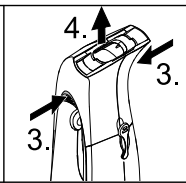
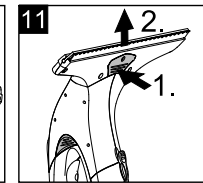
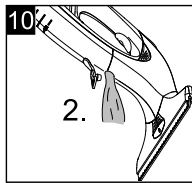
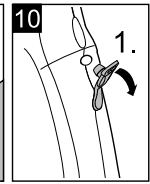
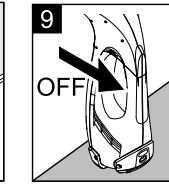
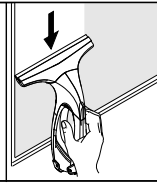
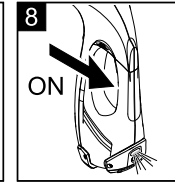
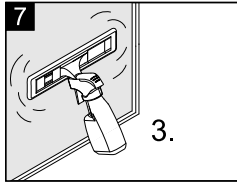
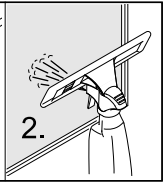
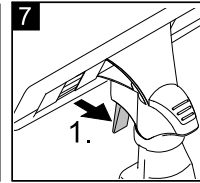
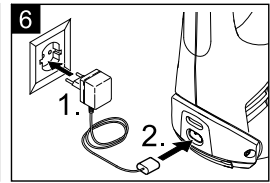
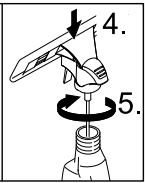
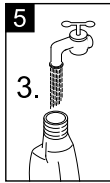
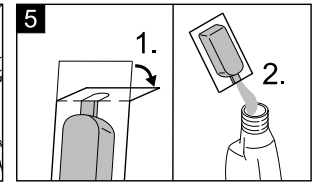
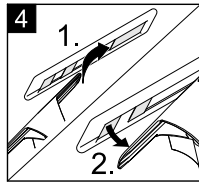
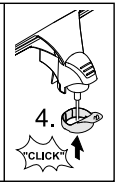
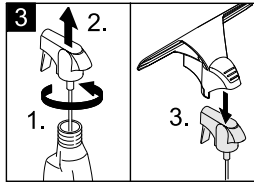
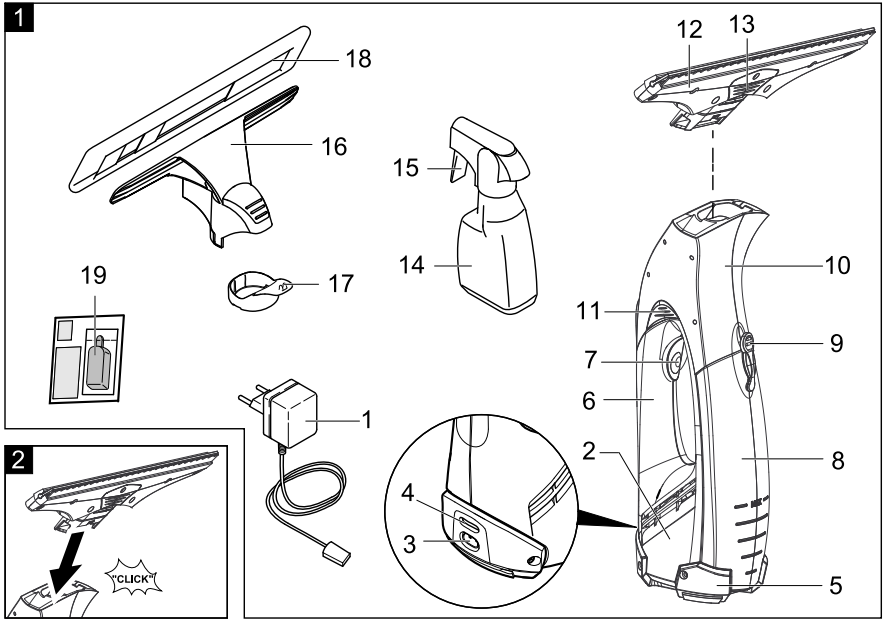

Contents

Safety instructions	3
Start up	4
Finish up your work / clean appliance	5
Troubleshooting	6
Specifications	6
Disposal of Appliances	6

Dear Customer,



Please read and comply with these original instructions prior to the initial operation of your appliance and store them for later use or subsequent owners.

Proper use

- Use this battery operated appliance only for personal use, for cleaning moist, smooth surfaces such as windows, mirrors or tiles. Not meant for the vacuum of dust.
- The appliance is not intended to vacuum up larger amounts of fluids from horizontal surfaces, such as from a tipped drinking glass (max. 25 ml).
- Only use this appliance with conventional window cleaners (no spirit, no foam cleaners).
We recommend: Window cleaner concentrate made by KÄRCHER (see chapter "Accessories").
- Please use this appliance only with accessories and spare parts approved by KÄRCHER.

Any use extending beyond this is not considered as proper use. The manufacturer is not liable for any losses resulting from this; the user alone bears the risk for this.

Safety instructions

- This device is not intended for use by persons (including children) with reduced physical, sensory or mental abilities or lacking experience and/or knowledge, unless they are supervised by a person responsible for their safety or are instructed by these persons on the use of the device. Children should be supervised, to ensure that they do not play with the device.
- Do not insert objects into the air louvers.
- Do not spray jet into eyes.
- Do not direct the spray jet directly on equipment containing electrical components, such as the interior of ovens.
- Prior to using this appliance on sensitive (high shine) surfaces, test the microfibre wiping pad at an inconspicuous location.

Information regarding the battery

- **Short circuit hazard!** Do not insert conductive objects (such as screwdrivers or similar) into the charger plug.
- You may recharge the battery using only the original charger provided with the appliance or a charger approved by KÄRCHER.

Tips for using the battery charger

- In case of visual damage, replace the charger with charger cable immediately by original parts.
- The voltage indicated on the type plate must correspond to the supply voltage.
- Only use and store the charger in dry rooms, ambient temperature 5 - 40° C.
- Never touch the mains plug with wet hands.

Information regarding the transport

- The battery has been tested as per the relevant directives for international transport and can be transported/shipped.

Environmental protection



The packaging material can be recycled. Please do not place the packaging into the ordinary refuse for disposal, but arrange for the proper recycling.



Old appliances contain valuable materials that can be recycled. Please arrange for the proper recycling of old appliances. Batteries and accumulators contain substances that must not enter the environment. Please dispose of your old appliances, batteries and accumulators using appropriate collection systems.

Notes about the ingredients (REACH)

You will find current information about the ingredients at:

www.kaercher.com/REACH

Start up

Description of the Appliance

When unpacking the product, make sure that no accessories are missing and that none of the package contents have been damaged. If you detect any transport damages please contact your dealer.

Note: Please refer to page 2 for figures of the appliance and the operation.

Illustration 1

- 1 Charger with charging cable
- 2 **Basic appliance**
- 3 Charging box
- 4 Charge/operations display
- 5 Support leg
- 6 Handle
- 7 ON/OFF switch for appliance
- 8 Dirt water reservoir, removable
- 9 Lock, dirt water reservoir
- 10 **Suction head**
- 11 Release, suction head
- 12 Attachment with removable lips
- 13 Release, attachment
- 14 Spray bottle
- 15 Spray lever
- 16 Wiping attachment
- 17 Fixating ring
- 18 Micro-fibre wiping pad

19 Window cleaner concentrate

Assemble the appliance

Illustration 2

- Place the attachment on the suction head with the removable lips until you hear it lock in.

Attach the spray bottle and wiper attachment and fill it with detergent

Note: Please note that after first activation of the spray head the transport lock will be loosen.

Attach the wiping attachment

Illustration 3

- Remove the spray head from the spray bottle.
- Attach the wiper attachment to the spray head.
- Secure the wiper attachment and the spray head with the fixating ring.

Illustration 4

- Attach the wiper pad to the wiper attachment and secure with Velcro.

Fill the spray bottle

Illustration 5

- Fill the included concentrate (1 x 20 ml) into the spray bottle and fill the bottle slowly with clear water (makes 250 ml of detergent solution).
- Close the bottle.

Charge the battery

Illustration 6

- Insert the charger delivered with the appliance into a proper socket.
- Insert the charging cable plug to the back of the appliance.

Note: During the charging process, the charge/operating display blinks. Once the battery is fully charged, it will be permanently illuminated.

Recharge the battery after finishing your work.

Start working

Cleaning with spray bottle and wiper attachment*

Illustration **7**

- Press the spray lever on the bottle to apply the detergent and spray the surface evenly; after that, loosen the dirt using the wiping pad.

Note: Rinse pad under running water if needed!

Illustration **8**

- Switch the appliance on, the charge/operations display will illuminate.
- Pull the appliance from the top to the bottom to vacuum up the detergent.

Note: Hard to reach areas can be vacuumed vertically or horizontally (limited areas).

Notes:

If the battery is losing its performance, the charge/operations display will begin to blink slowly and the appliance will shut off after a certain time. In this case, recharge the battery.

Switch the appliance off after each cleaned surface. This will increase your operating time per battery charge.

Cleaning without the spray bottle

- Apply the detergent as usual according to manufacturer's instructions and loosen the dirt.
- Further procedure same as the "Cleaning with spray bottle and wiper attachment", see illustration **8**.

Interrupting the work

Illustration **9**

- Set the appliance on the support leg (parking position) and switch it off.

Emptying the reservoir during operation

Once the max. fill level (mark) of the dirt water reservoir is reached, please empty the tank.

- Turn off the appliance.

Illustration **10**

- Pull off the lock of the dirt water reservoir and empty the tank.
- Close the dirt water reservoir.

Finish up your work / clean appliance

- Turn off the appliance.

Illustration **11**

- First, release the attachment with the pull-off lips and remove it from the suction head, then release the suction head and remove.
- Clean the suction head and the attachment with the pull-off lips under running water (do not wash in dishwasher).

Illustration **12**

Caution: The basic appliance contains electrical components. Do not clean this under running water!

- Remove the dirt water reservoir, rotate the lock and pull out.
- Empty the reservoir and rinse with clear water. Close the reservoir again.
- Pull the wipe pad off the spray bottle and clean under running water. The wipe pad can be cleaned in a washing machine; however, do not use fabric softener.
- Let the cleaned appliance dry prior to assembly.
- Charge the battery.

Storing the Appliance

- Store the appliance upright in a dry room.

Troubleshooting

Spray bottle does not spray

- Refill detergent.
- Pump mechanism in spray bottle defective, contact dealer.

Machine does not start

Check the charge/operations display:

- No signal or slowly blinking signal: Charge the battery.
- With a rapidly blinking signal: Inform your dealer.

Streaks while cleaning

- Clean the pull-off lip.
- Turn the upper pull-off lip around by pulling it out to the side, turning it around and reinserting it.
- Replace pull-off lip if required.
- Adjust the dosing of cleaning solution.

Water is leaking from the air louvers

- Empty the dirt water reservoir (max. 100 ml content).

Special accessories

Window cleaner concentrate (4 x 20 ml)

Order No. 6.295-302.0

Micro-fibre wiping pad (2 piece)

Order No. 2.633-100.0

Pull-off lip (2 piece)

Order no.: 2.633-005.0

Specifications

Type of protection	IP X4	
Volume of dirt water reservoir	100	ml
Operating time with full charge	20	min
Nominal battery voltage	3,6	V
Rated power of appliance	12	W
Charging current for empty battery	2	h
Output voltage, charger	5,5	V
Output current, charger	600	mA
Sound pressure level (EN 60704-2-1)	54	dB(A)
Weight	0,7	kg
Battery type	Li-Ion	

Subject to technical modifications!

Disposal of Appliances

This appliance includes a built-in battery pack; please remove this battery pack before disposing of the old appliance.

Remove battery pack and dispose of

- The appliance may only be opened in order to dispose of the battery pack.

Caution when opening the appliance
avoid short circuits.

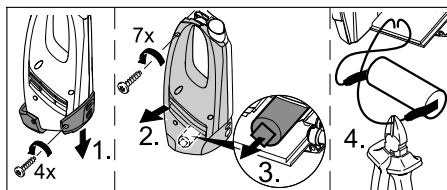

- Remove the battery pack and dispose of properly (at a collection site or the dealer).

⚠ Warning

- **Do not open the battery**, as there is a risk of an electrical short; also, irritating or caustic vapors can escape.
- **Do not expose the battery to direct sunlight, heat or fire**, there is a risk of explosion.

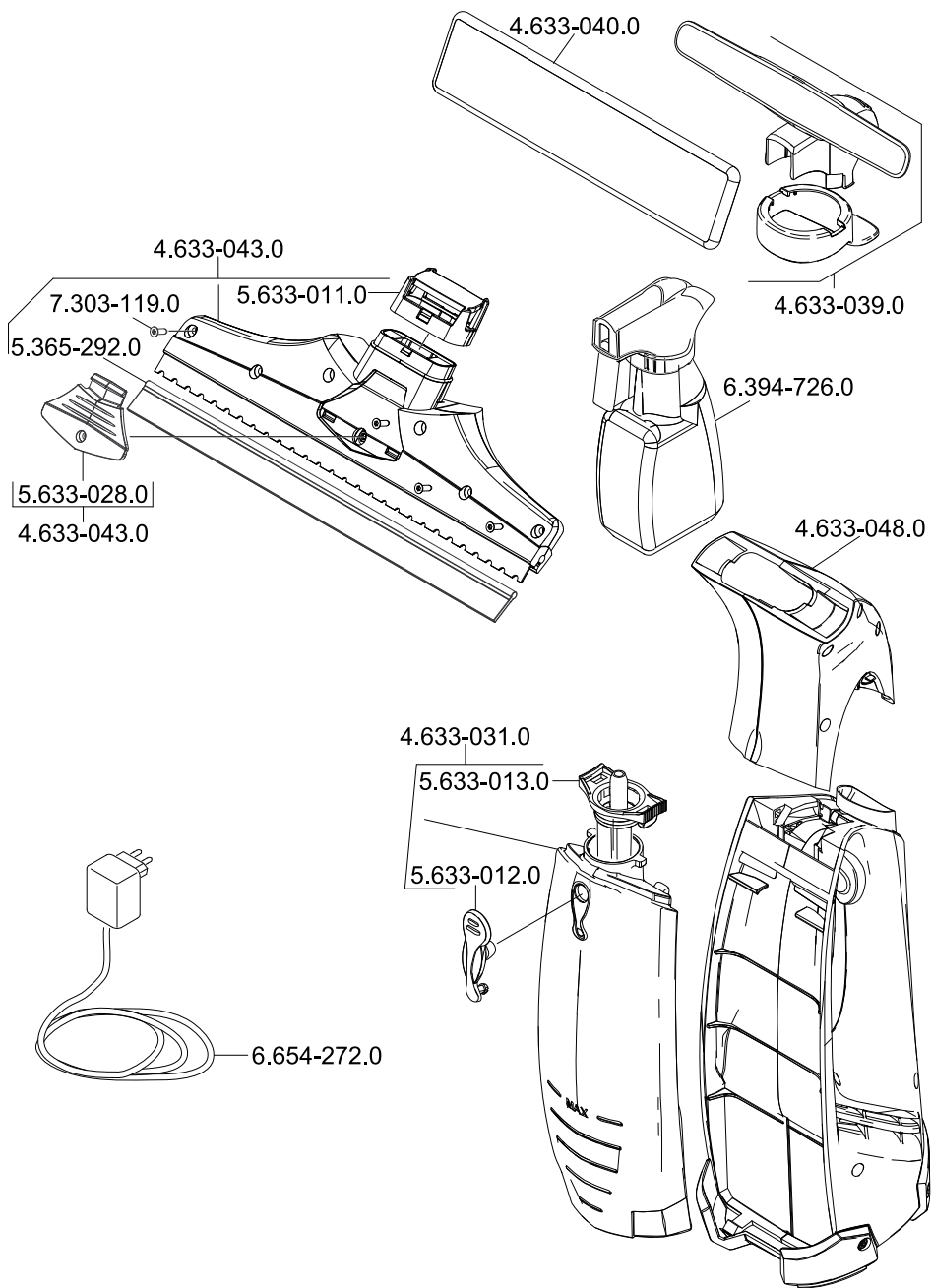

5.963-649.0 22.04.2010



www.karcher.com.au