

loven^hcare™

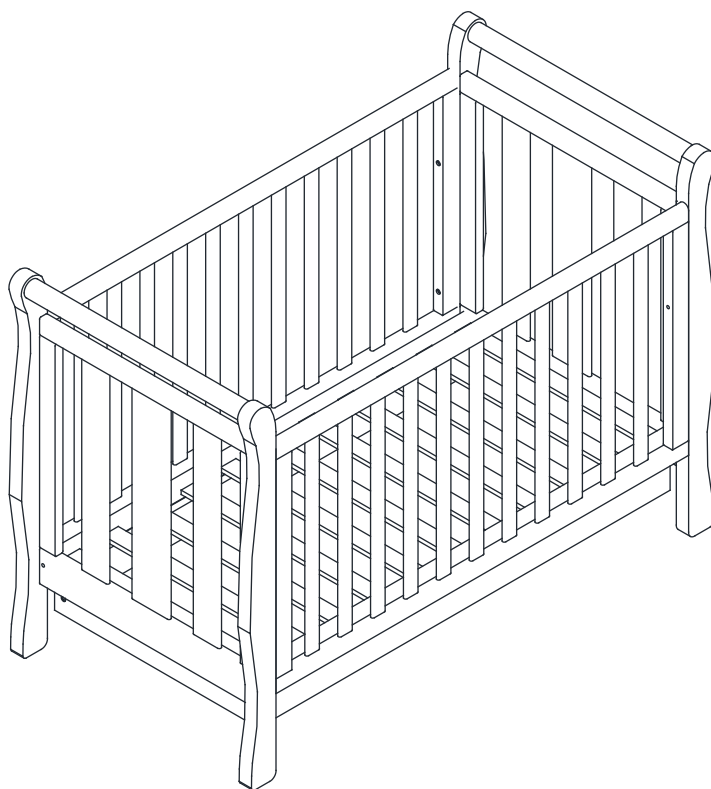

MIAMICOT

HK 100

PLEASE KEEP THESE INSTRUCTIONS FOR FUTURE REFERENCE

loveⁿcare™

Congratulations on your new quality Love N Care product from our exclusive range of baby products. This exceptional design combines the most unique features that any baby product offers.

We are confident that you will appreciate its many highlights, including its reliability and durability. Your new product has been manufactured to comply with the Highest Quality Standards and comes with a 12-month warranty.

As you will soon learn there are many more great features about your new Love N Care product.



love^hcare™

Safety guidelines and instructions must always be followed before making use of this product, please retain these instructions for future reference.

This product complies with product standard:

AS/NZS 2172:2003 Cots for household use - Safety Requirements

WARNING

This cot has been designed for a child up to 25kg

Do not leave your child unattended when the dropside is in the lower position

RECOMMENDED MATTRESS SIZE: This cot has been manufactured for use with a mattress which measure 690mm wide by 1300mm long and 130mm in thickness.

The width and length are specific because it is important that the gaps between the mattress and the sides and ends of the cot will not exceed 40mm. This is to minimize the risk of a child's limb becoming caught in the gap. The thickness of the mattress has been specified to ensure that the depth of the cot is greater than 500mm with the mattress base in the lower position to minimise the risk of a child climbing or falling out of the cot.







WARNING TO PREVENT FALLS, THE MATTRESS BASE OF THIS COT SHOULD BE ADJUSTED TO THE LOWEST POSITION BEFORE THE CHILD CAN SIT UP.

The manufacturer's assembly instructions must be followed in detail to ensure all the safety features of the cot are not compromised.

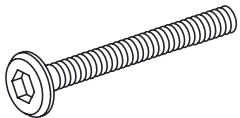
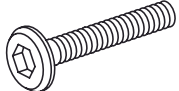
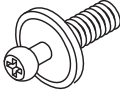
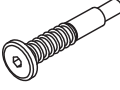
Please ensure that the cot is placed at a reasonable distance from curtains, blinds, heaters and power points.

Please keep medication, string, elastic, small toys or small items, such as money out of reach from any position in the cot.

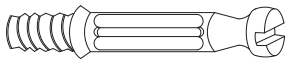
WARNING: TO PREVENT FALLS, THE MAXIMUM MATTRESS THICKNESS SHOULD NOT EXCEED 130mm.

PART#	SPECIFICATION	DRAWING	QTY
1	M6xL60mm		4
2	M6x45mm		4
3	Φ16*28mm		4
4	Φ15.8*51.5mm		2
5	M4*10mm		4
6	M4*20mm		4
7	Φ8*4*30mm		4
8	M6*40mm		8
9	Φ14.5*11.5mm		8
10	M4		2

PARTS LIST

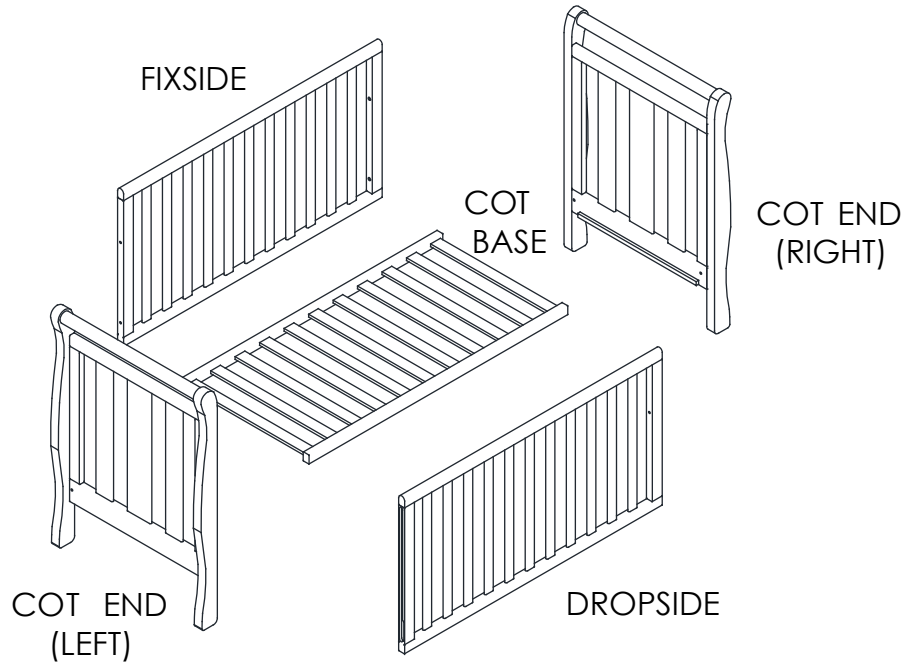



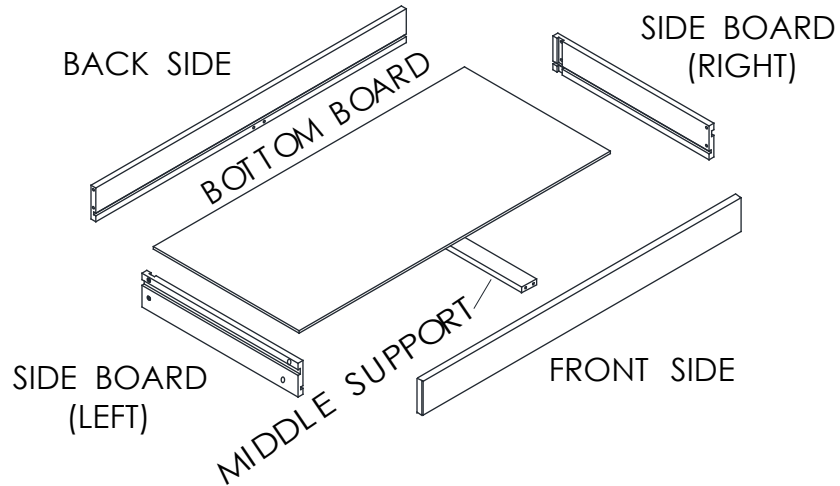

COT COMPONENTS



DRAWER COMPONENTS

ASSEMBLY

Attach the ends to the base

	4PCS
	4PCS
	4PCS
	4PCS
	

For newborn babies always place the base in the highest position until the child is able to sit up unassisted. Once the child is able to sit up unassisted use the lowest level. (as shown in FIG1)

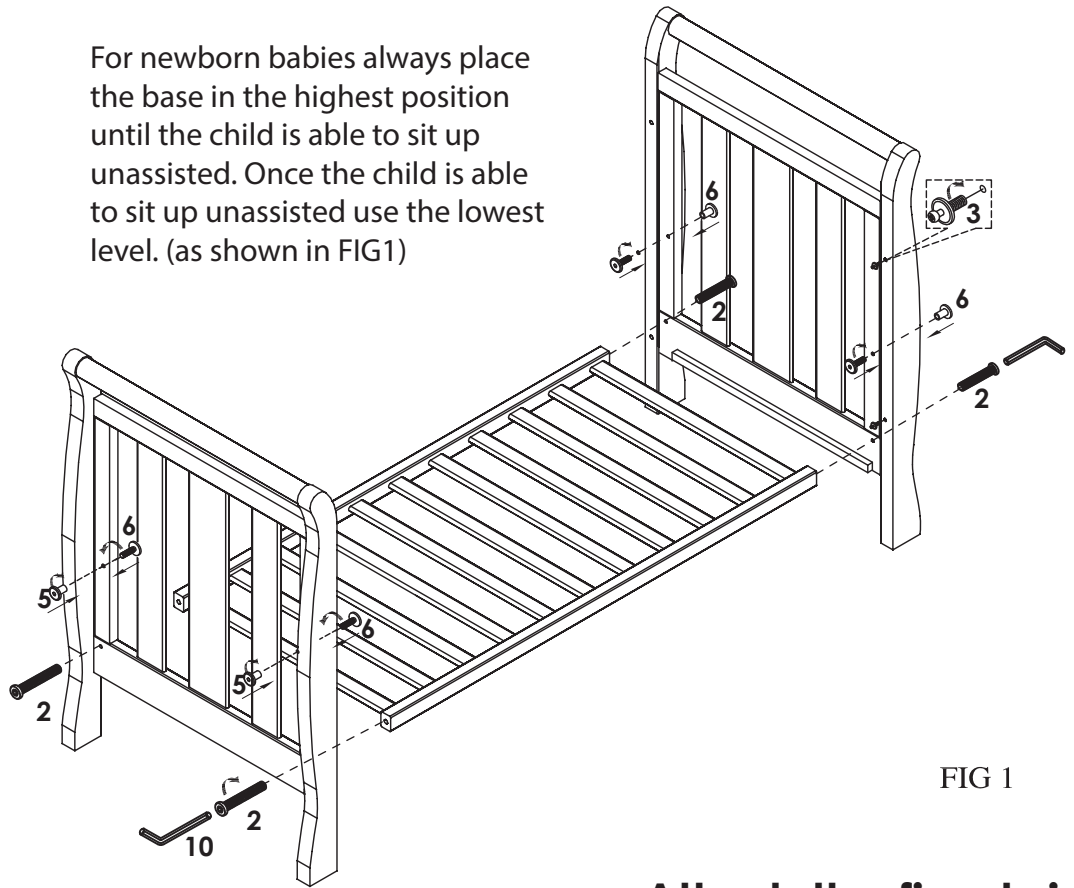



FIG 1

Attach the fixed side

	4PCS
	

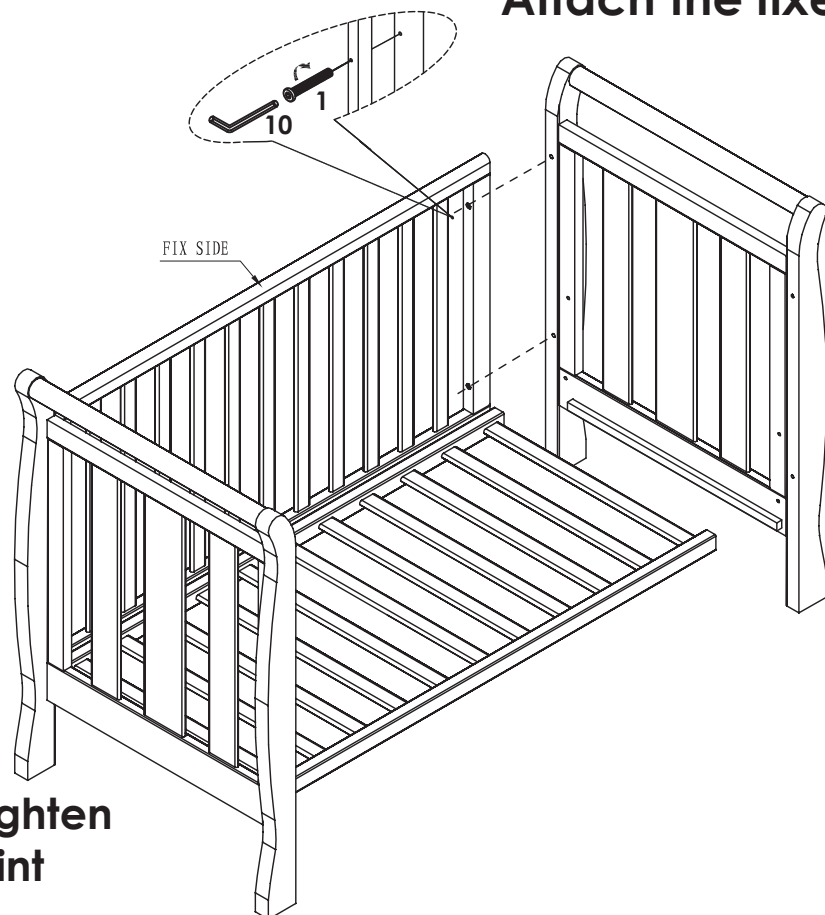
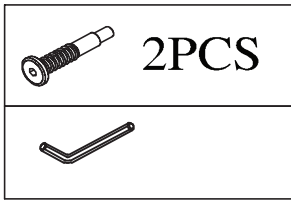

FIG 2

Please note: do not tighten completely at this point

ASSEMBLY



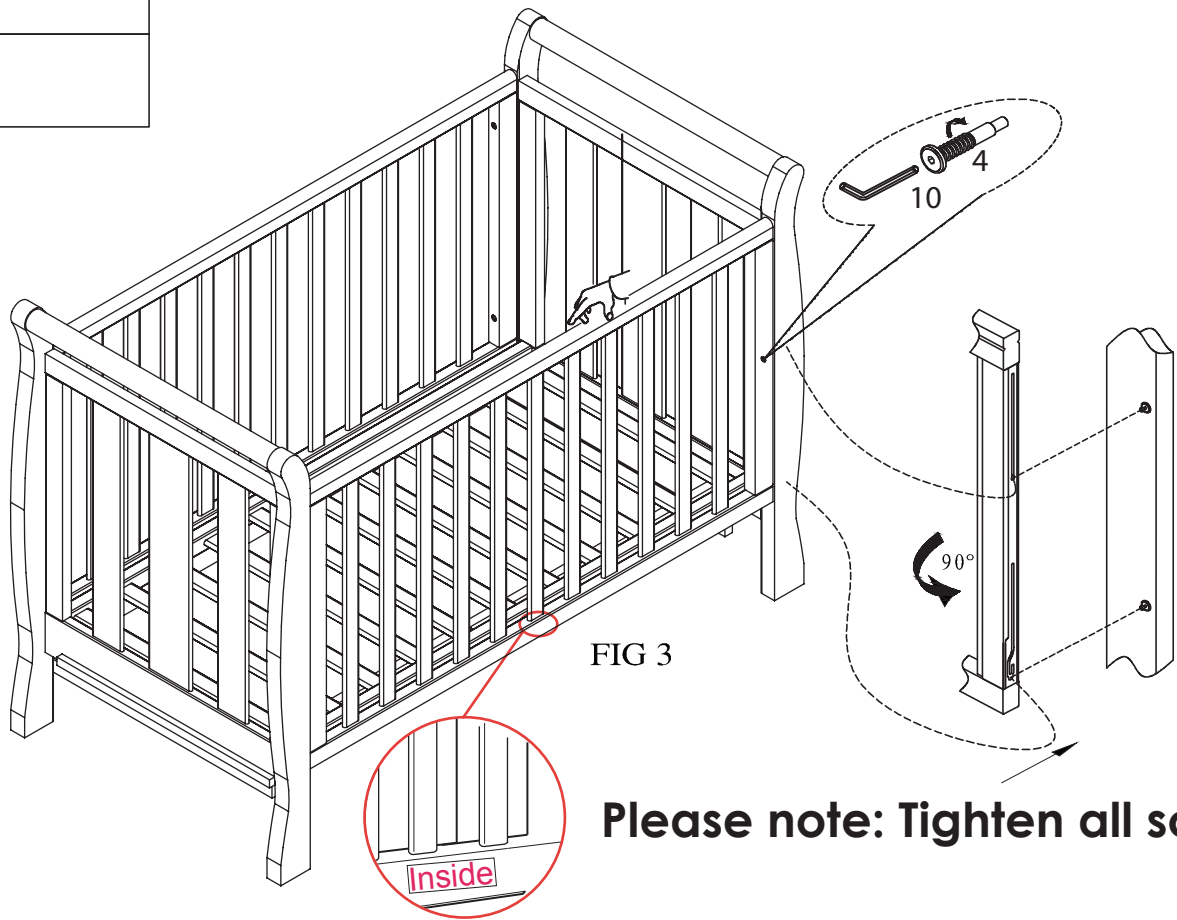

Attaching the drop side



ASSEMBLY

DRAWER ASSEMBLY

	6PCS
	6PCS

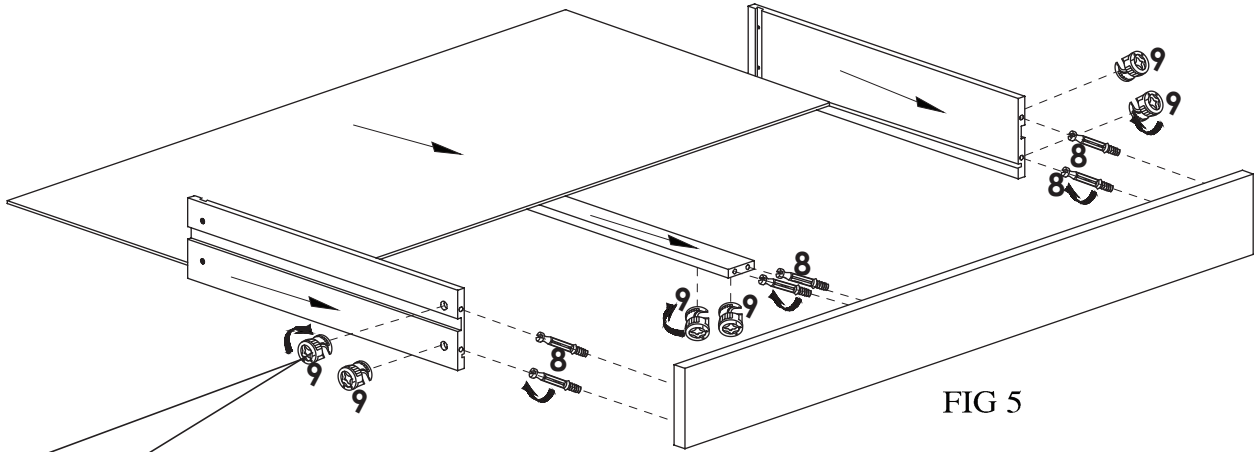
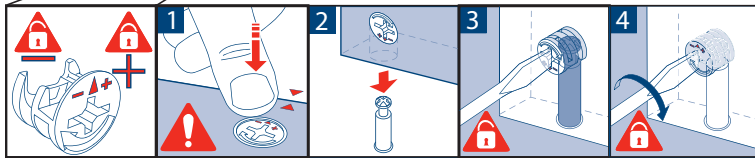





FIG 5



	4PCS
	2PCS
	2PCS

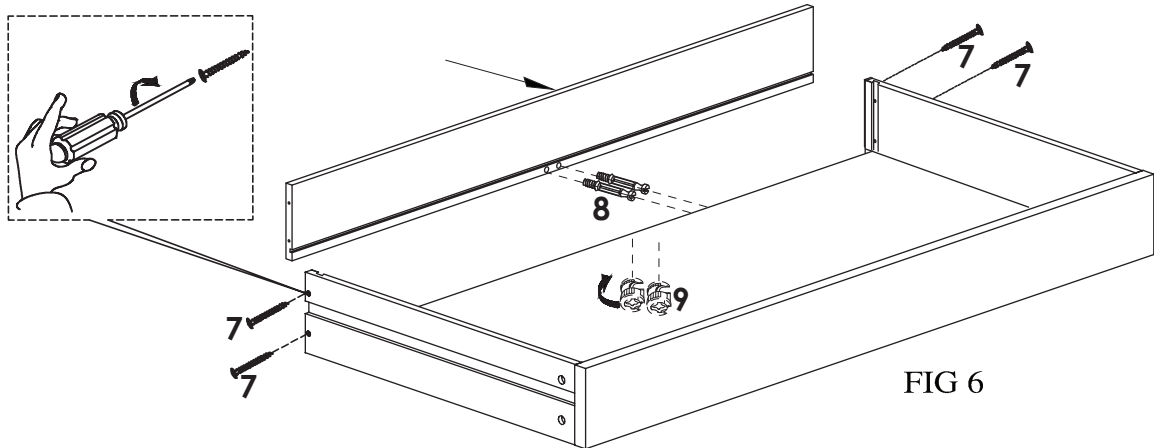

FIG 6

ASSEMBLY

Slide the drawer on the rails under the base

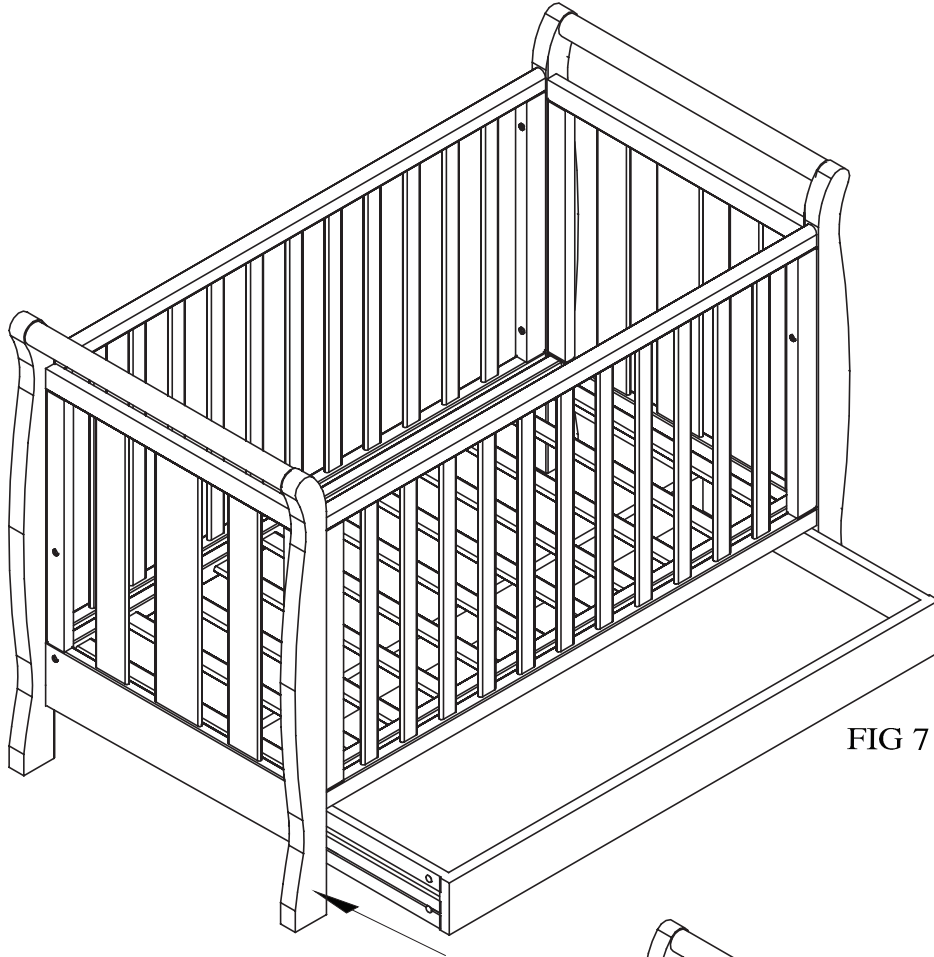

FIG 7

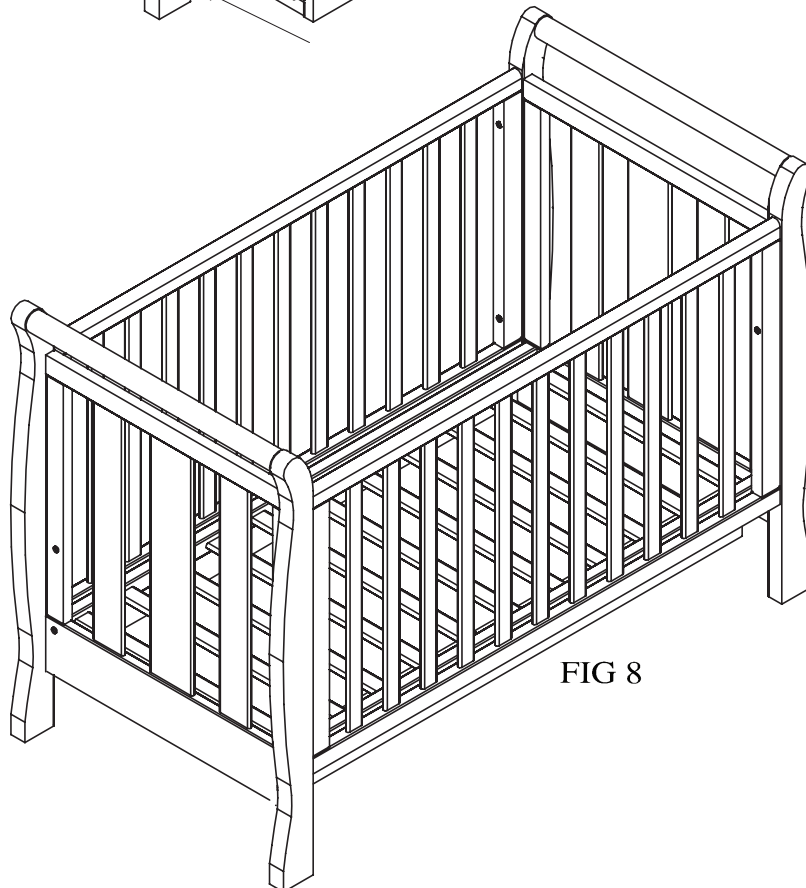

FIG 8

ASSEMBLY

CONVERTING COT TO LOUNGE (SOFA)

Remove the dropside from the cot leaving the fixed side attached.
Add the mattress and you can now use it as a Lounge (sofa)

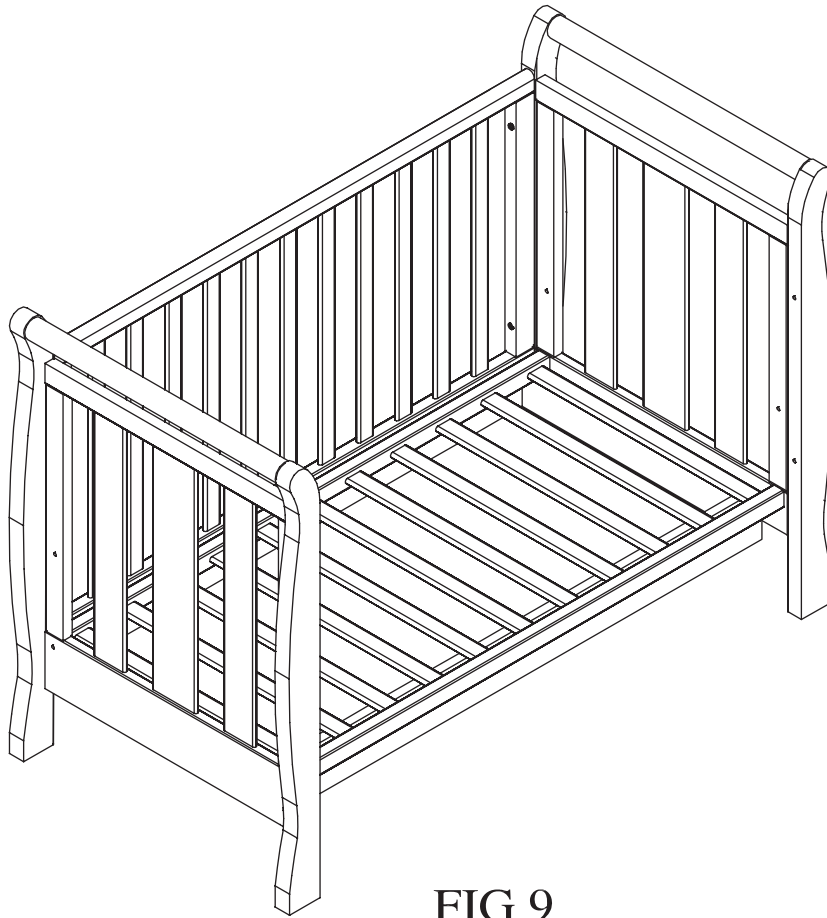

FIG 9



CARE AND MAINTENANCE

ALL LOVE N CARE PRODUCTS HAVE ONE YEAR WARRANTY FROM THE DATE OF PURCHASE.

IT IS RECOMMENDED TO REGULARLY INSPECT AND MAINTAIN MOVEMENT OF LOCKING DEVICES AND SECURITY OF ESSENTIAL COMPONENTS.

REGULARLY CHECK ALL PARTS FOR WEAR AND TEAR.

YOUR FURNITURE MAY BE CLEANED BY WIPING WITH A DAMP CLOTH AND DRYING WITH A SOFT CLEAN CLOTH. DO NOT USE ABRASIVES, BLEACH, ALCOHOL OR AMMONIA-BASED HOUSEHOLD POLISHES.

TAKE CARE WHEN HANDLING OR MOVING THE FURNITURE. CARELESS HANDLING MAY CAUSE DAMAGE.

CHECK THE COTS SCREWS AND LOCKS TO MAKE SURE THEY ARE ALL KEPT IN GOOD WORKING ORDER.

IF ANY OF THE PARTS ARE MISSING OR BROKEN YOU SHOULD CONTACT THE MANUFACTURER AND DISCONTINUE USING THE COT UNTIL THEY ARE REPLACED.

WARRANTY AGAINST DEFECTS.

All love n care products are guaranteed for twelve months from the date of purchase.

Our goods come with guarantees that cannot be excluded under the Australian consumer law. You are entitled to a replacement or refund for a major failure and for compensation for any other reasonably foreseeable loss or damage. You are also entitled to have the goods repaired or replaced

If the goods fail to be of acceptable quality and the failure does not amount to a major failure.

This covers against faults which develop through faulty materials and workmanship. Misuse, accidental damages, normal wear and tear or neglect are not covered.

If a fault becomes apparent, please return the item to the store of purchase with your receipt.

You must inform the store what the defect is. We will then arrange for its repair or it will be assessed for replacement as expediently as possible. The benefits of this warranty are in addition to other rights and remedies under the law in relation to the goods and services to which this warranty relates.

If you are unable to return the item to the store of purchase, you can contact love n care on freecall 1300732599. We will then organise for either somebody to inspect the item or arrange for a courier to pick it up and return it back to you.

For more information please contact:



Love N Care Pty Ltd

Email: info@lovencare.com.au

Web: www.lovencare.com.au

Phone: 1300 732 599

Fax: 02 9774 4633



Contact Us

Head Office:

Love N Care Pty Ltd.

297-299 Canterbury Rd, Revesby

NSW 2212 Australia

Contact No: 02 9774 4655

Fax: 02 9774 4633

Email: info@lovencare.com.au

Website: www.lovencare.com.au

let's be friends!

 <http://www.facebook.com/lovencare1>

 http://twitter.com/love_ncare



100% AUSTRALIAN OWNED SINCE 1984

lovehncare™
lovencare.com.au