

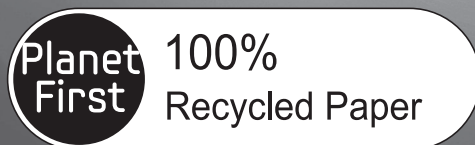

WA65F5S2  
WA70F5S2

# Washing Machine user manual



**This manual is made with 100% recycled paper.**

imagine the possibilities

Thank you for purchasing a Samsung product.

To receive a more complete service, please register your product at

[www.samsung.com/register](http://www.samsung.com/register)



DC68-03273G-02



# contents

---

<b>SETTING UP YOUR WASHER</b>	<b>7</b>	Description of part
	<b>10</b>	How to wash automatically depends on the laundry
	<b>11</b>	Control Panel

<b>MANUAL FUNCTIONS</b>	<b>13</b>	Manual functions
-------------------------	-----------	------------------

<b>INSTALLATION &amp; MAINTENANCE</b>	<b>14</b>	Environment
	<b>14</b>	Leveling
	<b>14</b>	Connecting the water supply hose
	<b>15</b>	Assembling the rat protection panel (option)
	<b>16</b>	How to connect the drain hose (option)
	<b>17</b>	Adding detergent
	<b>17</b>	Adding fabric softener
	<b>18</b>	Water supply connector filter
	<b>18</b>	Cleaning the filter
	<b>18</b>	Cleaning the pump filter (option)
	<b>18</b>	Cleaning the detergent compartment

<b>TROUBLESHOOTING</b>	<b>19</b>	Troubleshooting
------------------------	-----------	-----------------

<b>WASHING MACHINE WON'T WORK?</b>	<b>20</b>	Washing machine won't work?
------------------------------------	-----------	-----------------------------

<b>SPECIFICATION</b>	<b>22</b>	Specification
----------------------	-----------	---------------

# safety instructions

---

Please note that the following precautions for safety intend to prevent unpredictable danger and damage by helping the proper use in safety.

When using hot water in washing, please make sure that the water should not exceed 50°C.

- Plastic parts may be deformed or damaged, and an electric shock or a fire may take place.

## IMPORTANT SAFETY PRECAUTIONS

---

**⚠ WARNING: To reduce the risk of fire, electric shock, or injury to persons when using your appliance, follow basic precautions, including the following:**

Do not let children (or pets) play in or on your washing machine. The washing machine door does not open easily from the inside and children may be seriously injured if trapped inside.

This appliance is not to be used by persons (including children) with reduced physical, sensory or mental capabilities, or lack of experience and knowledge, unless they have been given supervision or instruction concerning use of the appliance by a person responsible for their safety.

Children should be supervised to ensure that they do not play with the appliance.

**For use in Europe:** This appliance can be used by children aged from 8 years and above and persons with reduced physical, sensory or mental capabilities or lack of experience and knowledge if they have been given supervision or instruction concerning use of the appliance in a safe way and understand the hazards involved. Children shall not play with the appliance. Cleaning and user maintenance shall not be made by children without supervision.

If the supply cord is damaged, it must be replaced by the manufacturer, its service agent or similarly qualified persons in order to avoid a hazard.

# safety instructions

---

This appliance should be positioned so that the power plug, the water supply taps, and the drain pipes are accessible.

for appliances with ventilation openings in the base, that a carpet must not obstruct the openings.

The new hose-sets supplied with the appliance are to be used and that old hose-sets should not be reused.

**CAUTION:** In order to avoid a hazard due to inadvertent resetting of the thermal cut-out, this appliance must not be supplied through an external switching device, such as a timer, or connected to a circuit that is regularly switched on and off by the utility.

## WARNING

---

There might be serious injury or fatal accident when you violate this instruction.

- Do not pull the cord off or touch it with moist hands.
  - An electric shock or a fire may take place.
- Do not bend the power supply cord by force or press it with heavy things.
  - An electric shock or a fire may take place.
- Do not install the washer nearby electric implement or don't put a candle light or cigarette light on the washer.
  - A fire may take place.
- During operation, do not put your hands or metal materials under the washer.
  - You may be hurt by spinning board beneath the washer.
- Stay away from the washer when the bottom of the washer sinks into the water.
  - There might be an electric shock. Please wait until the water drains out completely.
- Do not put laundry stained with gasoline, benzene, or alcohol in the washer, and keep the materials away from the washer.
  - An explosion or a fire may take place.
- During spinning, don't put your hand in the spinning tub.
  - It may hurt your hands. If it does not stop within 15 seconds after you open the lid, call service agent immediately.
- This appliance has to be connected to the plug endurable to proper power consumption.
- This appliance has to be positioned so that the plug is accessible after installation.
- No user-serviceable parts inside. Refer any servicing to qualified service personnel.
  - Otherwise this may cause a mechanical error, electric shock, fire or physical damage.
  - The product warranty does not cover problems resulting from disassembling the product.
- Do not use this product for business purposes.

# safety instructions

---

## CAUTIONS

---

There might be a slight injury or damage when you violate this instruction.

- Don't install it in the area with moisture or outdoor where it has rain or snow.
  - An electric shock or a fire may take place.
- Please unplug the power supply cord when you do not use it.
  - An electric shock or a fire may take place.
- If there is dust or water on the power supply plug and its connected part, please remove it completely.
  - An electric shock or a fire may take place.
- Do not make your kids look into the inside of the washer.
  - If your kid falls into the washer, his life could be in danger.
- Ventilate immediately without touching the power plug if gas is leaking.
  - An electric shock or a fire may take place if it catches flame.
- If the washer makes strange noise, smell or smoke, unplug it promptly and call service agent.
  - An electric shock or a fire may take place.
- When cleaning, don't spray water to the parts of the washer directly.
  - It may make its life span shorten.Also an electric shock or fire may take place.
- Do not use the strong acid cleaning agent.
- Don't use several appliances together with an outlet.
  - A fire may take place due to unusual heat.
- Don't press the button with an awl or pin.
  - An electric shock or a fire may take place.
- If the damage is found on the current cord in use, it should be replaced by manufacturer, service center or authorized person in order to avoid the risk.
- Connect the grounding wire to the shell plate, and bury it under at least 25cm of earth:alternatively, connect the ground wire to the appropriate pin on a properly grounded power receptacle. Never connect the wire to a telephone line, lightning rod, or gas pipe. **option**
- The product you have purchased is designed for domestic use only.  
The use for business purposes qualifies as product misuse. In this case, the product will not be covered by the standard warranty provided by Samsung and no responsibility can be attributed to Samsung for malfunctions or damages resulting from such misuse.

# setting up your washer

## DESCRIPTION OF PART

The User's Manual is for common use.

Make use of the User's Manual depending upon your washing machine model.

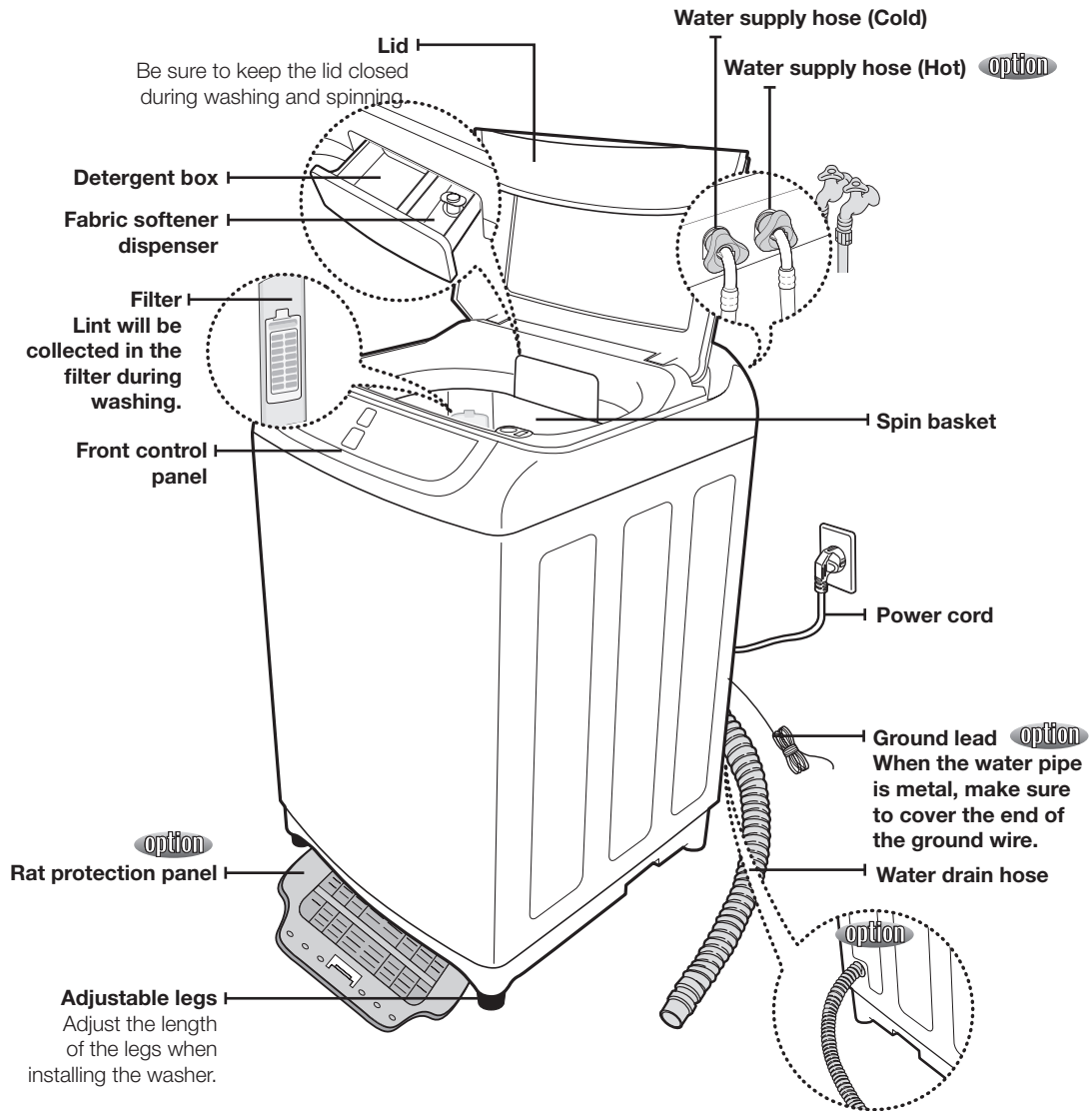

# setting up your washer

## CHECKING BEFORE WASHING AND CARING FOR GARMENTS

Must follow the checkpoints in order to avoid machine problems or damages on garments.

- If the below problems are caused by customer's faults, separate service fee will be charged.

### Checkpoints Before Starting Washing

Check if the clothes are bleaching or not.

- Add liquid detergent to a white towel and the garment where you can't notice well. Then, rub together strongly. Check if the color transferred to the towel.
- Be careful for scarves and imported clothes since they are easily discoloring.
- Check for stains or partial dirt.
- If stains are found, use the towel wet with detergents to rub on in a single direction.
- Before washing, the sleeves, collar, dress hem and pockets are pre-treated by brushing with detergents.

The wrinkle-processed clothes made of wool are specially treated by fixing them with threads before washing. The threads shall be removed after the clothes are dried.

### Not washable laundry

Clothes those are easily transformable even by soaking in water.

- Even by soaking in water, neckties, brassieres, jackets, suits and coats can be easily transformed like shrinking and discoloring on the garment surfaces because they are mostly made of rayon, polynosic, cuff and their blend fabrics.
- The wrinkle-processed, embossed, or resin processed products are easy to transform even by soaking in water.
- Easily discoloring products made of cotton and wool, wrinkled silk, leather products, leather accessory, leather ornamented clothes and its accessory.
- Don't wash those clothes without handling guideline or material indication tag.

### About Detergent

- When detergents are not dissolving well, use warm water (about 40°C) to dissolve the detergent.



- Use an appropriate amount.
- Even if excess amount of detergent is used, there is not much difference in washing result. It may cause damages to the garments because rinsing is not enough.
- The bleaching agent may cause damages to garments since it is strong alkali.
- Do sufficient rinsing because the powder detergent is easily remained on the garments causing bad odors.
- If too much detergent is used or cold water is used, it doesn't dissolve completely and remain on the garments, hose or spin basket, causing contamination on clothes.
- In case of reserved washing, detergents must be put in the detergent box. If the powder detergents are spread on laundry directly, it may cause discoloration.



## CARING FOR CLOTHES BEFORE WASHING

### Take out personal belongings from pockets.

- Caution, Check the pockets! Hairpins and coins cause damages to clothes and washing machine. They make noise and problems to the machine. Must check the pocket.



### If pants zippers are open while washing, the spin basket may be damaged. The zipper should be closed and fixed with a string before washing.

- Metal on the clothing may cause damage to the clothes and the tub.
- Turn clothing with buttons and embroidered clothes inside out before washing them.
- Clothing with long strings may become entangled with other clothes, and may cause damage to the clothing. Be sure to fix the strings before washing.

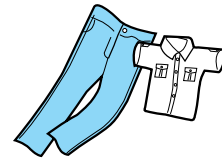

### Waterproof clothes (Ski Wear, Diaper Covers, Footboards) are not allowed for washing.

- This may cause the laundry to be ejected or cause the washing machine to vibrate abnormally, which may result in personal injury or damage the washing machine, the floor or the clothing. (Diapers, waterproof clothing, raincoats, umbrella covers, skiwear, car cover sheets, and sleeping bags, etc.).
- When the tub rotates, water may become trapped in the waterproof clothing or fabric and can collect in a corner, causing abnormal vibrations. In addition, the laundry rises and may be ejected and cause personal injury.

### Shake the dirt or soils from clothes.

- Soil and sands may rub delicate garments to cause damages and the washing result may be unsatisfactory.

### Do pre-washing for white socks, sleeves, and collars before the main washing.

- For stains and dirt on collars, sleeves, hems, and pockets, apply some detergent to them and apply it lightly with a brush before washing.
- Use powdered or liquid detergent. Do not use soap as the tub may become dirty from the dirt on it.

### Turn inside out for those nappy clothes before washing.

- If clothes have too much foreign matter, separate them for washing. Other clothes may pick up those dirty matters (dirt, thread).
- Wash black colored clothes and cotton towels separately. If they are washed together, towels may pick up dirty matters. Check before washing.

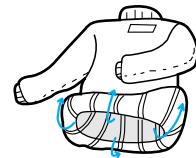

### Cashmilon and those garments having big volume and lightweight (eg. Lase-decorated clothes, lingerie, nylon stocking, synthetic fabrics etc.) may rise and cause damages to the clothes and problems to the machine. Use the laundry net or wash them separately.

- Must put those long stringed clothes, lase-worked clothes, bed cover sheet, wool clothes into a laundry net before washing.
- Put delicate clothes in the laundry net.
- Use only those commercial laundry net for washing.

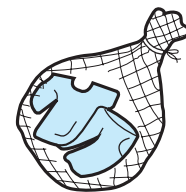

### Curtains, floating garments or blue jeans shall be pressed not to float on the water.

- If they are floated on the water, press Start/Pause button to stop and press them to sock in the water. If the washing goes on with clothes floating on the water, it may cause damages to the clothes and the washing machine as well as unsatisfactory washing result.

# setting up your washer

## HOW TO WASH AUTOMATICALLY DEPENDS ON THE LAUNDRY

### Before starting washing, check the following;

- Connect the water supply hose to the water tap. Leave a tap open. Plug the power cord in. Make sure to lay down the drain hose.

### Washing for the first time

Before washing clothes for the first time, you must run a complete cycle without clothes.

To do this:

1. Press the **Power** button.
2. Open the detergent drawer and insert a little detergent.
3. Turn on the water supply to the washing machine.
4. Press the **Start/Pause** button.  
This will remove any water from the manufacturer's test run remaining in the machine.

### Special notes!

#### Automatic Sensing Function

- According to the selected program, the amount of laundry is automatically sensed and then the appropriate water level, wash time, rinse cycle, and spinning time are automatically selected for the automatic wash.
- After the power is on, a program is selected and **Start/Pause** button is pressed. Then, the washing board starts spinning without water. This action senses how much laundry is in the washing basket, not a machine problem. After this sensing process, water supplies automatically.

#### Adding Detergent and Softener

- It senses the amount of laundry and indicates the water level and amount of detergent. Then, it starts water supply right away.
- During the water supply, it is possible to open the detergent box and add detergent. However, it is better to press **Start/Pause** button to stop water supply and add detergent. Close the lid and press **Start/Pause** button again. This way is much more convenient.
- If the softener is inserted in the softener dispenser, it automatically adds in at the last rinsing cycle.

#### Put the laundry into the washer and add detergent, too.

- Be careful not to overload. Use right detergent for the fabrics you are washing.
-  • If the lid is open while running, the washing machine is stopped automatically for safety. (Except, water supply continues while the lid is open.)
- When hot water is selected, both cold and hot water are supplied for the first 20 seconds in order to protect the clothes.
- Possible to control the washing time, rinsing cycle, and spinning time at every program during the washing.

## CONTROL PANEL

For more details, see control panel of your washing machine.

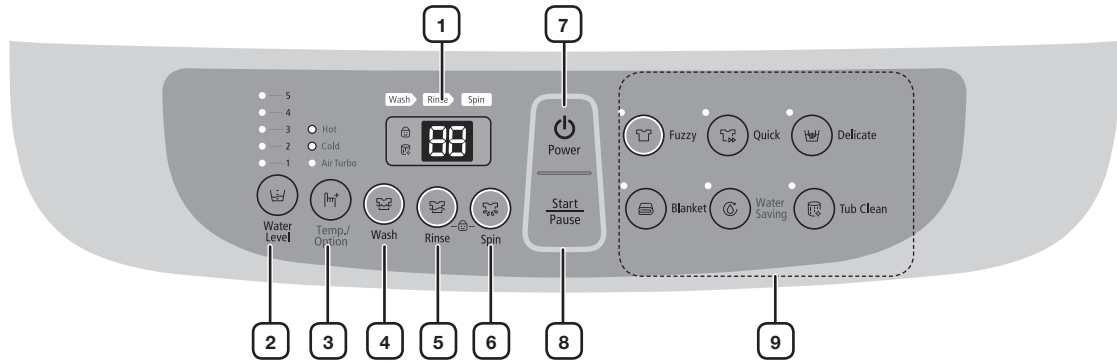

<b>1</b>	<b>Digital graphic display</b>	Displays the remaining wash time. Displays the error state if a problem occurs in the washing machine so that you can take action.
<b>2</b>	<b>Water Level</b>	The water level is automatically adjusted. However, you can select the water level manually by pressing this button.
<b>3</b>	<b>Temp./Option</b>	Press this button repeatedly to cycle through the water temperature and Air Turbo option: Cold > Cold, Air Turbo > Cold/Hot > Cold/Hot, Air Turbo > Hot > Hot, Air Turbo
<b>4</b>	<b>Wash</b>	Press this button to perform a wash only or to adjust the washing time. You can set the wash time from between 6 to 30 minutes.
<b>5</b>	<b>Rinse</b>	Press this button to perform a rinse only or to adjust the rinse count. You can set the rinse count up to five times.
<b>6</b>	<b>Spin</b>	Press this button to perform a spin cycle only or to adjust the spin time. You can set the spin time from between 1 to 9 minutes. When only a spin is selected, the spin time will be different from the total remaining time. This is because the total remaining time includes the actual spin time and the times for water draining and stopping.
<b>7</b>	<b>Power</b>	Press this button once to operate. Press it again to turn the power off.
<b>8</b>	<b>Start/Pause</b>	Use to pause and restart the operation. To change the washing procedure during an operation, press this button to stop, and again to restart after changing the procedure.

# setting up your washer

<b>9</b> Cycle	<b>Fuzzy</b>	Selects the best washing program automatically.
	<b>Quick</b>	If you want to wash those frequently used towels or less dirty laundry time. Because washing is speedy, it is good for light or less stained laundry.
	<b>Delicate</b>	Washable sweater, cardigan, delicate clothes etc.
	<b>Blanket</b>	Big volume laundry like blanket and bed cover sheets
	<b>Water saving</b>	This program reduces water consumption. Water Saving, Hot & Cold, Water Level 5 program is suitable for a normally soiled cotton load. Energy and water labelling test programme in accordance with AS/NZS 2040.
	<b>Tub Clean</b> 	Use this program to clean the tub, it will keep the tub clean and sanitary. The TUB CHECK LED is turned on to notify the user that it is time to clean the tub. The powerful spinning force of the washing tub pulsator removes the contaminations from the exterior of the washing tub to prevent odors or secondary contamination.

## CHILD LOCK

This function is for protecting children, the elderly and the frail.

1. Press the **Power** button.
2. To activate the Child Lock function, press and hold both the **Rinse** and **Spin** buttons down simultaneously for 3 seconds. (If the Child Lock function is activated, the Child Lock icon blinks.)
3. Operations after activating the Child Lock function.
  - Even if the Child Lock function is activated, every button works until the door opens.
  - When you open the door during the Child Lock is being activated, the alarm sounds and an error message appears. In 30 seconds, draining begins automatically. However, if you close the door within 30 seconds, water will not be drained. (Displayed error message "CL", "dE").
  - To add laundry after activating the Child Lock function, you must deactivate the Child Lock function.
4. To deactivate the Child Lock function, press and hold both the **Rinse** and **Spin** buttons simultaneously for 3 seconds again. (If the Child Lock function is deactivated, the Child Lock icon is turned off.)
5. To clear "CL" display, after draining is complete, close the door of the washing turn the power off and then on.



- This function is for preventing injury and malfunction of the product because of inappropriate operations or actions by children, the elderly or the frail.
- If the door opens when the Child Lock function is activated, the water is drained by force to prevent children from drowning.
- To add laundry after activating the Child Lock function, you must deactivate the Child Lock.
- Even if the power is turned off and then on when the Child Lock is activated, the Child Lock remains activated.





- Once Child Lock is activated, even when the power is turned off, if the door is opened, water is automatically drained in 30 seconds.
- The Child Lock function cannot be deactivated when CL is displayed. (However, the Child Lock function can be deactivated when the dE error is displayed.)

# manual functions

Possible to select the function for each program.

(Example) For a simple washing as the little dirt program :

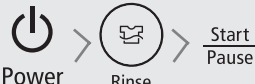
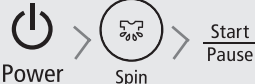
Power → Select the little dirt program → Wash → Start/Pause

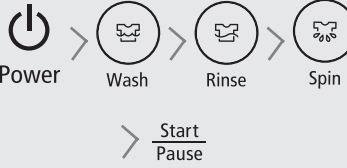
<p><b>WASH ONLY</b></p>  <p>Power &gt; Wash &gt; Start/Pause</p>	<p>Press the <b>Power</b> button.            Press the <b>Wash</b> button.            Press the <b>Start/Pause</b> button.            Washing goes on for 1 time.            When the <b>Wash</b> button is pressed during washing, the wash time can be changed to between 6 and 30 minutes in duration.</p>
<p><b>RINSE ONLY</b></p>  <p>Power &gt; Rinse &gt; Start/Pause</p>	<p>Press the <b>Rinse</b> button.            Press the <b>Start/Pause</b> button.            Rinsing goes on for 1 time.            When the <b>Rinse</b> button is pressed, the rinse times can be changed to between 1 to 5 times in duration.</p>
<p><b>SPIN ONLY</b></p>  <p>Power &gt; Spin &gt; Start/Pause</p>	<p>Press the <b>Spin</b> button.            Press the <b>Start/Pause</b> button.            Spin drying goes on for 4 minutes.            When the <b>Spin</b> button is pressed, the spin time can be changed to from 1 to 9 minutes.</p>
<p><b>WASH AND RINSE</b></p>  <p>Power &gt; Wash &gt; Rinse &gt; Start/Pause</p>	<p>Press the <b>Wash</b> and <b>Rinse</b> button.            Press the <b>Start/Pause</b> button once.            Detects the amount of laundry, and determines wash and rinse time period automatically. (Option)            When the <b>Wash</b> and <b>Rinse</b> button is pressed, wash time period is determined between 6 to 30 minutes, and rinse time is determined between 1 and 5 times.</p>
<p><b>RINSE AND SPIN</b></p>  <p>Power &gt; Rinse &gt; Spin &gt; Start/Pause</p>	<p>Press the <b>Rinse</b> and <b>Spin</b> button.            Press the <b>Start/Pause</b> button once.            Rinsing and spin drying follow.            When the <b>Rinse</b> and <b>Spin</b> button is pressed, the number of rinse times is determined between 1 and 5, and spin time period for drying is determined between 1 to 9 minutes.</p>
<p><b>WASH, RINSE AND SPIN</b></p>  <p>Power &gt; Wash &gt; Rinse &gt; Spin &gt; Start/Pause</p>	<p>Press the <b>Wash</b>, <b>Rinse</b> and <b>Spin</b> button.            Press the <b>Start/Pause</b> button once.  <b>Wash</b>, <b>Rinse</b> and <b>Spin</b> is performed.</p>

# installation & maintenance

The User's Manual is for common use.

Make use of the User's Manual depending upon your washing machine model.

## ENVIRONMENT

### Leave some space

Maintain at least 10 cm between the washer and the wall.

### Place the washer on a sturdy flat surface.

If the washer is placed on an uneven or weak surface, noise or vibration occurs. (Allowable is 1°)

### Adjust the legs for even placement.

### Never install the washer near water.

Do not place the washer in steamy rooms or where the washer is directly exposed to rain. Moisture may destroy the electrical insulation causing an electrical shock hazard.

### Avoid direct sunlight or heaters.

As plastic and electrical components are affected by direct heat, never place the washer near furnaces, boilers, etc. Do not place under direct sunlight.

## LEVELING

- If the washer is not leveled with the ground, it makes the machine tremble more or be out of order. So, make sure that the washer is leveled properly.

### SEE IF THE MACHINE IS PLACED LEVEL BY CHECKING THE POSITION OF THE WASHING TUB.

- Open the lid of the machine, pour water into the tub up to the level just below the pulsator, and adjust the legs so that the pulsator is positioned at the center of the water as shown in the figure.
- Place the machine more than 10 cm away from the wall.
- Adjust the legs on feet for leveling.

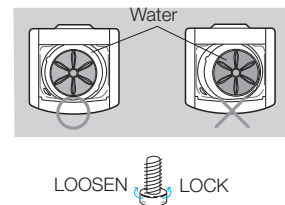

## CONNECTING THE WATER SUPPLY HOSE

1. Remove the adaptor from the water supply hose.



2. First, using a "+" type screw driver, loosen the four screws on the adaptor. Next, take the adaptor and turn part (b) following the arrow for gap about 5 mm between them.

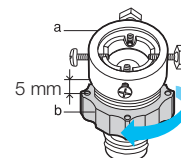

3. Connect adaptor to the water tap by tightening the screws firmly. Then, turn part (b) following the arrow and put (a) and (b) together.

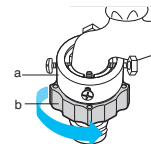

4. Connect the water supply hose to the adaptor. Pull down the part (c) of the water supply hose. When the part (c) is released, the hose is automatically connected to the adaptor making a 'click' sound.

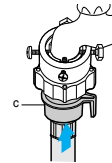

5. Connect the other end of the water supply hose to the inlet water valve at the back of the washer. Screw the hose clockwise all the way in.

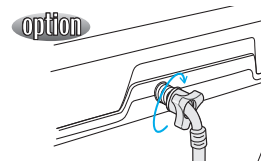

- 5-1. Connect the other end of the water supply hose to the inlet water valve at the back side of the washer. Screw the hose clockwise all the way in.

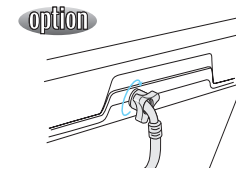

- If the water tap is a screw type, assemble a water supply hose that fits to the tap as shown. After completing connection, if water leaks from the hose, then repeat the same steps.

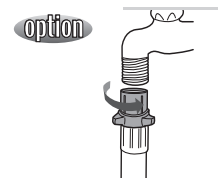

-  After completing connection, if water leaks from the hose, then repeat the same steps. Use the most conventional type of faucet for water supply. In case the faucet is square or too big, remove the spacing ring before inserting the faucet into the adaptor.

## ASSEMBLING THE RAT PROTECTION PANEL (OPTION)

Tilt the washer a little and lift up the panel until it clicks as shown in the figure.

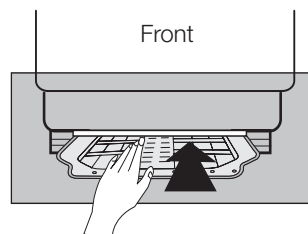

1. Insert the rat protection panel to the assembling hole on front side to the end.

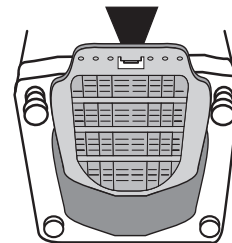

2. If you have difficulty inserting the panel lift up the washer a little and insert it.

# installation & maintenance

## HOW TO CONNECT THE DRAIN HOSE (OPTION)

### IN CASE OF PUMP-DRAINED WASHER

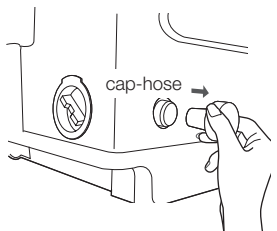
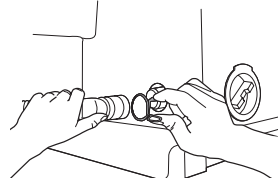
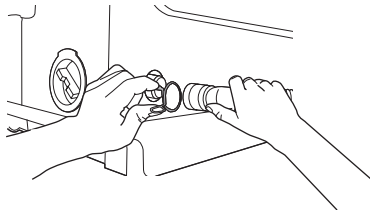
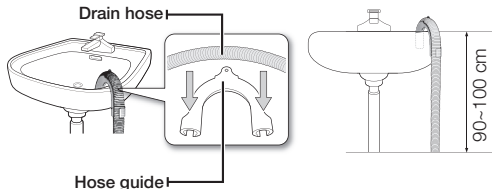
 <p>cap-hose →</p> <p>Take out the cap-hose and connect the outlet-hose. (option)</p>	 <p>Be sure to join tightly the drain hose into the drain outlet on the back of the machine.</p>
 <p>Be sure to join tightly the drain hose into the drain outlet on the side of the machine.</p>	 <p>Drain hose</p> <p>Hose guide</p> <p>90~100 cm</p> <p>Install the drain hose in the position of about 90~100 cm above the ground. The end of the drain hose can not be sinked under water.</p>

### IN CASE OF GENERAL WASHER (OPTION)

1. After pressing the joint ring, insert to the drain hose.

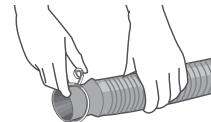

2. After directing the drain hose to a drain, join to the drain outlet of the washing machine.

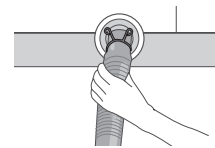

drain-outlet

3. Be sure to join them tightly by pressing the joint ring and pushing it into the drain-outlet.

- The length of drain hose is adjustable so that you can extend the length appropriately.

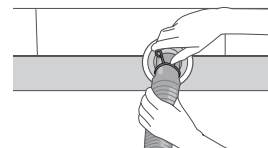

### HOW TO CHANGE THE DRAIN HOSE DIRECTION (OPTION)

- The handle of joint ring is pressed to pull out the drain hose. Change the direction of the drain hose and follow the above guideline again.

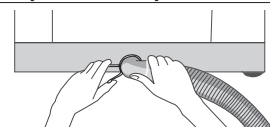



## CAUTIONS WHEN INSERTING THE DRAIN HOSE

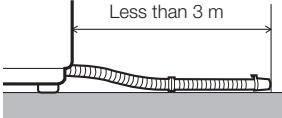
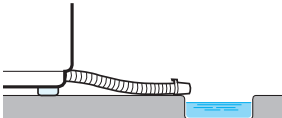
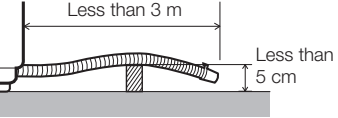
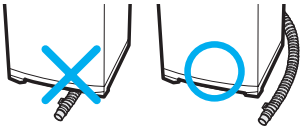

 <p><b>1.</b> Don't exceed more than 3 m when the drain hose is used by connecting with other hoses.</p>	 <p><b>2.</b> Be careful to drain water out at the end of the drain hose.</p>
 <p><b>3.</b> The doorsill shouldn't be more than 5cm.</p>	 <p><b>4.</b> Don't install the drain hose underneath the wash machine.</p>



### Test run

Make sure that you install your washing machine correctly by running the **Rinse+Spin** cycle after the installation is complete.

## ADDING DETERGENT

- 1.** Open the detergent drawer and then add the powder detergent into the detergent compartment.
  - 2.** Add detergent evenly so that it doesn't brim over the edge of the drawer.
    - Use a reasonable amount of detergent.  
If you use more detergent than the standard quantity or the water temperature is too low and the detergent does not dissolve in the water completely causing it to remain on the laundry and in the hose and tub, it may cause damage such as dirtying and discoloring the laundry.
    - If you use a powder detergent and it remains on the laundry, it may cause a bad odor. Rinse the laundry sufficiently in fresh water.
-  **CAUTION** If you spread a powder detergent over the laundry directly, it may result in discoloration. Make sure to insert it into the detergent compartment.
-  If the water pressure is low, the detergent may remain in the detergent compartment.

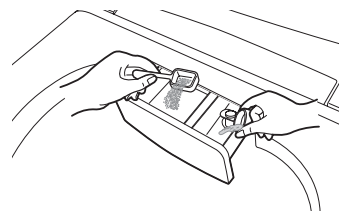

## ADDING FABRIC SOFTENER

- 1.** When the proper amount (one time dose) of fabric softener is stored in the softener inlet, it is automatically added during the last rinse cycle.
  - 2.** Do not add detergent, bleach or starch into the softener inlet.
  - 3.** Using too much softener may produce unsatisfactory results.
  - 4.** Do not open the lid during the Spin cycle. If added too early, its effectiveness will decrease.
  - 5.** Do not leave the softener in the softener dispenser for a long time as it may congeal.
-  If the water pressure is low, the fabric softener may remain in the softener compartment. In this case, put the fabric softener into the tub directly.

installation & maintenance\_17

# installation & maintenance

## WATER SUPPLY CONNECTOR FILTER

1. Pull out the filter and wash well.



2. Pull in the filter and connect the hose to the inlet water valve tightly.

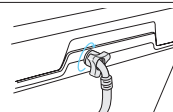

3. Check if there is a leakage.  
Note to tighten up the connector.

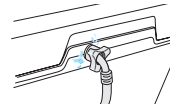

## CLEANING THE FILTER

Clean the filter net often to keep the washer clean.

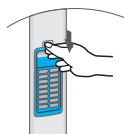

1. Push the upper part of the Hygiene filter and pull in.

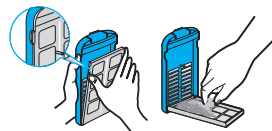

2. Open the cover as shown in the figure.



3. Clean the Hygiene filter.



4. Close the cover and insert the lower part of the filter in the basket first and then push the filter with "click" sound.

## CLEANING THE PUMP FILTER (OPTION)



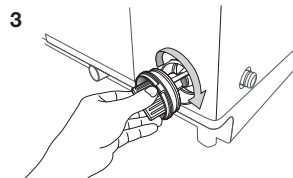
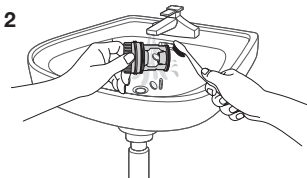
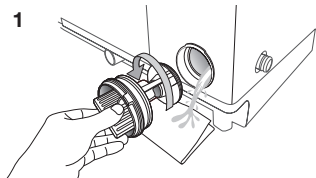



1. Place a rag or towel under the wash filter to avoid wetting the floor, and rotate the filter counterclockwise and pull it out.
2. Remove any dirt from the filter.
3. Return the filter to its place by rotating the filter clockwise until it locks into position.



## CLEANING THE DETERGENT COMPARTMENT

1. Separate the detergent compartment from the washer.
2. Separate and clean the Rinse-Cap from the detergent compartment.
3. Assemble the Rinse-Cap and insert the detergent compartment into the washer.

# troubleshooting

PROBLEM	CHECK
Washing machine won't work	<ul style="list-style-type: none"> <li>• Is the water tap opened?</li> <li>• Is the washer plugged in?</li> <li>• Is the power cut off?</li> <li>• Is there enough water?</li> </ul>
Water dose not drain 	<ul style="list-style-type: none"> <li>• Is the drain hose down?(No pump)</li> <li>• Is the drain hose frozen?</li> <li>• Is the drain hose clogged?</li> <li>• If the water dose not drain in 30 minutes, a buzzer will sound, and the remaining time indicator will show "5E".</li> </ul>
Water is not supplied 	<ul style="list-style-type: none"> <li>• Is the water tap opened?</li> <li>• Is the water cut off?</li> <li>• Is the water supply hose or hose connection clogged?</li> <li>• Is the water tap frozen?</li> <li>• If the water supply is not finished in 1 hour or there is no change in the water level 5 minutes (10minutes for some models) after the water supply has started, the buzzer rings and "4E" is displayed on the remaining time indicator.</li> </ul>
Spinning does not work 	<ul style="list-style-type: none"> <li>• Is the laundry spread out evenly in the washer?</li> <li>• In the washer set on a sturdy flat surface?</li> </ul>
Water is overflowed 	<ul style="list-style-type: none"> <li>• Restart after spinning.</li> <li>• If the error sign still indicates, call agency.</li> </ul>
This indicates that a Child Lock error occurred 	<ul style="list-style-type: none"> <li>• The error message blinks at a 1 second interval and the water is drained with an alarm sound. (Displayed message: "CL" or "dE")</li> <li>• This function is to prevent children from drowning when falling into the wash tub. When draining is complete and you turn the power off and then on, the washing machine will operate normally.</li> <li>• To clear "CL" display, after draining is complete, close the door of the washing machine, turn the power off and then on.</li> <li>• Is the Start/Pause button pressed?</li> </ul>
Water leakage error 	<ul style="list-style-type: none"> <li>• Check if the end of the drain hose is placed on the floor. (The hose should be hung over the pump - hose guide.)</li> <li>• Check if the drain hose is clogged by any foreign substances.</li> <li>• If the error remains, call the service center.</li> </ul>

# washing machine won't work?

PROBLEM	CHECK
The power is cut off.	Is the electric voltage normal?
	Is the washer plugged in? Plug in the electric cord. ➡ Water does not drain.
	Is the drain hose down? Put the drain hose down.
	Is the drain hose folded? Unfold the drain hose.
	Is the drain hose outlet clogged? Remove the waste cleanly.
Washing machine won't work.	Is the washer lid open? ➡ Close the lid.
	Is the Pause button on? ➡ Press the Start/Pause button one more time and check if the washer starts.
	Is enough water filled to the water level? ➡ If the water pressure is low, it takes a long time to start washing.
	Is the faucet closed? ➡ Open the faucet to supply water.
	Did you open the door during the spinning cycle? ➡ Close the door, and press the Start/Pause button to resume.
If the drain hose and spin basket are frozen, do as follows.	<ul style="list-style-type: none"> <li>• Add hot water to the frozen water tap and remove the drain hose. Soak into hot water.</li> <li>• Pour hot water into the spin basket for about 10 minutes.</li> <li>• Put a hot water towel on the drain hose connector.</li> <li>• If the drain hose defrosts, connect again and check for proper water draining.</li> </ul>
The water drains out immediately.	<ul style="list-style-type: none"> <li>• The drain is clogged with coins or pins. The drain hose is hung over the drain hose hook. Half fill the spin basket with water and try for spinning again.</li> </ul>
The water leaks at the water supply hose connector.	If the faucet connecting part is loose, water may leak. ➡ Repeat the assembling steps again. (Refer to "Connecting the water supply hose")
	Check if the rubber packing of water supply hose is in the right position. ➡ Screw tightly again.
	Is the water supply hose folded? ➡ Unfold the hose.
	If the water supply is too strong, water may leak. ➡ Close the faucet a little.
	Is water leaking from the faucet itself? ➡ Fix the faucet. Water is not supplied.

PROBLEM	CHECK
When no water is extracted.	Did you press the Start/Pause button after selecting the water supply? ➤ If the Start/Pause button is not pressed, water is not supplied. Press the Start/Pause button.
	Is the faucet closed? ➤ Turn on the faucet.
	Is the filter net at the water supply hose connector clogged with dirty matters? ➤ Clean the filter net by brushing with a toothbrush.
	Is the water supply cut off? ➤ If the water supply is suspended, turn off the faucet and power off.
Spinning makes loud noises and vibrations.	Check if the laundry is spread evenly in the washer. ➤ Spread out the laundry evenly and start again.
	Check if the washing machine levels on a sturdy flat floor. ➤ Set the machine at level.
	Is the handle for leveling legs loose? ➤ Adjust the legs on the feet for leveling.
	Is around the washing machine filled with unnecessary stuffs? ➤ Remove those unnecessary things away from the wash machine.

# specification

## WA65F5S2, WA70F5S2

MAX. MASS OF DRY CLOTH IN kg	WA65F5S2	6.5 kg	STANDARD WATER LEVEL	5	74 ℓ
	WA70F5S2	7.0 kg		4	65 ℓ
POWER CONSUMPTION	WASH	600 W		3	51 ℓ
	SPIN	360 W		2	44 ℓ
DIMENSIONS(mm)	610*670*983 (LOW BASE) 610*670*1003 (HIGH BASE)			1	34 ℓ
WEIGHT	41 kg		WATER USAGE	146 ℓ	
WATER PRESSURE	0.05~0.78 Mpa (0.5 ~ 8.0 kg-f/cm2)		SPIN SPEED	700 rpm	
WASHING TYPE	Stirring Type				

memo

---



QUESTIONS OR COMMENTS?

<b>Country</b>	<b>CALL</b>	<b>OR VISIT US ONLINE AT</b>
AUSTRALIA	1300 362 603	<a href="http://www.samsung.com/au/support">www.samsung.com/au/support</a>

Code No. DC68-03273G-02\_EN