

love^hcare™



SERENO COT

RCS 03

PLEASE KEEP THESE INSTRUCTIONS FOR FUTURE REFERENCE

loveⁿcare™

Congratulations on your new quality Love N Care product from our exclusive range of baby products. This exceptional design combines the most unique features that any baby product offers.

We are confident that you will appreciate its many highlights, including its reliability and durability. Your new product has been manufactured to comply with the Highest Quality Standards and comes with a 12-month warranty.

As you will soon learn there are many more great features about your new Love N Care product.



loveⁿcare™

Safety guidelines and instructions must always be followed before making use of this product, please retain these instructions for future reference.

This product complies with product standard:

AS/NZS 2172:2003 Cots for household use - Safety Requirements

WARNING

This cot has been designed for a child up to 25kg

Do not leave your child unattended when the dropside is in the lower position

RECOMMENDED MATTRESS SIZE: This cot has been manufactured for use with a mattress which measure 690mm wide by 1300mm long and 100mm in thickness.

The width and length are specific because it is important that the gaps between the mattress and the sides and ends of the cot will not exceed 40mm. This is to minimize the risk of a child's limb becoming caught in the gap. The thickness of the mattress has been specified to ensure that the depth of the cot is greater than 500mm with the mattress base in the lower position to minimise the risk of a child climbing or falling out of the cot.

WARNING TO PREVENT FALLS, THE MATTRESS BASE OF THIS COT SHOULD BE ADJUSTED TO THE LOWEST POSITION BEFORE THE CHILD CAN SIT UP.

The manufacturer's assembly instructions must be followed in detail to ensure all the safety features of the cot are not compromised.

Please ensure that the cot is placed at a reasonable distance from curtains, blinds, heaters and power points.

Please keep medication, string, elastic, small toys or small items, such as money out of reach from any position in the cot.

WARNING: TO PREVENT FALLS, THE MAXIMUM MATTRESS THICKNESS SHOULD NOT EXCEED 100mm.



Hardware Kit

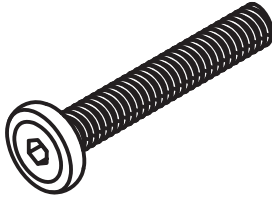
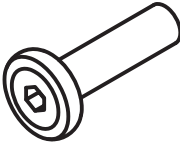
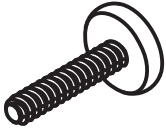
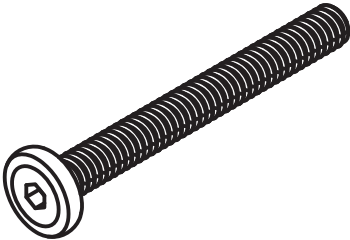
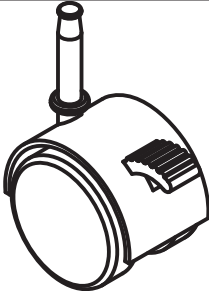
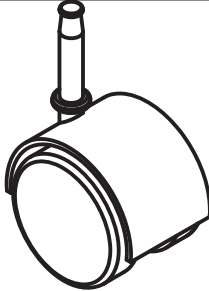
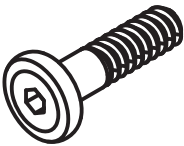
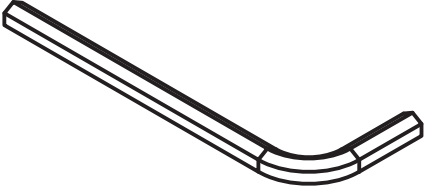

<p>1# 6*40MM 4PCS FOR BASE</p>	<p>2# 6*20MM 4PCS (4CAPPING NUTS) FOR BLOCK ENDS</p>	
		
<p>3# 6*55MM 4PCS FOR FIXED SIDE</p>	<p>4# 4* CASTOR WHEELS</p>	
		
<p>5# 6*25MM 2PCS FOR DROP SIDE</p>	<p>ALLEN KEY</p>	
		

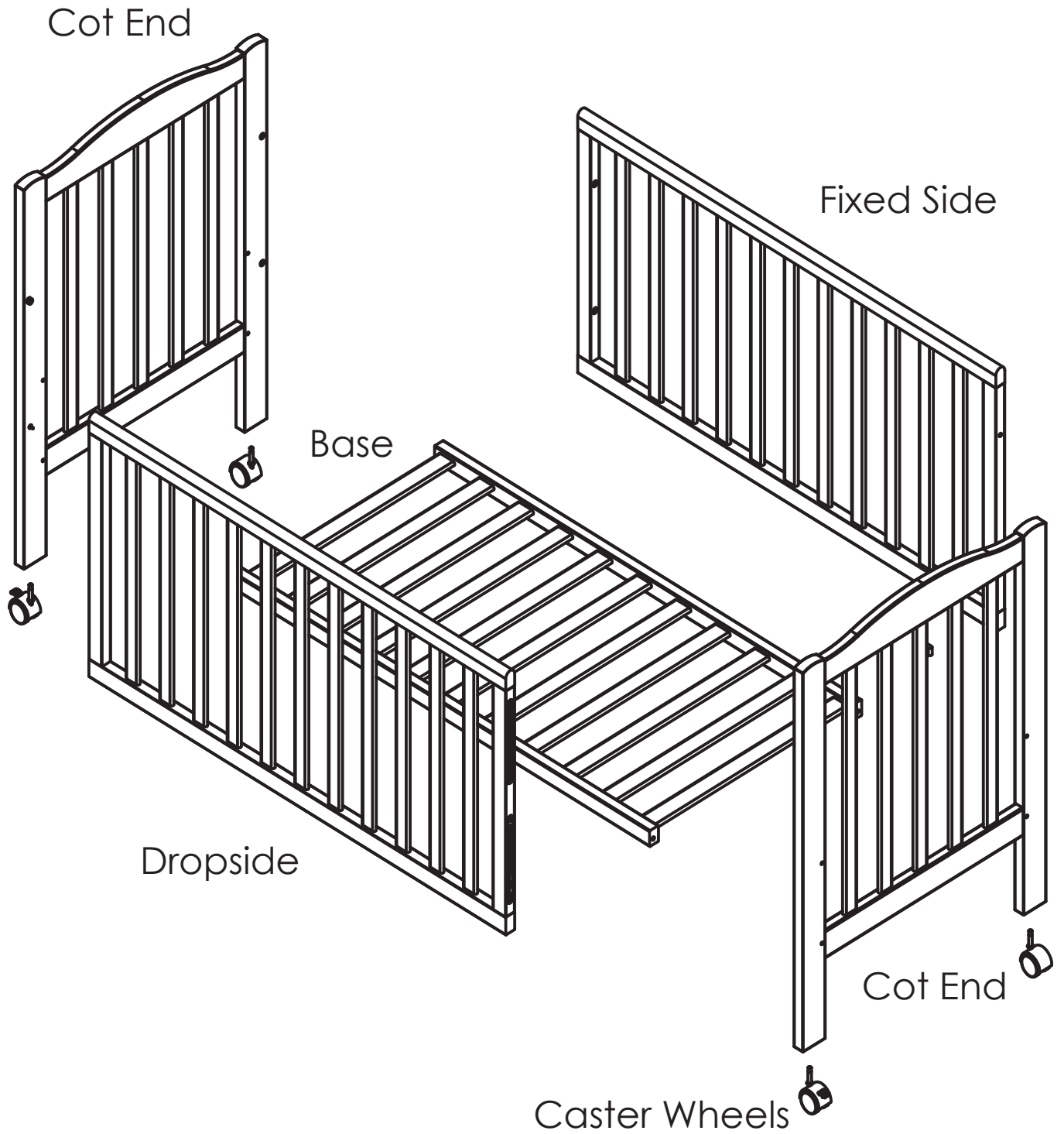
Parts List



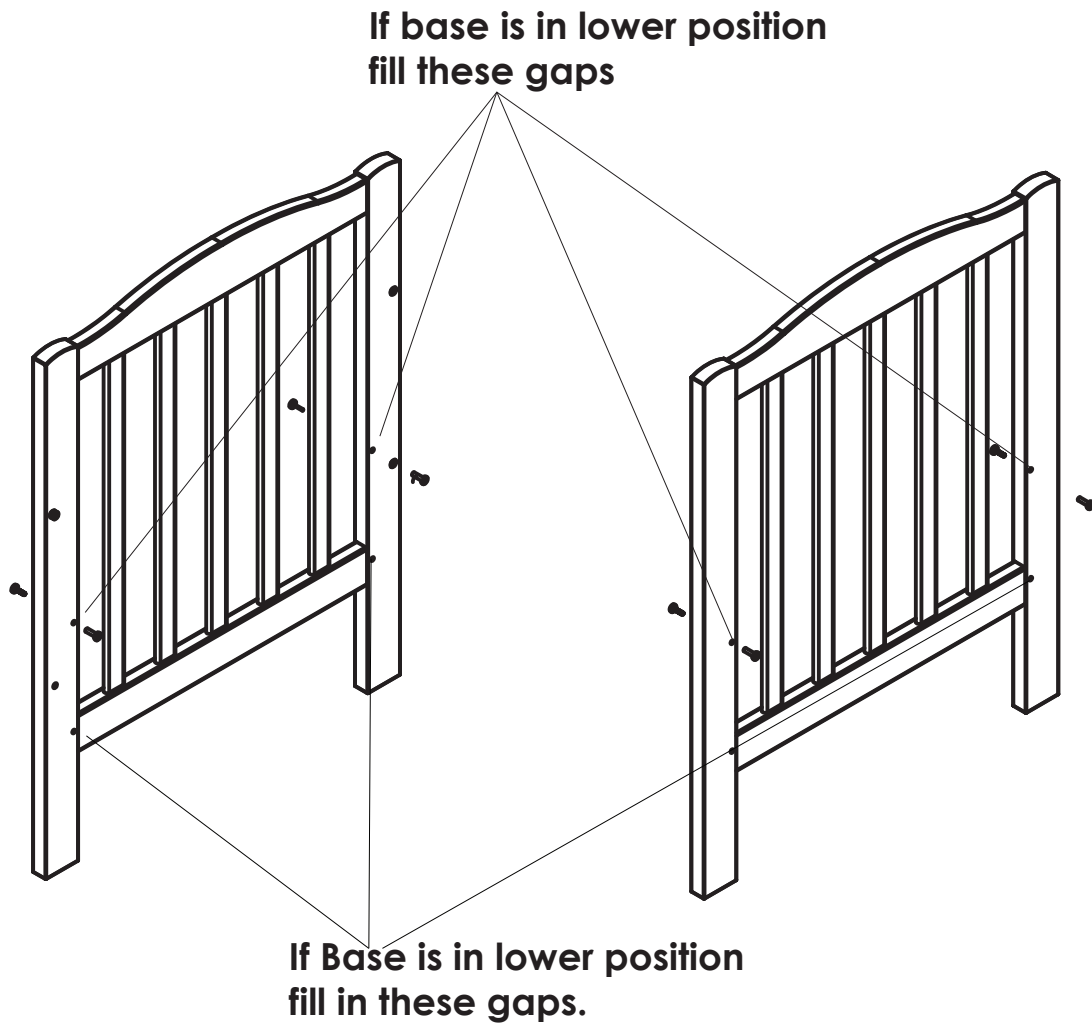

Assembling Cot

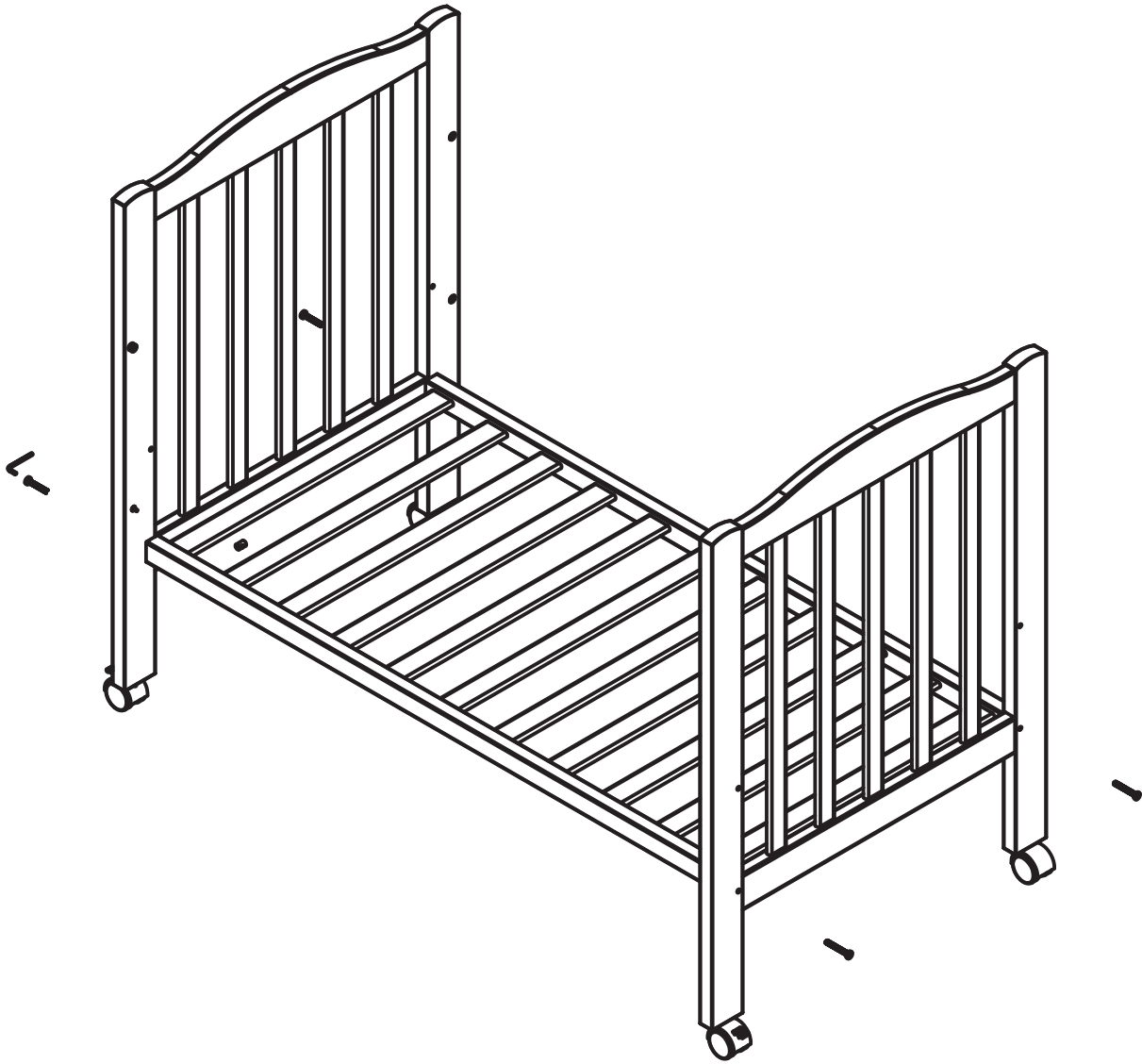

2# 6*20MM	4PCS (4CAPPING NUTS) FOR BLOCK ENDS	ALLEN KEYS
		

If placing the base in the **lower position** fill in the holes with the capping nuts #2. Tighten with the allen Key

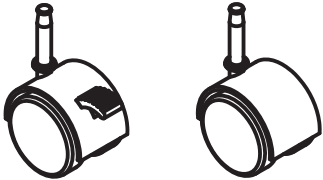

<p>1# 6*40MM 4PCS FOR BASE</p>	<p>ALLEN KEYS</p>
	
<p>4# 4* CASTOR WHEELS</p>	
	

Attach the base between the cot ends, and insert the 4 (1#) bolts. Do not tighten completely yet. Insert 4 (4#) castor wheels on the legs of the cot ends.

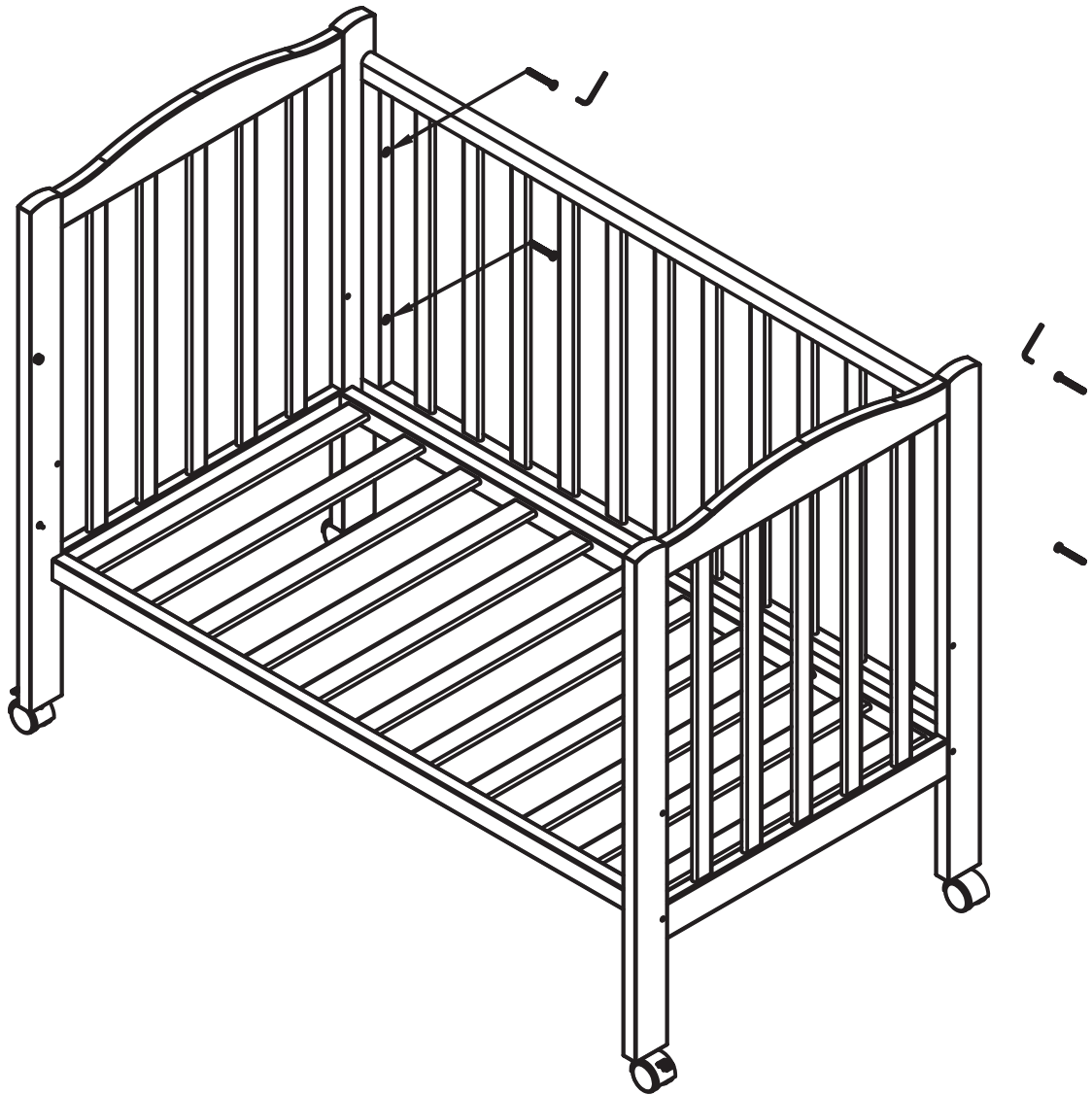

3# 6*55MM 4PCS FOR FIXED SIDE	ALLEN KEYS
	

Insert the 4 (3#) bolts to attach the fixed side to the cot ends.
Tighten with the Allen Key but not completely.

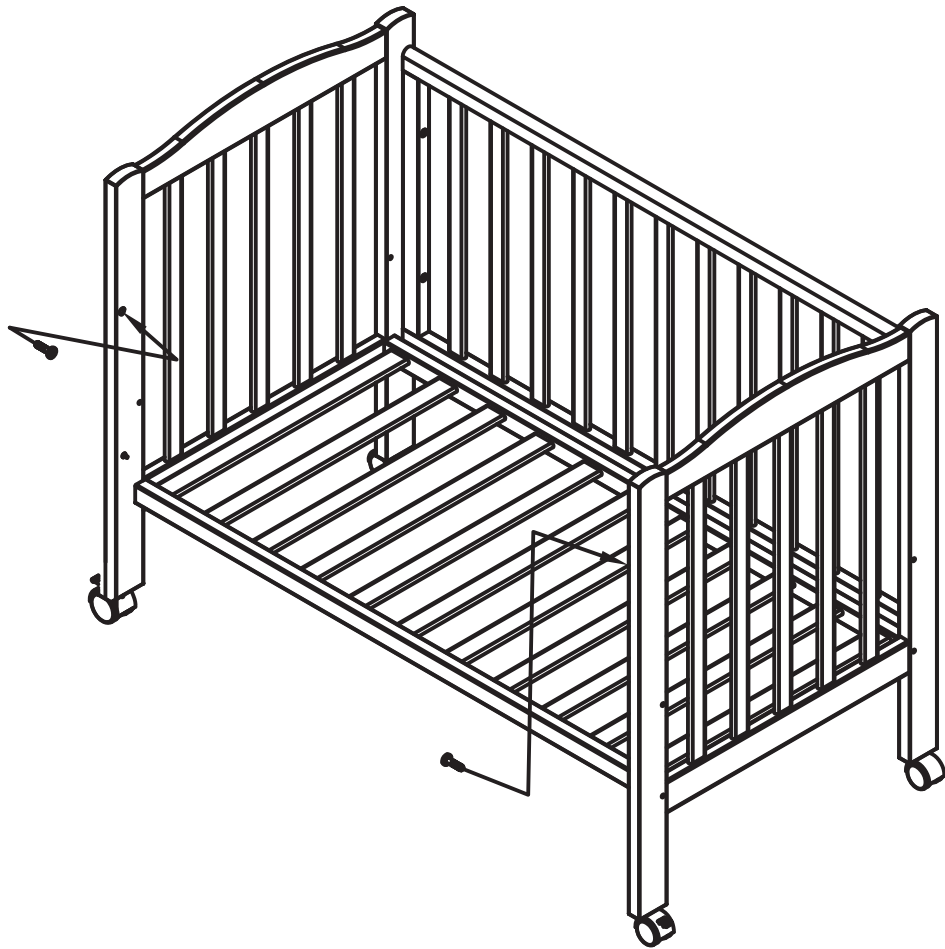

5# 6*25MM 2PCS FOR DROP SIDE	ALLEN KEYS
	

Insert the 2 (5#) screws into the top position shown on the cot ends.
Tighten with the Allen key.

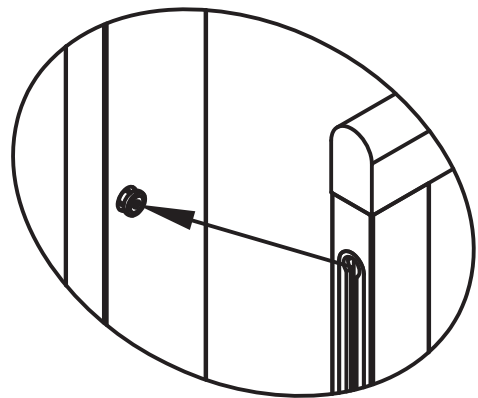
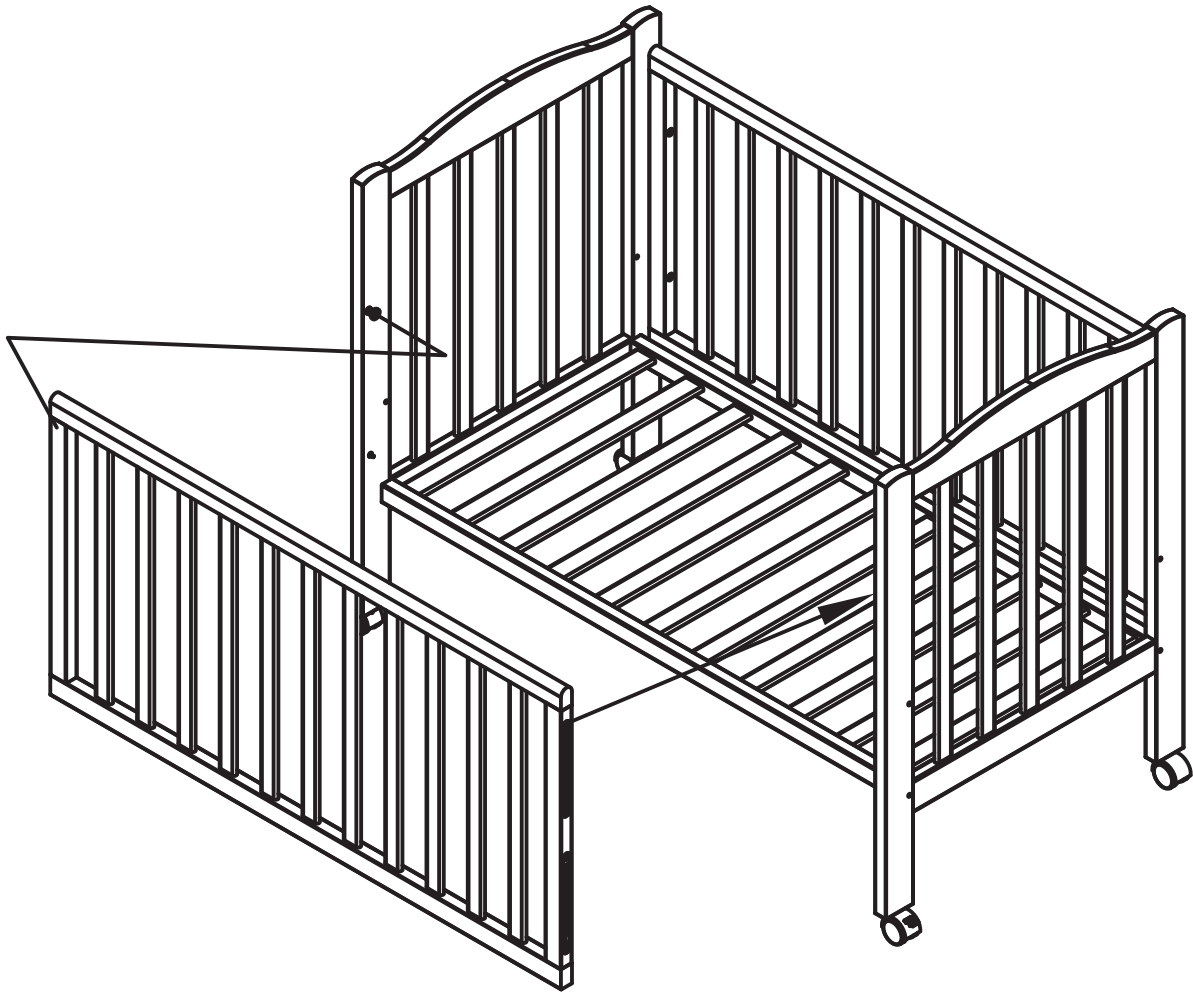

Place the dropside between the cot ends and place the top inner side of the dropside rail onto the #5 screw we had just inserted in the previous step. Do this for both ends of the dropside.

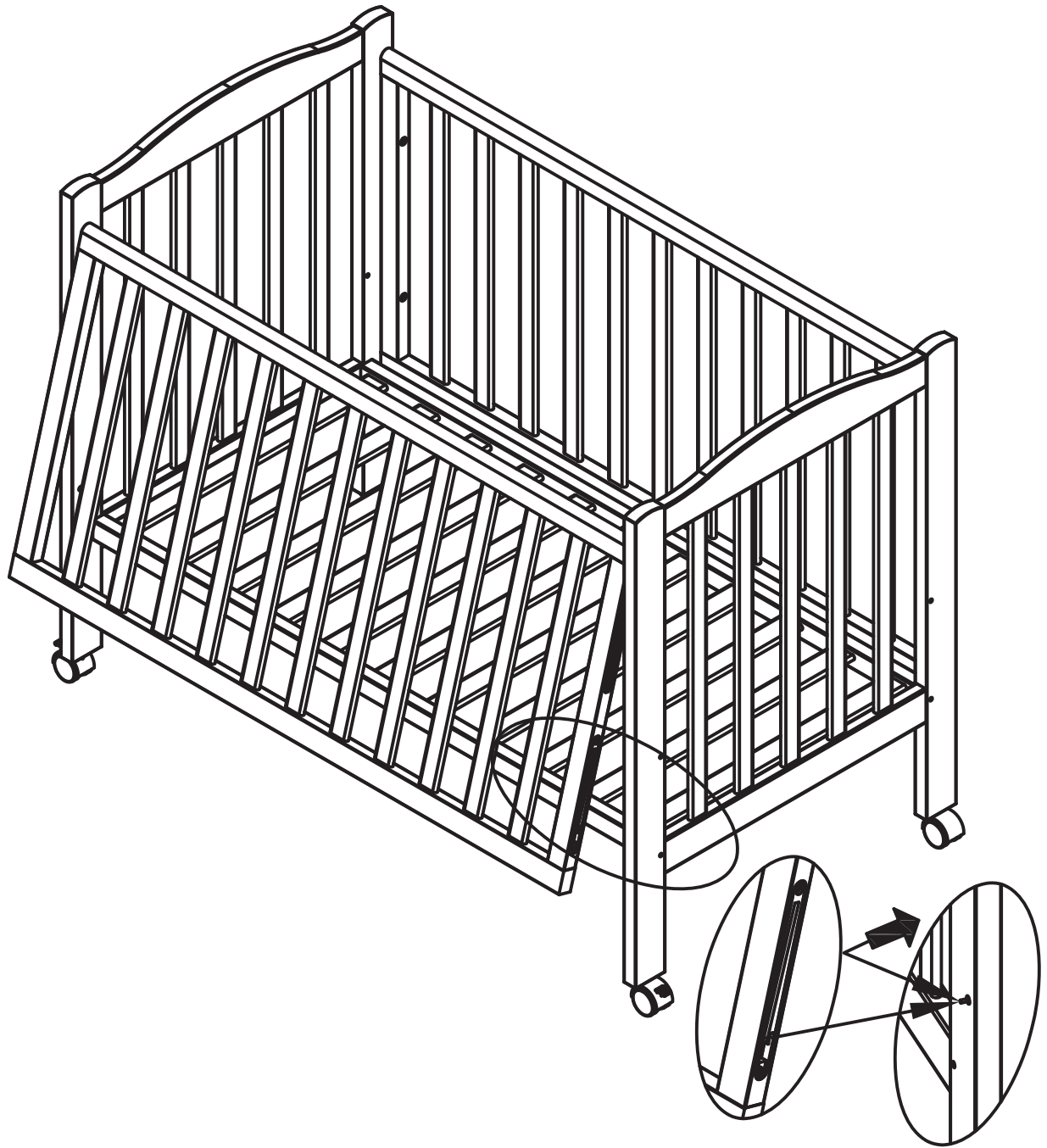

Now with the top of the Dropsides attached to the ends of the cot you should now align the bottom of the dropsides with the catch on the cot sides. They should lock into place.



Test to see that the dropside is functioning correctly,

1. Raise the dropside upwards;

2. Push the dropside inwards with your knee;

Please make sure you push in the centre and not from the edges as it will not work

3. Push the Dropside downwards.

Please make sure you push down from the centre.

If you would like to raise the dropside just push it upwards.

If all is functioning well. Tighten all screws.



CARE AND MAINTENANCE

ALL LOVE N CARE PRODUCTS HAVE ONE YEAR WARRANTY FROM THE DATE OF PURCHASE.

IT IS RECOMMENDED TO REGULARLY INSPECT AND MAINTAIN MOVEMENT OF LOCKING DEVICES AND SECURITY OF ESSENTIAL COMPONENTS.

REGULARLY CHECK ALL PARTS FOR WEAR AND TEAR.

YOUR FURNITURE MAY BE CLEANED BY WIPING WITH A DAMP CLOTH AND DRYING WITH A SOFT CLEAN CLOTH. DO NOT USE ABRASIVES, BLEACH, ALCOHOL OR AMMONIA-BASED HOUSEHOLD POLISHES.

TAKE CARE WHEN HANDLING OR MOVING THE FURNITURE. CARELESS HANDLING MAY CAUSE DAMAGE.

CHECK THE CHEST SCREWS AND LOCKS TO MAKE SURE THEY ARE ALL KEPT IN GOOD WORKING ORDER.

IF ANY OF THE PARTS ARE MISSING OR BROKEN YOU SHOULD CONTACT THE MANUFACTURER AND DISCONTINUE USING THE COT UNTIL THEY ARE REPLACED.

LOCK MAINTENANCE: PUT LUBRICATING OIL EVERY 3-6 MONTHS TO ENSURE THE LOCK RUNS SMOOTHLY.

PLEASE MAKE SURE THAT THE COT IS PLACED ON A LEVEL FLOOR TO ENSURE THE LOCKING MECHANISM FUNCTIONS CORRECTLY.

WARRANTY AGAINST DEFECTS.

All Love n care products are guaranteed for twelve months from the date of purchase.

Our goods come with guarantees that cannot be excluded under the Australian Consumer Law.

You are entitled to a replacement or refund for a major failure and for compensation for any other reasonably foreseeable loss or damage. You are also entitled to have the goods repaired or replaced if the goods fail to be of acceptable quality and the failure does not amount to a major failure.

This covers against faults which develop through faulty materials and workmanship. Misuse, accidental damages, normal wear and tear or neglect are not covered.

If a fault becomes apparent, please return the item to the store of purchase with your receipt.

You must inform the store what the defect is. We will then arrange for its repair or it will be assessed for replacement as expediently as possible. The benefits of this warranty are in addition to other right and remedies under the law in relation to the goods or services to which this warranty relates.

If you are unable to return the item to the store of purchase, you can contact Love N Care on free call 1300 732 599. We will then organise for either somebody to inspect the item or arrange for a courier to pick it up and return it back to you.



Contact Us

Head Office:

Love N Care Pty Ltd.
297-299 Canterbury Rd, Revesby
NSW 2212 Australia
Contact No: 02 9774 4655
Fax: 02 9774 4633
Email: info@lovencare.com.au
Website: www.lovencare.com.au

Brisbane
7-9 Eileen Street
Underwood QLD 4119 Australia
Contact No: 07 3290 4217
Fax: 07 3209 5019

let's be friends!

 <http://www.facebook.com/lovencare1>

 http://twitter.com/love_ncare



100% AUSTRALIAN OWNED SINCE 1984

lovehncare™
lovencare.com.au