

WA75G9T

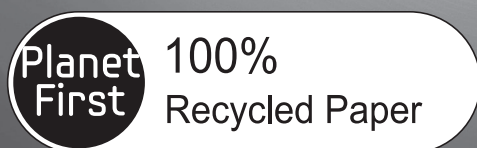

# Washing Machine user manual



This manual is made with 100% recycled paper.

imagine the possibilities

Thank you for purchasing a Samsung product.

To receive a more complete service, please register your product at

[www.samsung.com/register](http://www.samsung.com/register)



DC68-02961M-02



# features

---

- **Water Saving Program**

Designed to address concerns on water consumption. Less water is used per wash, while continuing to deliver a clean and effective washing performance. It is certified from WELS (Water Efficiency Labelling and Standards) scheme in Australia.

- **Last Settings Feature**

This option loads the previous course settings.

The Last Settings feature automatically remembers the last course that was run, making it possible to use the same settings as the last time the washer was used without having to manually select all the settings.

- **Diamond Drum**

The diamond shaped drum creates a high water pressure, removing dirt from the laundry effectively. The diamond drum minimizes fabric damage extending the lifetime of the fabric. The glittering inner tube is both beautiful and powerful in the wash effect it creates.

- **Fuzzy Control**

Fuzzy control operates with best washing program by sensing the washload like artificial intelligence.

- **Tempered Transparent Door**

Lets you observe while the washer is operating. Check on your laundry's progress at any time.

- **Eco Storm**

A giant pulsator creates a powerful water current, which is further accelerated by a tilted center pulsator spinning at 360°. The resulting waterfall effect speeds up the circulation of the water to achieve a cleaner wash using just a small amount of water. (A better wash performance is achieved.)



- **Magic Filter**

This unique Magic Filter ensures that all the lint inside the tub is captured for top quality filtering results to deliver consistently effective cleaning results.

- **CHILD-LOCK Function**











This is a device to protect children from being accidentally hurt while playing with the washer. (For more information, see page 11, 14.)

# safety information

Throughout this manual, you'll see Warning  and Caution  notes. These warnings, cautions, and the important safety instructions that follow do not cover all possible conditions and situations that may occur. It's your responsibility to use common sense, caution, and care when installing, maintaining, and operating your washer. Samsung is not liable for damages resulting from improper use.

## IMPORTANT SAFETY SYMBOLS AND PRECAUTIONS

What the icons and signs in this user manual means:

 <b>WARNING</b>	Hazards or unsafe practices that may result in <b>severe personal injury or death</b> .
 <b>CAUTION</b>	Hazards or unsafe practices that may result in <b>minor personal injury or property damage</b> .
 <b>CAUTION</b>	To reduce the risk of fire, explosion, electric shock, or personal injury when using your washer, follow these basic safety precautions:
	Do NOT attempt.
	Do NOT disassemble.
	Do NOT touch.
	Follow directions explicitly.
	Unplug the power plug from the wall socket.
	Make sure the machine is grounded to prevent electric shock.
	Call the service center for help.

**These warning signs are here to prevent injury to you and others.**

**Please follow them explicitly.**

**After reading this section, keep it in a safe place for future reference.**

 Read all instructions before using the appliance.

As with all any equipment using electricity and moving parts, potential hazards exist. To safely operate this appliance, become familiar with its operation and exercise care when using it.

Install and store your washer inside, away from exposure to weather.

Install and level your washer on a floor that can support its weight.

 Your washer must be properly grounded. Never plug it into an ungrounded outlet.

Position the washer so that a wall plug is accessible after the installation is completed.

# safety information



To reduce the risk of fire or explosion:

- Do not wash items that have been washed, soaked, or treated with gasoline, dry cleaning solvents, or other flammable or explosive substances. They give off vapors that could ignite or explode. Rinse by hand any material that has been exposed to cleaning solvent or other flammable liquids or solids before putting in your washer. Be sure that all traces of such liquids, solids, and fumes have been removed. Dangerous substances include acetone, denatured alcohol, gasoline, kerosene, certain liquid housePause cleaners and spot removers, turpentine, waxes, and wax removers.
- Do not put gasoline, dry cleaning solvents, or other flammable or explosive substances into the washer.
- Under certain conditions, hydrogen gas may be produced in a hot water system – such as your hot water heater - that has not been used for two weeks or more. **HYDROGEN GAS IS EXPLOSIVE.** If your hot water system has not been used for two weeks or more, turn on all hot water faucets in your home, and let the water flow for several minutes before using your washer. This will release any hydrogen gas build-up. Since hydrogen gas is flammable, do not smoke or light an open flame during this time.

Ventilate the room immediately without touching the power plug if there is a gas leak.



Unplug the power cord before servicing your washer.



Do not reach into the appliance when the tub is moving.



Do not reach under the appliance with your hands or with an object as you may be injured by the spinning parts beneath the washer.



Do not let children play on or in your washer. Children may be seriously injured if trapped inside.



Do not let children attempt to look into the washer as falling into the washer is extremely dangerous and may be fatal.



This appliance is not intended for use by persons (including children) with reduced physical, sensory or mental capabilities, or lack of experience and knowledge, unless they have been given supervision or instruction concerning use of the appliance by a person responsible for their safety.

Children should be supervised to ensure that they do not play with the appliance.



Do not repair, replace, or service any part of your washer yourself unless you fully understand the recommended user-repair instructions and have the skills to carry them out. Work done by an unauthorized person may void your warranty.

Store laundry detergents and other laundry supplies in a cool, dry place out of children's reach.

Disconnect the hoses and turn off the water when not using the washer.

If the power cord is damaged, it must be replaced by the manufacturer, a service agent or similarly qualified person in order to avoid a hazard.

Do not forcefully bend the power cable or place any heavy objects on the cable.

Do not touch the power cord with wet hands.

Do not overload the power outlet with too many appliances.

## 4\_safety instructions



If this appliance is supplied from a cord extension set or electrical portable outlet device, the cord extension set or electrical portable outlet device must be positioned so that it is not subject to splashing or ingress of moisture.

Do not install the washer nearby electrical implements and do not place any candles or cigarettes on the washer.

Do not go near the washer if it is flooded or under water, as there is a risk of electric shock. Unplug the washer and drain the water completely.



Do not combine chlorine bleach, ammonia, or acids (such as vinegar or rust remover) in the same wash. The fumes that can form when any of these items are combined are hazardous.

Do not machine wash fiberglass materials. Small particles can stick to fabrics washed in subsequent loads and cause skin irritation.

If this appliance is supplied from a cord extension set or electrical portable outlet device, the cord extension set or electrical portable outlet device must be positioned so that it is not subject to splashing or ingress of moisture.



Before disposing of your washer, remove the lid so that children or small animals cannot get trapped inside.

Connect the washer to the main water supply using a new set of hoses. Do not reuse an old set of hoses.

Water inlet hoses deteriorate over time. Check the hoses periodically for bulges, kinks, cuts, wear, and leaks, and replace them as needed and at least every five years.

Before each wash, empty the pockets of your laundry. Small, irregularly shaped hard objects, such as coins, knives, pins, and paperclips could damage your washer. Do not wash clothing with large buckles, buttons, or other heavy metal objects.

If the washer does not stop within 15 seconds after you open the lid, call a service agent immediately.

Connect the grounding wire to the shell plate, and bury it under at least 10 in (25 cm) of earth: Alternatively, connect the ground wire to the appropriate pin on a properly grounded power receptacle. Never connect the wire to a telephone line, lightning rod, or gas pipe.

For washers with ventilation openings in the base, that a carpet must not obstruct the openings.



The product you have purchased is designed for domestic use only.

The use for business purposes qualifies as product misuse. In this case, the product will not be covered by the standard warranty provided by Samsung and no responsibility can be attributed to Samsung for malfunctions or damages resulting from such misuse.

Do not use the strong acid cleaning agent.

# contents

---

<b>SETTING UP YOUR WASHER</b>	7	Description of part
	10	How to wash automatically depends on the laundry
	11	Control Panel

<b>MANUAL FUNCTIONS</b>	16	Manual functions
-------------------------	----	------------------

<b>INSTALLATION &amp; MAINTENANCE</b>	17	Environment
	17	Levelling
	17	Connecting the water supply hose
	18	Assembling the rat protection panel
	18	How to connect the drain hose
	20	Adding detergent
	20	Adding fabric softener
	21	Water supply connector filter
	21	Cleaning the filter
	22	Cleaning the pump filter
	22	Cleaning the detergent compartment

<b>TROUBLESHOOTING</b>	23	Troubleshooting
------------------------	----	-----------------

<b>WASHING MACHINE WON'T WORK?</b>	24	Washing machine won't work?
------------------------------------	----	-----------------------------

<b>SPECIFICATION</b>	25	Specification
----------------------	----	---------------

# setting up your washer

## DESCRIPTION OF PART

The User's Manual is for common use.

Make use of the User's Manual depending upon your washing machine model.

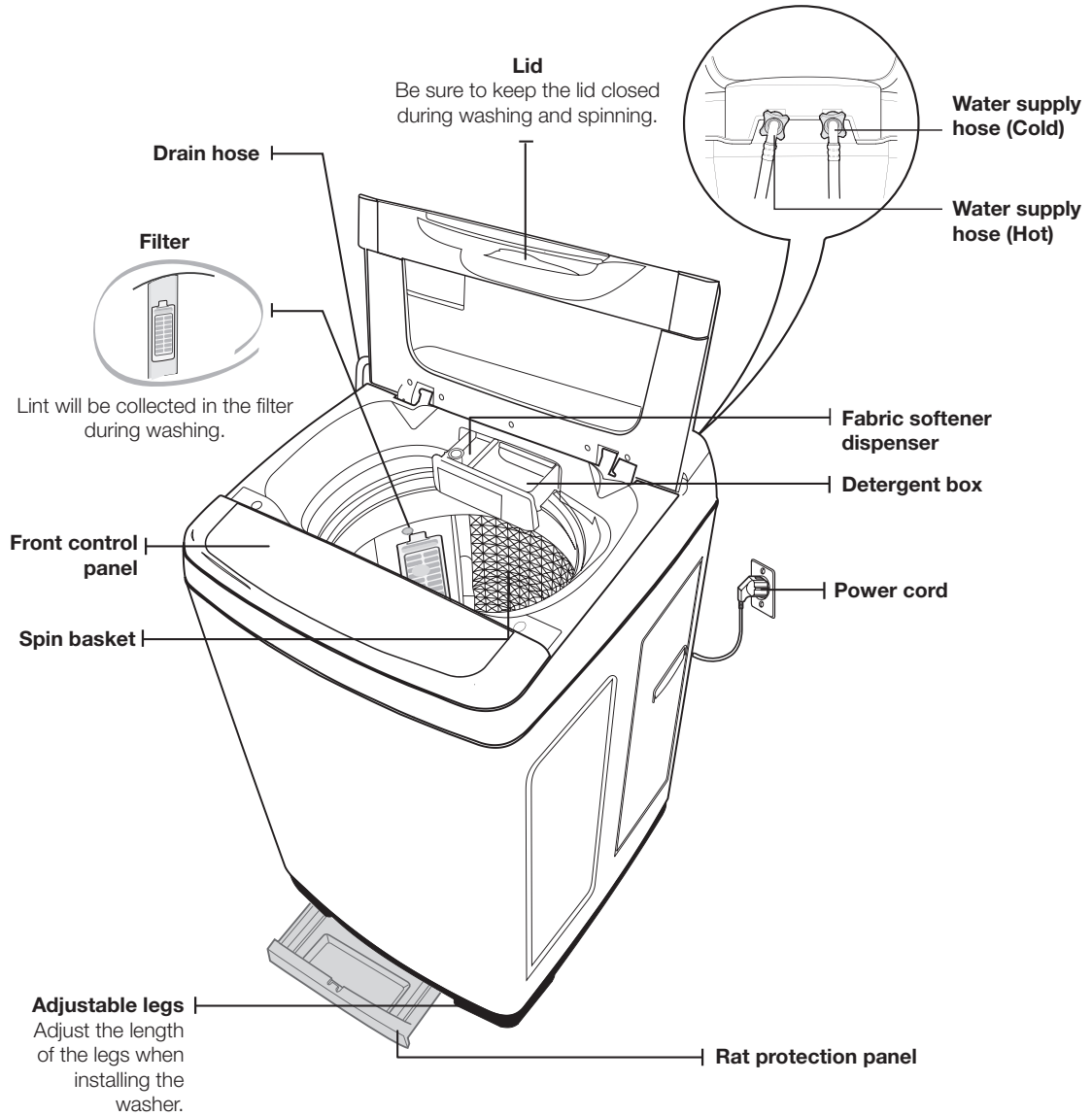

# setting up your washer

## CHECKING BEFORE WASHING AND CARING FOR GARMENTS

Must follow the checkpoints in order to avoid machine problems or damages on garments.

- If the below problems are caused by customer's faults, separate service fee will be charged.

### Checkpoints Before Starting Washing

Check if the clothes are bleaching or not.

- Add liquid detergent to a white towel and the garment where you can't notice well. Then, rub together strongly. Check if the color transferred to the towel.
- Be careful for scarves and imported clothes since they are easily discoloring.
- Check for stains or partial dirt.
- If stains are found, use the towel wet with detergents to rub on in a single direction.
- Before washing, the sleeves, collar, dress hem and pockets are pre-treated by brushing with detergents.

The wrinkle-processed clothes made of wool are specially treated by fixing them with threads before washing. The threads shall be removed after the clothes are dried.

### Not washable laundry

Clothes those are easily transformable even by soaking in water.

- Even by soaking in water, neckties, brassieres, jackets, suits and coats can be easily transformed like shrinking and discoloring on the garment surfaces because they are mostly made of rayon, polynosic, cuff and their blend fabrics.
- The wrinkle-processed, embossed, or resin processed products are easy to transform even by soaking in water.
- Easily discoloring products made of cotton and wool, wrinkled silk, leather products, leather accessory, leather ornamented clothes and its accessory.
- Don't wash those clothes without handling guideline or material indication tag.

### About Detergent

- When detergents are not dissolving well, use warm water (about 40°C) to dissolve the detergent.
- For best results it is recommended to mix detergent with 1 litre of warm water before adding to the machine during the fill process.



- Use an appropriate amount.
- Even if excess amount of detergent is used, there is not much difference in washing result. It may cause damages to the garments because rinsing is not enough.
- The bleaching agent may cause damages to garments since it is strong alkali.
- Do sufficient rinsing because the powder detergent is easily remained on the garments causing bad odors.
- If too much detergent is used or cold water is used, it doesn't dissolve completely and remain on the garments, hose or spin basket, causing contamination on clothes.
- In case of reserved washing, detergents must be put in the detergent box. If the powder detergents are spread on laundry directly, it may cause discoloration.



## CARING FOR CLOTHES BEFORE WASHING

### Take out personal belongings from pockets.

- Caution, Check the pockets! Hairpins and coins cause damages to clothes and washing machine. They make noise and problems to the machine. Must check the pocket.



### If pants zippers are open while washing, the spin basket may be damaged. The zipper should be closed and fixed with a string before washing.

- Metal on the clothing may cause damage to the clothes and the tub.
- Turn clothing with buttons and embroidered clothes inside out before washing them.
- Clothing with long strings may become entangled with other clothes, and may cause damage to the clothing. Be sure to fix the strings before washing.

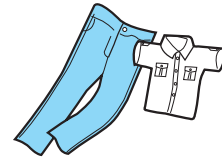

### Waterproof clothes (Ski Wear, Diaper Covers, Footboards) are not allowed for washing.

- This may cause the laundry to be ejected or cause the washing machine to vibrate abnormally, which may result in personal injury or damage the washing machine, the floor or the clothing. (Diapers, waterproof clothing, raincoats, umbrella covers, skiwear, car cover sheets, and sleeping bags, etc.).
- When the tub rotates, water may become trapped in the waterproof clothing or fabric and can collect in a corner, causing abnormal vibrations. In addition, the laundry rises and may be ejected and cause personal injury.

### Shake the dirt or soils from clothes.

- Soil and sands may rub delicate garments to cause damages and the washing result may be unsatisfactory.

### Do pre-washing for white socks, sleeves, and collars before the main washing.

- For stains and dirt on collars, sleeves, hems, and pockets, apply some detergent to them and apply it lightly with a brush before washing.
- Use powdered or liquid detergent. Do not use soap as the tub may become dirty from the dirt on it.

### Turn inside out for those nappy clothes before washing.

- If clothes have too much foreign matter, separate them for washing. Other clothes may pick up those dirty matters (dirt, thread).
- Wash black colored clothes and cotton towels separately. If they are washed together, towels may pick up dirty matters. Check before washing.

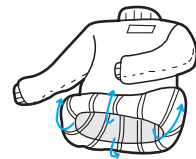

### Cashmilon and those garments having big volume and lightweight (eg. Lase-decorated clothes, lingerie, nylon stocking, synthetic fabrics etc.) may rise and cause damages to the clothes and problems to the machine. Use the laundry net or wash them separately.

- Must put those long stringed clothes, lase-worked clothes, bed cover sheet, wool clothes into a laundry net before washing.
- Put delicate clothes in the laundry net.
- Use only those commercial laundry net for washing.

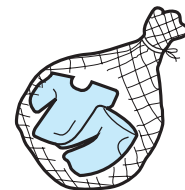

### Curtains, floating garments or blue jeans shall be pressed not to float on the water.

- If they are floated on the water, press Start/Pause button to stop and press them to sock in the water. If the washing goes on with clothes floating on the water, it may cause damages to the clothes and the washing machine as well as unsatisfactory washing result.

# setting up your washer

## HOW TO WASH AUTOMATICALLY DEPENDS ON THE LAUNDRY

### Before starting washing, check the following;

- Connect the water supply hose to the water tap. Leave a tap open. Plug the power cord in. Make sure to lay down the drain hose.

### Washing for the first time

Before washing clothes for the first time, you must run a complete cycle without clothes.

To do this:

1. Press the **Power** button.
2. Open the detergent drawer and insert a little detergent.
3. Turn on the water supply to the washing machine.
4. Press the **Start/Pause** button.  
This will remove any water from the manufacturer's test run remaining in the machine.

### Special notes!

#### Automatic Sensing Function

- According to the selected program, the amount of laundry is automatically sensed and then the appropriate water level, wash time, rinse cycle, and spinning time are automatically selected for the automatic wash.
- After the power is on, a program is selected and **Start/Pause** button is pressed. Then, the washing board starts spinning without water. This action senses how much laundry is in the washing basket, not a machine problem. After this sensing process, water supplies automatically.

#### Adding Detergent and Softener

- It senses the amount of laundry and indicates the water level and amount of detergent. Then, it starts water supply right away.
- During the water supply, it is possible to open the detergent box and add detergent. However, it is better to press **Start/Pause** button to stop water supply and add detergent. Close the lid and press **Start/Pause** button again. This way is much more convenient.
- If the softener is inserted in the softener dispenser, it automatically adds in at the last rinsing cycle.

#### Put the laundry into the washer and add detergent, too.

- Be careful not to overload. Use right detergent for the fabrics you are washing.
-  • If the lid is open while running, the washing machine is stopped automatically for safety. (Except, water supply continues while the lid is open.)
- When hot water is selected, both cold and hot water are supplied for the first 20 seconds in order to protect the clothes.
- Possible to control the washing time, rinsing cycle, and spinning time at every program during the washing.

## CONTROL PANEL

For more details, see control panel of your washing machine.

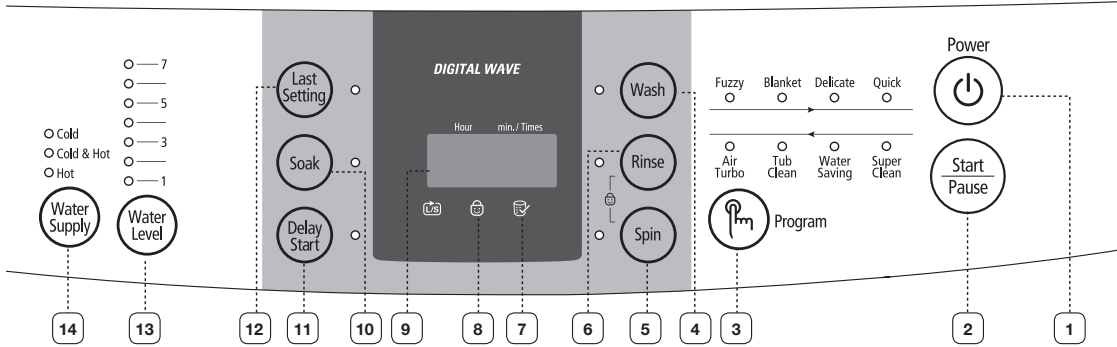

<b>1</b>	<b>POWER BUTTON</b>	Press this button once to operate. Press it again to turn the power off.
<b>2</b>	<b>START/PAUSE BUTTON</b>	Use to pause and restart the operation. To change the washing procedure during an operation, press this button to stop, and again to restart after changing the procedure.
<b>3</b>	<b>PROGRAM SELECT BUTTON</b>	Each time the button is pressed, the washing program changes; Fuzzy → Blanket → Delicate → Quick → Super Clean → Water Saving → Tub Clean → Air Turbo
<b>4</b>	<b>WASH BUTTON</b>	Press this button to perform a wash only or to adjust the washing time. You can set the wash time from between 4 to 30 minutes.
<b>5</b>	<b>SPIN BUTTON</b>	Press this button to perform a spin cycle only or to adjust the spin time. You can set the spin time from between 0 to 9 minutes. When only a spin is selected, the spin time will be different from the total remaining time. This is because the total remaining time includes the actual spin time and the times for water draining and stopping.
<b>6</b>	<b>RINSE BUTTON</b>	Press this button to perform a rinse only or to adjust the rinse count. You can set the rinse count up to five times.
<b>7</b>	<b>TUB CHECK FUNCTION</b> Tub Check /	If the Tub Check indicator on the display blinks (it blinks for 3 minutes), run the Tub Clean course. The Tub Clean function removes dirt from the tub to keep the laundry clean.
<b>8</b>	<b>CHILD-LOCK FUNCTION</b> 	This is a device to protect children from being accidentally hurt while playing with the washer. <ul style="list-style-type: none"> <li>How to start the Child-Lock function: <ul style="list-style-type: none"> <li>- Press the "Power" button to go to an initial washing mode.</li> <li>- By pressing "<b>Start/Pause</b>" button, you start washing and in case Child Lock function is needed during the laundry</li> <li>- Press both the "Rinse" and "Spin" buttons at the same times.(for 3 seconds) (Note: You cannot perform the function without the "Power" button on.)</li> </ul> </li> <li>To release the function of Child-Lock: In case the "Child-Lock" is programmed, press both the "Rinse" and "Spin" buttons at the same time.</li> </ul>

# setting up your washer

<b>9</b>	<b>REMAINING TIME, DELAY START TIME, ERROR DISPLAY</b>	Displays the remaining wash time. Displays the reserved delay start time. Displays the error state if a problem occurs in the washing machine so that you can take action.
<b>10</b>	<b>SOAK BUTTON</b>	Press this button to perform a soak wash. You can set the soak time from between 10 to 60 minutes.
<b>11</b>	<b>DELAY START BUTTON</b>	Press this button to finish the wash at a specified time. Turn off your washing machine to cancel a reserved delay start. You can set the delay start time from between 3 to 19 hours.
<b>12</b>	<b>LAST SETTING</b>	Press this button to load the settings for the last course. Perform a wash course using the last used settings without having to enter them manually again. Your choices are automatically saved when you press the Start/Hold button. To use a memorized course, press the Last Settings button and then press the Start/Hold button. - The memorized functions will be displayed on the panel.  The Delay start and Water level settings are not automatically saved and will be reset after the wash.
<b>13</b>	<b>WATER LEVEL BUTTON</b>	The water level is automatically adjusted. However, you can select the water level manually by pressing this button.
<b>14</b>	<b>WATER SUPPLY BUTTON</b>	Each press of the button cycles through the type of water, Cold → Cold + Hot → Hot → Cold

## FUZZY PROGRAM

Selects the best washing program automatically.

1. Press the **Power** button to “On”.
2. Press the **Start/Pause** button.  
Water level is selected automatically. Washing rinsing, and spinning follow.  
If you want to pause, press the **Start/Pause** button again. You can change the program when paused.
3. Close the lid.
4. Press the **Start/Pause** button.

## BLANKET PROGRAM

(Big volume laundry like blanket and bed cover sheets)

1. Press the **Power** button to “On”.
2. Press the **Program** select button once.
3. Press the **Start/Pause** button.  
Washing, rinsing, and spinning follow. If you want to pause, press the **Start/Pause** button again. You can change the program when paused.

4. Close the lid.



- Fold those big volume laundry (blanket and bed cover sheets) in the following way before adding into the spin basket.
- Do not wash the electric blanket and carpets.
- Get a laundry net for those light and big volume laundry (eg. Cashmeres) because they might rise in the water and get damaged.

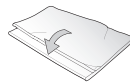

- When you wash unwieldy laundry items (e.g. blankets, winter clothes, etc.) add the detergent before you add the laundry to utilize the up, down, left and right 3D 4-directional stereo wash provided by Wobble Technology™ for a better result.

5. Press the **Start/Pause** button.

## DELICATE PROGRAM

Washable sweater, cardigan, delicate clothes etc.

1. Press the **Power** button to “On”.
2. Press the **Program** select button two times
3. Press the **Start/Pause** button.  
Washing, rinsing, and spinning follow. If you want to pause, press the **Start/Pause** button again. You can change the course when paused.
4. Close the lid.



- You can only select cold water.
- The last spin operates lightly to prevent wrinkles.
- Use the detergent indicated in the laundry.

5. Press the **Start/Pause** button.

## QUICK PROGRAM

If you want to wash those frequently used towels or less dirty laundry time.

Because washing is speedy, it is good for light or less stained laundry.

1. Press the **Power** button to “On”.
2. Press the **Program** select button three times.
3. Press the **Start/Pasue** button.  
Water level is selected automatically. Washing, rinsing, and spinning follow. If you want to pause, press the **Start/Pasue** button again. You can change the program when paused.
4. Close the lid.
5. Press the **Start/Pause** button.

# setting up your washer

## SUPER CLEAN PROGRAM

---

Use for cleaner washing.

1. Press the **Power** button to “On”.
2. Press the **Program** select button four times.
3. Press the **Start/Pause** button and put the proper amount of detergent into tub.  
Water level is selected automatically.
4. Close the lid.
5. Press the **Start/Pause** button.

## WATER SAVING PROGRAM

---

This is a specifically designed course that enables you to wash laundry effectively with low amounts of water. Water Saving, Cold&Hot, Water Level 7 is recommended for a normally soiled cotton load.

1. Press the **Power** button to “On”.
2. Press the **Program** select button five times.
3. Press the **Water Level** button to display level “7”.
4. Press the **Water Supply** button to display “Cold & Hot”.
5. Press the **Start/Pause** button.  
Water level is selected automatically. Washing, rinsing, and spinning follow. If you want to pause, press the **Start/Pause** button again. You can change the course when paused.
6. Close the lid.
7. Press the **Start/Pause** button.

## TUB CLEAN PROGRAM

---

Use this program to clean the tub. It will keep the tub clean and sanitary.

1. Press the **Power** button to turn the washer “On”.
2. Press the **Program** selection button six times.
3. Press the **Start/Pause** button.
4. Add a delicated detergent and close the lid
  - Never place laundry in the tub when cleaning inside the tub, as this can cause discoloration or damage to the laundry.
  - When doing the laundry after cleaning the tub, you may find some impurities. These are just detergent residues and impurities after the tub cleaning. Perform the rinse cycle two to three times.
  - The water level is set to Mid early on and then changed to High during the rinse.
5. Press the **Start/Pause** button.

## AIR TURBO PROGRAM

---

This course saves you valuable time, ensuring that your clothes dry faster than from line drying.

1. Press the **Power** button to “On”.
2. Press the **Program** select button seven times.
3. Close the lid.
4. Press the **Start/Pause** button.
  - Select this when you want to half-dry the laundry.

## KEEPING THE TUB CLEAN

When using the machine under humid conditions for an extended time, various bacteria from the air may stick to the tub and form black dirt (fungi), causing damage to the human body.

To keep the tub clean and hygienic at all times, it is recommended detergents to clean the tub regularly at least once every one to three months.



- The Eco Tub Clean course even works without detergent.
- For this function, do not put laundry into the tub. This may cause the laundry to be damaged or the product to malfunction.
- Make sure to use only detergent for cleaning the wash tub when using detergent for this course.

## DELAY START

How to reserve washing?

Select this program when you have to go out or do something else.

1. Press the **Power** button to "On".
2. Press the **Delay Start** button once.  
You may change the delay start time with use the **Delay Start** button. (from 3 hours to 19 hours)
3. Press the **Start/Pause** button and put the proper amount of detergent into tub.
4. Close the lid.  
The washing finishes by the time you reserved. Add detergent and softener in proportion to the water level. Then, close the lid.
  - Must add the detergent in the detergent box.
  - If the detergent is spread on the laundry directly, some clothes may get discolored as the start delays.
  - If the Delay Start needs to be canceled, press the Power button.
  - The reserved finish time may be changed depends on the water pressure.
5. Press the **Start/Pause** button.

## CHILD LOCK

This function is for protecting children, the elderly and the frail.

1. Press the Power button.
2. To activate the Child Lock function, press and hold both the Rinse and Spin buttons down simultaneously for 3 seconds. (If the Child Lock function is activated, the Child Lock icon blinks.)
3. Operations after activating the Child Lock function.
  - Even if the Child Lock function is activated, every button works until the door opens.
  - When you open the door during the Child Lock is being activated, the alarm sounds and an error message appears. In 30 seconds, draining begins automatically. However, if you close the door within 30 seconds, water will not be drained. (Displayed error message "CL", "dE").
  - To add laundry after activating the Child Lock function, you must deactivate the Child Lock function.
4. To deactivate the Child Lock function, press and hold both the Rinse and Spin buttons simultaneously for 3 seconds again. (If the Child Lock function is deactivated, the Child Lock icon is turned off.)
5. To clear "CL" display, after draining is complete, close the door of the washing turn the power off and then on.



- This function is for preventing injury and malfunction of the product because of inappropriate operations or actions by children, the elderly or the frail.
- If the door opens when the Child Lock function is activated, the water is drained by force to prevent children from drowning.
- To add laundry after activating the Child Lock function, you must deactivate the Child Lock.
- Even if the power is turned off and then on when the Child Lock is activated, the Child Lock remains activated.









- Once Child Lock is activated, even when the power is turned off, if the door is opened, water is automatically drained in 30 seconds.
- The Child Lock function cannot be deactivated when CL is displayed. (However, the Child Lock function can be deactivated when the dE error is displayed.)

# manual functions

Possible to select the function for each program.

(Example) For a simple washing as the little dirt program :

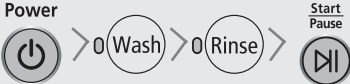
Power → Select the little dirt program → Wash → Start/Pause

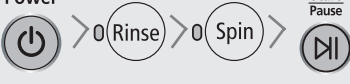
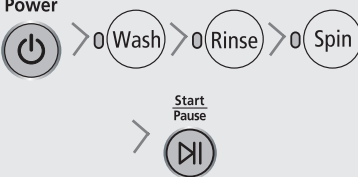
<p><b>WASH ONLY</b></p> 	<p>Press the <b>Power</b> button.            Press the <b>Wash</b> button.            Press the <b>Start/Pause</b> button.            Washing goes on for 1 time.            When the <b>Wash</b> button is pressed during washing, the wash time can be changed to between 4 and 30 minutes in duration.</p> <p> The wash time for Water Saving program is preset at 40 minutes.</p>
<p><b>RINSE ONLY</b></p> 	<p>Press the <b>Rinse</b> button.            Press the <b>Start/Pause</b> button.            Rinsing goes on for 1 times.            When the <b>Rinse</b> button is pressed, the rinse times can be changed to between 1 to 5 times in duration.</p>
<p><b>SPIN ONLY</b></p> 	<p>Press the <b>Spin</b> button.            Press the <b>Start/Pause</b> button.            Spin drying goes on for 4 minutes.            When the <b>Spin</b> button is pressed, the spin time can be changed to from 0 to 9 minutes.            If 0 minutes is selected, the cycle is terminated after a drain cycle only without the spin cycle being performed.</p>
<p><b>WASH AND RINSE</b></p> 	<p>Press the <b>Wash</b> and <b>Rinse</b> button.            Press the <b>Start/Pause</b> button once.            Detects the amount of laundry, and determines wash and rinse time period automatically.            When the <b>Wash</b> and <b>Rinse</b> button is pressed, wash time period is determined between 4 and 30 minutes, and rinse time is determined between 1 and 5 times.</p> <p> The wash time for Water Saving program is preset at 40 minutes.</p>
<p><b>RINSE AND SPIN</b></p> 	<p>Press the <b>Rinse</b> and <b>Spin</b> button.            Press the <b>Start/Pause</b> button once.            Rinsing and spin drying follow.            When the <b>Rinse</b> and <b>Spin</b> button is pressed, the number of rinse times is determined between 1 and 5, and spin time period for drying is determined between 0 and 9 minutes.</p>
<p><b>WASH, RINSE AND SPIN</b></p> 	<p>Press the <b>Wash, Rinse</b> and <b>Spin</b> button.            Press the <b>Start/Pause</b> button once.  <b>Wash, Rinse</b> and <b>Spin</b> is performed.</p>



# installation & maintenance

The User's Manual is for common use.

Make use of the User's Manual depending upon your washing machine model.

## ENVIRONMENT

### Leave some space

Maintain at least 10cm between the washer and the wall.

### Place the washer on a sturdy flat surface.

If the washer is placed on an uneven or weak surface, noise or vibration occurs. (Allowable is 1°)

### Adjust the legs for even placement.

### Never install the washer near water.

Do not place the washer in steamy rooms or where the washer is directly exposed to rain. Moisture may destroy the electrical insulation causing an electrical shock hazard.

### Avoid direct sunlight or heaters.

As plastic and electrical components are affected by direct heat, never place the washer near furnaces, boilers, etc. Do not place under direct sunlight.

## LEVELLING

- If the washer is not leveled with the ground, it makes the machine tremble more or be out of order. So, make sure that the washer is leveled properly.

### SEE IF THE MACHINE IS PLACED LEVEL BY CHECKING THE POSITION OF THE WASHING TUB.

- Open the lid of the machine, pour water into the tub up to the level just below the pulsator, and adjust the legs so that the pulsator is positioned at the center of the water as shown in the figure.
- Place the machine more than 10cm away from the wall.
- Adjust the legs on feet for levelling.

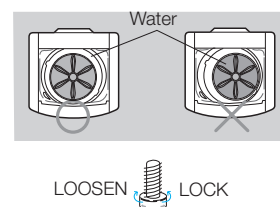

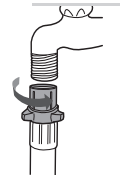

## CONNECTING THE WATER SUPPLY HOSE

1. If the water tap is a screw type, assemble a water supply hose that fits to the tap as shown. After completing connection, if water leaks from the hose, then repeat the same steps.

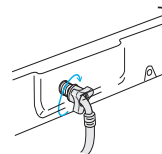

2. Connect the other end of the water supply hose to the inlet water valve at the back of the washer. Screw the hose clockwise all the way in.



-  After completing connection, if water leaks from the hose, then repeat the same steps. Use the most conventional type of faucet for water supply. In case the faucet is square or too big, remove the spacing ring before inserting the faucet into the adaptor.

# installation & maintenance

## ASSEMBLING THE RAT PROTECTION PANEL

Tilt the washer a little and lift up the panel until it clicks as shown in the figure.

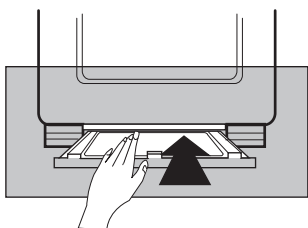

1. Insert the rat protection panel to the assembling hole on back side to the end.

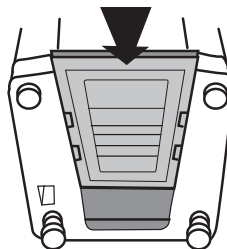

2. If you have difficulty inserting the panel lift up the washer a little and insert it.

## HOW TO CONNECT THE DRAIN HOSE

### IN CASE OF PUMP-DRAINED WASHER



Take out the cap-hose and connect the outlet-hose.

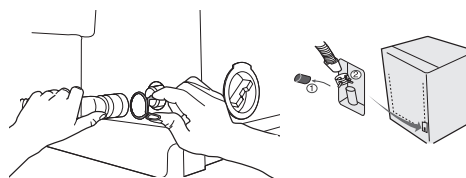

Be sure to join tightly the drain hose into the drainoutlet on the back of the machine.

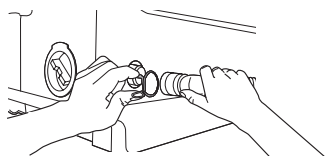

Be sure to join tightly the drain hose into the drain-outlet on the side of the machine.

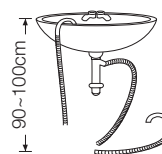

Install the drain hose in the position of about 90-100cm above the ground.







## Adjusting the height of the washer (Optional)

Make sure your washer is level by adjusting the leveling legs.

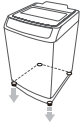

Beware of catching your hands under the legs.

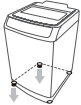
1. Pull the handles located at the right and left front of the washer and slide them off.
2. Adjust the height of the washer upwards or downwards.
3. When you have finished adjusting the height, push the handles back to fix the adjusting legs in place.

Water drop mark	Cause	How to level
 	The front of the washer is lower	Level the washer by adjusting the legs.
 	The back of the washer is lower	Adjust the height by using the props at the back.
 	The left of the washer is lower	Adjust the left side by using the adjustable legs at the front and props at the back.
 	The right of the washer is lower	Adjust the right side by using the adjustable legs at the front and props at the back.

## Leveling your washer with the leveling screws (Optional)

1. Gently lift up the washer and turn the adjustable legs to the left to find the optimal balance.

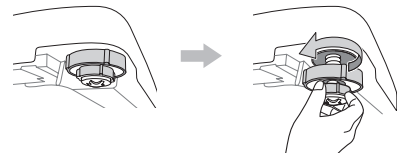

2. When done, return the washer to its original position.

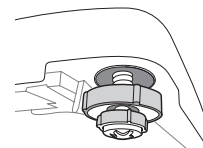

3. After adjusting the legs, do not forget to lock the nut for safety reasons. (Failing to do so may cause it to become loose and and move out of position.)

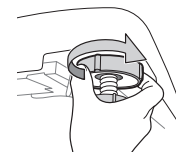

Test run

Make sure that you install your washing machine correctly by running the Rinse+Spin cycle after the installation is complete.

installation & maintenance \_19

# installation & maintenance

## ADDING DETERGENT

1. Open the detergent drawer and then add the powder detergent into the detergent compartment.
2. Add detergent evenly so that it doesn't brim over the edge of the drawer.

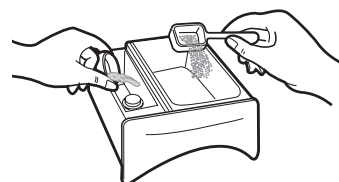

- Use a reasonable amount of detergent.  
If you use more detergent than the standard quantity or the water temperature is too low and the detergent does not dissolve in the water completely causing it to remain on the laundry and in the hose and tub, it may cause damage such as dirtying and discoloring the laundry.
- If you use a powder detergent and it remains on the laundry, it may cause a bad odor. Rinse the laundry sufficiently in fresh water.



If you spread a powder detergent over the laundry directly, it may result in discoloration. Make sure to insert it into the detergent compartment.

If the water pressure is low, the detergent may remain in the detergent compartment.

## ADDING FABRIC SOFTENER

1. When the proper amount (one time dose) of fabric softener is stored in the softener inlet, it is automatically added during the last rinse cycle.
2. Do not add detergent, bleach or starch into the softener inlet.
3. Using too much softener may produce unsatisfactory results.
4. Do not open the lid during the Spin cycle. If added too early, its effectiveness will decrease.
5. Do not leave the softener in the softener dispenser for a long time as it may congeal.



If the water pressure is low, the fabric softener may remain in the softener compartment. In this case, put the fabric softener into the tub directly.

## WATER SUPPLY CONNECTOR FILTER

1. Pull out the filter and wash well.

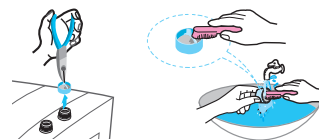

2. Pull in the filter and connect the hose to the inlet water valve tightly.



3. Check if there is a leakage.  
Note to tighten up the connector.

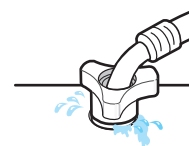

## CLEANING THE FILTER

Clean the filter net often to keep the washer clean.

1. Push the upper part of the Hygiene filter and pull in.

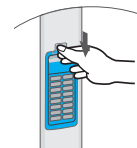

2. Open the cover as shown in the figure.

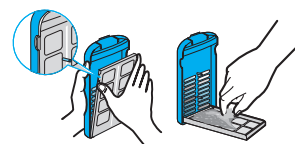

3. Clean the Hygiene filter.



4. Close the cover and insert the lower part of the filter in the basket first and then push the filter with “click” sound.



# installation & maintenance

## CLEANING THE PUMP FILTER



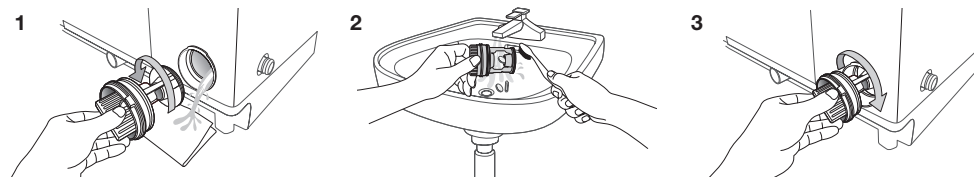



1. Place a rag or towel under the wash filter to avoid wetting the floor, and rotate the filter counterclockwise and pull it out.
2. Remove any dirt from the filter.
3. Return the filter to its place by rotating the filter clockwise until it locks into position.



## CLEANING THE DETERGENT COMPARTMENT

1. Separate the detergent compartment from the washer.
2. Separate and clean the Rinse-Cap from the detergent compartment.
3. Assemble the Rinse-Cap and insert the detergent compartment into the washer.

# troubleshooting

PROBLEM	CHECK
Washing machine won't work	<ul style="list-style-type: none"> <li>• Is the water tap opened?</li> <li>• Is the washer plugged in?</li> <li>• Is the power cut off?</li> <li>• Is there enough water?</li> </ul>
Water dose not drain 	<ul style="list-style-type: none"> <li>• Is the drain hose down?(No pump)</li> <li>• Is the drain hose frozen?</li> <li>• Is the drain hose clogged?</li> <li>• If the water dose not drain in 30 minutes, a buzzer will sound, and the remaining time indicator will show "5E".</li> </ul>
Water is not supplied 	<ul style="list-style-type: none"> <li>• Is the water tap opened?</li> <li>• Is the water cut off?</li> <li>• Is the water supply hose or hose connection clogged?</li> <li>• Is the water tap frozen?</li> <li>• If the water supply is not finished in 1 hour or there is no change in the water level 4 minutes after the water supply has started, the buzzer rings and "4E" is displayed on the remaining time indicator.</li> </ul>
Spinning does not work 	<ul style="list-style-type: none"> <li>• Is the laundry spread out evenly in the washer?</li> <li>• In the washer set on a sturdy flat surface?</li> </ul>
Water is overflowed 	<ul style="list-style-type: none"> <li>• Restart after spinning.</li> <li>• If the error sign still indicates, call agency.</li> </ul>
This indicates that a Child Lock error occurred 	<ul style="list-style-type: none"> <li>• The error message blinks at a 1 second interval and the water is drained with an alarm sound. (Displayed message: "CL" or "dE")</li> <li>• This function is to prevent children from drowning when falling into the wash tub. When draining is complete and you turn the power off and then on, the washing machine will operate normally.</li> <li>• To clear "CL" display, after draining is complete, close the door of the washing machine, turn the power off and then on.</li> </ul>
Water leakage error 	<ul style="list-style-type: none"> <li>• Check if the end of the drain hose is placed on the floor. (The hose should be hung over the pump - hose guide.)</li> <li>• Check if the drain hose is clogged by any foreign substances.</li> <li>• If the error remains, call the service center.</li> </ul>

# washing machine won't work?

PROBLEM	CHECK
The power is cut off.	Is the electric voltage normal?
	Is the washer plugged in? Plug in the electric cord. ☞ Water does not drain.
Dose not Darin	Is the drain hose down? Put the drain hose down.
	Is the drain hose folded? Unfold the drain hose.
	Is the drain hose outlet clogged? Remove the waste cleanly.
Washing machine won't work.	Is the washer lid open? ☞ Close the lid.
	Is the Pause button on? ☞ Press the Start/Pause button one more time and check if the washer starts.
	Is enough water filled to the water level? ☞ If the water pressure is low, it takes a long time to start washing.
	Is the faucet closed? ☞ Open the faucet to supply water.
If the drain hose and spin basket are frozen, do as follows.	<ul style="list-style-type: none"> <li>• Add hot water to the frozen water tap and remove the drain hose. Soak into hot water.</li> <li>• Pour hot water into the spin basket for about 10 minutes.</li> <li>• Put a hot water towel on the drain hose connector.</li> <li>• If the drain hose defrosts, connect again and check for proper water draining.</li> </ul>
The water drains out immediately.	<ul style="list-style-type: none"> <li>• The drain is clogged with coins or pins. The drain hose is hung over the drain hose hook. Half fill the spin basket with water and try for spinning again.</li> </ul>
The water leaks at the water supply hose connector.	If the faucet connecting part is loose, water may leak. ☞ Repeat the assembling steps again. (Refer to "Connecting the water supply hose")
	Check if the rubber packing of water supply hose is in the right position. ☞ Screw tightly again.
	Is the water supply hose folded? ☞ Unfold the hose.
	If the water supply is too strong, water may leak. ☞ Close the faucet a little.
	Is water leaking from the faucet itself? ☞ Fix the faucet. Water is not supplied.
	☞ Fix the faucet. Water is not supplied.
When no water is extracted.	Did you press the Start/Pause button after selecting the water supply? ☞ If the Start/Pause button is not pressed, water is not supplied. Press the Start/Pause button.
	Is the faucet closed? ☞ Turn on the faucet.
	Is the filter net at the water supply hose connector clogged with dirty matters? ☞ Clean the filter net by brushing with a toothbrush.
	Is the water supply cut off? ☞ If the water supply is suspended, turn off the faucet and power off.
	☞ If the water supply is suspended, turn off the faucet and power off.
Spinning makes loud noises and vibrations.	Check if the laundry is spread evenly in the washer. ☞ Spread out the laundry evenly and start again.
	Check if the washing machine levels on a sturdy flat floor. ☞ Set the machine at level.
	Is the handle for leveling legs loose? ☞ Adjust the legs on the feet for leveling.
	Is around the washing machine filled with unnecessary stuffs? ☞ Remove those unnecessary things away from the wash machine.
	☞ Remove those unnecessary things away from the wash machine.

24\_washing machine won't work?



# specification

## WA75G9T

MAX. MASS OF DRY CLOTH IN kg	WA75G9T	7.5 kg	STANDARD WATER LEVEL	7	74 l
POWER CONSUMPTION	WASH	510 W		5	66 l
	SPIN	300 W		3	54 l
DIMENSIONS(mm)		W602XL670XH996(HIGH BASE)		1	44 l
WEIGHT		44 kg			
WATER PRESSURE		0.05~0.78 MPa (0.5 ~ 8.0 kg.f/cm <sup>2</sup> )	WATER USAGE		156 l
WASHING TYPE		Stirring Type	SPIN SPEED		720 rpm

memo

---

memo

---



QUESTIONS OR COMMENTS?

<b>Country</b>	<b>CALL</b>	<b>OR VISIT US ONLINE AT</b>
AUSTRALIA	1300 362 603	<a href="http://www.samsung.com">www.samsung.com</a>

Code No. : DC68-02961M-02\_EN