

ozito

power
garden

3 IN 1 Vacuum Blower-Mulcher

2400W

Instruction Manual
2 Year Replacement Warranty

BLV-2401



WARNING! Read all safety warnings and all instructions. Failure to follow the warnings and instructions may result in electric shock, fire and/or serious injury.

Save all warnings and instructions for future reference.



0812

To view the full range visit: www.ozito.com.au

SPECIFICATIONS - MODEL NO. BLV-2401

Motor:	2400W
Input:	230-240V ~ 50Hz
No load speed:	10,000 - 15,000/min
Air speed:	160 - 270km/h
Max air volume:	12m ³ /min
Mulching ratio:	10:1
Collection bag size:	40 Litres
Weight:	3.4kg

KNOW YOUR PRODUCT

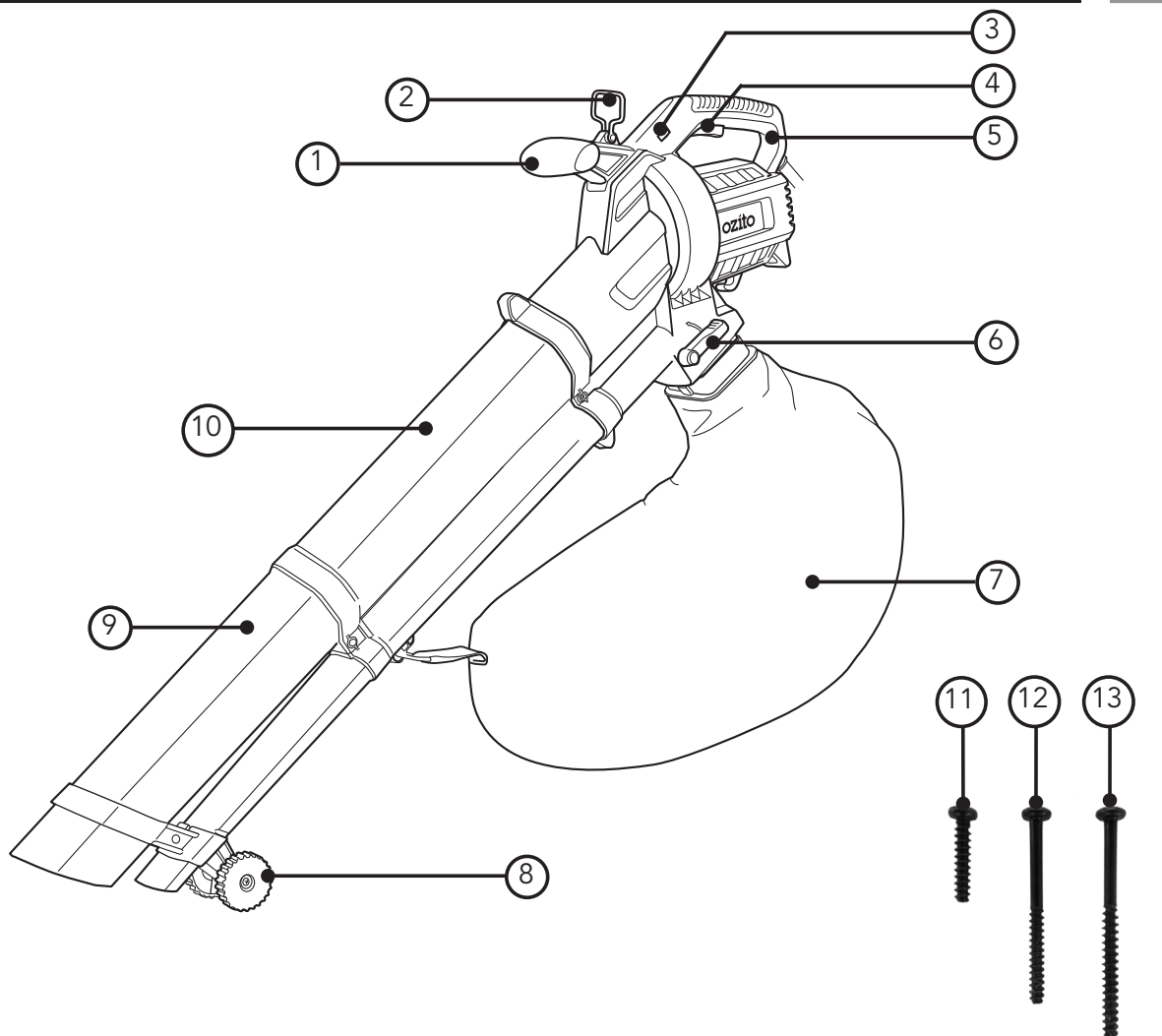

- | | | |
|------------------------|-------------------------|-------------------------|
| 1. Secondary handle | 6. Mode selection lever | 11. 20mm Assembly screw |
| 2. Shoulder strap hook | 7. Collection bag | 12. 45mm Assembly screw |
| 3. Variable speed dial | 8. Nose guide wheels | 13. 55mm Assembly screw |
| 4. On/Off switch | 9. Lower tube | |
| 5. Main handle | 10. Upper tube | |

TABLE OF CONTENTS

SPECIFICATIONS	Page 2
INTRODUCTION.....	Page 4
ELECTRICAL SAFETY.....	Page 4
GENERAL POWER TOOL SAFETY WARNINGS.....	Page 5
BLOWER VAC SAFETY WARNINGS	Page 7
ASSEMBLY.....	Page 9
OPERATION.....	Page 11
MAINTENANCE.....	Page 13
SPARE PARTS	Page 14
DESCRIPTION OF SYMBOLS	Page 14
PACK CONTENTS	Page 15
WARRANTY.....	Page 17

INTRODUCTION

Congratulations on purchasing an Ozito 3 in 1 Vacuum Blower-Mulcher. We aim to provide quality tools at an affordable price. We hope you will enjoy using this tool for many years.

Your Ozito 3 in 1 Vacuum Blower-Mulcher BLV-2401 has been designed for blowing leaves, grass clippings and other debris from courtyards, driveways, decks and footpaths. It is intended for DIY (Do It Yourself) use only. It is not built for continuous daily use in a trade or professional capacity.

ELECTRICAL SAFETY



WARNING! When using mains-powered equipment, basic safety precautions, including the following, should always be followed to reduce risk of fire, electric shock, personal injury and material damage.

Read and understand the manual prior to operating this tool.

Save these instructions and other documents supplied with this tool for future reference.

The electric motor has been designed for 230V and 240V only. Always check that the power supply corresponds to the voltage on the rating plate.

Note: The supply of 230V and 240V on Ozito tools are interchangeable for Australia and New Zealand.



This tool is double insulated in accordance with AS/NZS 60335-1; therefore no earth wire is required.

If the supply cord is damaged, it must be replaced by a qualified electrician or a power tool repairer in order to avoid a hazard.

If operating a power tool in a damp location is unavoidable use a residual current device (RCD) protected supply. Use of an RCD reduces the risk of electric shock.

Note: Double insulation does not take the place of normal safety precautions when operating this tool. The insulation system is for added protection against injury resulting from a possible electrical insulation failure within the tool.

Using an Extension Lead

Always use an approved extension lead suitable for the power input of this tool.

Before use, inspect the extension lead for signs of damage, wear and ageing.

Replace the extension lead if damaged or defective. When using an extension lead on a reel, always unwind the lead completely. Use of an extension lead not suitable for the power input of the tool or which is damaged or defective may result in a risk of fire and electric shock.



GENERAL POWER TOOL SAFETY WARNINGS



WARNING! Read all safety warnings and all instructions. Failure to follow the warnings and instructions may result in electric shock, fire and/or serious injury.

Save all warnings and instructions for future reference. The term “power tool” in all of the warnings refers to your mains-operated (corded) power tool or battery-operated (cordless) power tool.

1) Work area safety

- a) **Keep work area clean and well lit.** Cluttered or dark areas invite accidents.
- b) **Do not operate power tools in explosive atmospheres, such as in the presence of flammable liquids, gases or dust.** Power tools create sparks which may ignite the dust or fumes.
- c) **Keep children and bystanders away while operating a power tool.** Distractions can cause you to lose control.

2) Electrical safety

- a) **Power tool plugs must match the outlet. Never modify the plug in any way. Do not use any adapter plugs with earthed (grounded) power tools.** Unmodified plugs and matching outlets will reduce risk of electric shock.
- b) **Avoid body contact with earthed or grounded surfaces, such as pipes, radiators, ranges and refrigerators.** There is an increased risk of electric shock if your body is earthed or grounded.
- c) **Do not expose power tools to rain or wet conditions.** Water entering a power tool will increase the risk of electric shock.
- d) **Do not abuse the cord. Never use the cord for carrying, pulling or unplugging the power tool. Keep cord away from heat, oil, sharp edges or moving parts.** Damaged or entangled cords increase the risk of electric shock.
- e) **When operating a power tool outdoors, use an extension cord suitable for outdoor use.** Use of a cord suitable for outdoor use reduces the risk of electric shock.
- f) **If operating a power tool in a damp location is unavoidable, use a residual current device (RCD) protected supply.** Use of an RCD reduces the risk of electric shock.

3) Personal safety

- a) **Stay alert, watch what you are doing and use common sense when operating a power tool. Do not use a power tool while you are tired or under the influence of drugs, alcohol or medication.** A moment of inattention while operating power tools may result in serious personal injury.
- b) **Use personal protective equipment. Always wear eye protection.** Protective equipment such as dust mask, non-skid safety shoes, hard hat, or hearing protection used for appropriate conditions will reduce personal injuries.
- c) **Prevent unintentional starting. Ensure the switch is in the off-position before connecting to power source and/or battery pack, picking up or carrying the tool.** Carrying power tools with your finger on the switch or energising power tools that have the switch on invites accidents.



GENERAL POWER TOOL SAFETY WARNINGS

- d) **Remove any adjusting key or wrench before turning the power tool on.** A wrench or a key left attached to a rotating part of the power tool may result in personal injury.
 - e) **Do not overreach. Keep proper footing and balance at all times.** This enables better control of the power tool in unexpected situations.
 - f) **Dress properly. Do not wear loose clothing or jewellery. Keep your hair, clothing and gloves away from moving parts.** Loose clothes, jewellery or long hair can be caught in moving parts.
 - g) **If devices are provided for the connection of dust extraction and collection facilities, ensure these are connected and properly used.** Use of dust collection can reduce dust-related hazards.
- 4) Power tool use and care**
- a) **Do not force the power tool. Use the correct power tool for your application.** The correct power tool will do the job better and safer at the rate for which it was designed.
 - b) **Do not use the power tool if the switch does not turn it on and off.** Any power tool that cannot be controlled with the switch is dangerous and must be repaired.
 - c) **Disconnect the plug from the power source and/or the battery pack from the power tool before making any adjustments, changing accessories, or storing power tools.** Such preventive safety measures reduce the risk of starting the power tool accidentally.
 - d) **Store idle power tools out of the reach of children and do not allow persons unfamiliar with the power tool or these instructions to operate the power tool.** Power tools are dangerous in the hands of untrained users.
 - e) **Maintain power tools. Check for misalignment or binding of moving parts, breakage of parts and any other condition that may affect the power tool's operation. If damaged, have the power tool repaired before use.** Many accidents are caused by poorly maintained power tools.
 - f) **Keep cutting tools sharp and clean.** Properly maintained cutting tools with sharp cutting edges are less likely to bind and are easier to control.
 - g) **Use the power tool, accessories and tool bits etc. in accordance with these instructions, taking into account the working conditions and the work to be performed.** Use of the power tool for operations different from those intended could result in a hazardous situation.
- 5) Service**
- a) **Have your power tool serviced by a qualified repair person using only identical replacement parts.** This will ensure that the safety of the power tool is maintained.
 - b) **If the supply cord is damaged, it must be replaced by the manufacturer, its service agent or similarly qualified persons in order to avoid a hazard.**



BLOWER VAC SAFETY WARNINGS

It is recommended the blower vacuum be supplied via residual current device (RCD) with a tripping current not more than 30mA.

Always wear adequate protective clothing when operating the tool to avoid injuries to face, eyes, hands, feet, head or hearing. Use safety glasses or a face shield, high boots or sturdy shoes, long trousers, work gloves, a hard hat and ear defenders.

Do not start the tool when it is upside down or when it is not in the operating position.

Switch the motor off and remove the plug when the tool is not being used, left unattended, being cleaned, being moved from one place to another or when the extension cord is entangled or damaged.

Do not operate the tool near people, especially children or pets. Turn it off if they get too close. Maintain a safe distance of at least 5m from other people when using the tool.

Never direct the blower direction nozzle towards bystanders or pets. Never blow debris in the direction of bystanders or pets. The operator is responsible for accidents or hazards occurring to other people or their property.

Do not handle the plug or the tool with wet hands and do not use the tool in the rain. Use only outdoor rated extension leads that are so marked. Keep the extension cord away from heat, oil and sharp edges.

Ensure that the extension lead is secured in a manner that prevents it from disconnecting from the plug whilst in use.

Keep all the air intakes and the blower tube free of dust, lint, hair and other material that may cause a reduction in air flow.

Keep a balanced and stable stance while using the tool. Do not switch on the tool in enclosed or poorly ventilated spaces or in the presence of inflammable and/or explosive substances such as liquids, gasses and powders.

Do not get distracted and always concentrate on what you are doing. Use common sense. Never operate the tool when you are tired, sick or under the influence of alcohol or other drugs.

Do not operate this appliance with long loose hair or loose fitting jewellery. Tie long loose hair back and remove loose fitting jewellery.

Only operate the tool during broad daylight or with adequate artificial light.

When the tool is not in use, store it in a dry place and out of reach of children.

Only use the tool according to the instructions given in this manual.

Check regularly that the screws are tight.

Do not allow the blower vac to pick up any burning or smouldering materials like ashes, cigarette butts etc.

Do not attempt to pick up breakable objects like glass, plastics, china etc.

Do not use in vacuum operation without the collection bag fitted.

Do not use the blower vac in either the vacuum or the blow position on gravel surfaces.

Do not use in the rain or leave outdoors while raining.



BLOWER VAC SAFETY WARNINGS

1) Training

- Read the instructions carefully. Be familiar with the controls and the proper use of the appliance.
- Never allow children to use the appliance.
- Never allow people unfamiliar with these instructions to use the appliance. Local regulations may restrict the age of the operator.
- Never operate the appliance while people, especially children, or pets are nearby.
- The operator or user is responsible for accidents or hazards occurring to other people or their property.

2) Preparation

- While operating the appliance, always wear substantial footwear and long trousers.
- Do not wear loose clothing or jewellery that can be drawn into the air inlet. Keep long hair away from the air inlets.
- Wear protective goggles while operating
- To prevent dust irritation the wearing of a face mask is recommended
- Before using, check the supply and extension cord for signs of damage and aging.
- Do not use the appliance if the cord is damaged or worn.
- Never operate the appliance with defective guards or shields, or without safety devices, for example debris collector in place.
- Only use a weather proof extension cord fitted with a coupler according to IEC 60320-2-3.

3) Operation

- Always direct the cord to the rear away from the appliance.
- If a cord becomes damaged during use, disconnect the supply cord from the mains immediately. **DO NOT TOUCH THE CORD BEFORE DISCONNECTING THE SUPPLY.**
- Do not carry the appliance by the cord.
- Disconnect the appliance from the mains supply
 - whenever you leave the machine;
 - before clearing a blockage;
 - before checking, cleaning or working on the appliance;
 - if the appliance starts to vibrate abnormally.
- Operate the appliance only in daylight or in good artificial light.
- Do not overreach and keep your balance at all times.
- Always be sure of your footing on slopes.
- Walk, never run.
- Keep all cooling air inlets clear of debris.
- Never blow debris in the direction of bystanders.

4) Maintenance and storage

- Keep all nuts, bolts and screws tight to be sure the appliance is in safe working condition.
- Check the debris collector frequently for wear or deterioration.
- Replace worn or damaged parts.
- Use only genuine replacement parts and accessories
- Store the appliance only in a dry place.

ASSEMBLY



WARNING! Before assembly, make sure that the blower vac is switched off and unplugged..

Assembling the secondary handle (1)

1. Insert secondary handle (1) to the blower vac and push until connected firmly (Fig. 1).

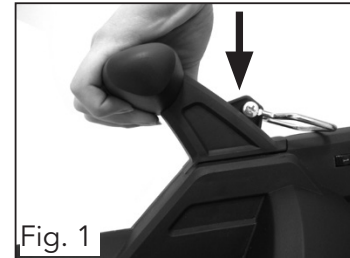

Assembling the tubes to the blower vac

1. Insert the smaller lower tube (9a) into matching upper tube (10a) and push them together until they are connected firmly (Fig. 2).



2. Insert the remaining larger lower tube (9b) into matching upper tube (10b) and push them together until they are firmly connected. Secure in place with the supplied 45mm long screw (12) (Fig. 3)

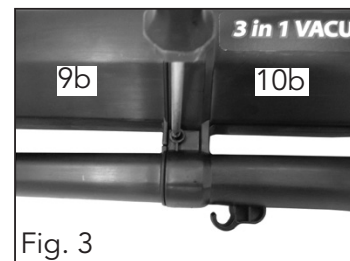

3. Slide the nose guide wheels (8) over the lower tubes (9) until it locates into position. Secure in place with the supplied 20mm long screw (11) (Fig. 4).

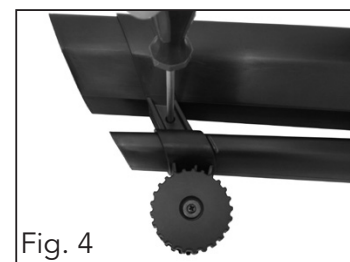

4. Slide the assembled tubes into the motor housing and secure in place with the 55mm long screw (13) supplied (Fig. 5).

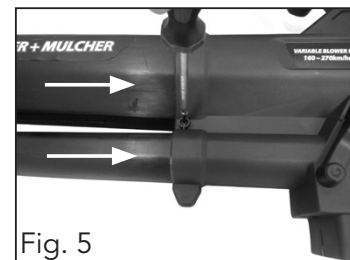

5. Check that the tubes are firmly secured to the motor housing.

Caution: In the interest of safety the tubes should not be dismantled after they have been assembled.

ASSEMBLY (CONT.)

Fitting the collection bag

Prior to fitting the collection bag (7), the lower (9) and upper (10) tubes must be fitted to the motor housing.

1. Attach the plastic connector on the collection bag (7) to the outlet in the housing, ensure that the two locating hooks "click" into the slots on the housing (Fig. 6)



2. Attach the clip on the collection bag (7) to the hook underneath the upper tube (10) (Fig. 7).



Removing the collection bag

1. Simultaneously squeeze the two locating hooks on the plastic connector and pull away from the motor housing.

Extension cord retainer (Fig. 8)

During use of the blower vac, the extension cord will continually be pulled as you move from one area to another. To avoid detaching the extension cord always check that it is attached to the cord retainer before using your blower vac.



1. Make a loop with the extension cord and push it through the square hole under the motor housing.
2. Place the end of the loop round cord retainer and ensure it is pulled firmly enough to prevent it from coming loose whilst operating the blower vac.
3. Connect the extension cord socket to the blower vac cord plug.

OPERATION

Starting the blower vac



WARNING! Ensure the lower tube (9), upper tube (10) and collection bag (7) are fitted prior to plugging in the blower vac.

1. To switch ON the blower vac press & hold the On/Off switch (4) (Fig. 9)
2. To Switch OFF the blower vac release the On/Off switch (4) again.



Important: After you have turned the blower vac Off, do not leave unattended until the blower vac has been fully disconnected from the electrical supply.

Variable speed

Variable speed provides greater control when using the blower vac, the blow speed can be adjusted depending on the application and the weight of the material being blown.

To adjust the blow speed & air volume rotate the variable speed dial (3).

The dial is numbered 1 to 6, setting to 1 provides the lowest blow speed, setting to 6 provides the fastest blow speed & air volume.

Blowing

Move the mode selection lever (6) down past the blower icon on the motor housing (Fig.10), ensuring it clicks into place.

When the blow operation is selected, air is expelled through the outlet in the lower tube.

When the blow operation is selected ensure the blower vac is pointed, directed and used in a safe manner.

Do not direct air flow from this blower vac directly or indirectly towards another person.

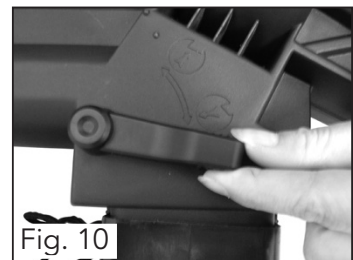

Vacuuming

Move the mode selection lever (6) upwards past the vacuum icon on the motor housing (Fig.11), ensuring it clicks into place.

When the vacuum operation is selected, air and debris is drawn up through the vacuum tube and forced through the mulching impellor. The debris is mulched and then blown down into the collection bag (7).

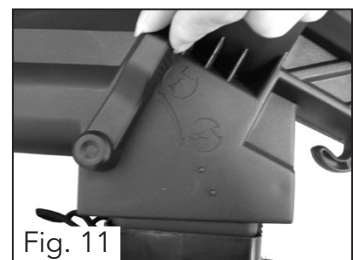

Important: Always ensure the collection bag (7) is correctly attached. Always be aware of what is being drawn up into the blower vac tube. This product is designed to vacuum garden debris including leaves, twigs and garden cuttings.

OPERATION (CONT.)

Caution: Do not force the mode selection lever (6). The lever should move with very little resistance. If the lever is difficult to move, switch Off, disconnect the power supply, remove the collection bag (7), inspect the motor housing and ensure debris, dirt or mud has not jammed the lever.

When selecting either of the operations, ensure the mode selection lever (6) is fully in one position or the other, not half way.

Emptying the collection bag (7)



WARNING! Always make sure that the blower vac is switched OFF and unplugged. Wait until the impellor has stopped before attempting to empty or remove the collection bag (7) from your blower vac.

It is not necessary in most cases to remove the collection bag (7) from the blower vac when the bag needs to be emptied. The rear of the bag is fitted with a zip,

simply open the zip and empty the contents. Ensure to close the zip prior to operating the blower vac.

Tips for using your blower vac

- If the cord becomes damaged during use disconnect the supply cord from the mains immediately. **DO NOT TOUCH THE CORD BEFORE DISCONNECTING THE SUPPLY.**
- Always try and vacuum dry leaves, cutting or general garden debris. Wet material is difficult to mulch and can cause the blower vac to clog.
- If the leaves are damp, first use the blower vac in blow mode to pile the leaves in one area. Vac and mulch the leaves when dry.
- Avoid the vac on areas where are stones or other hard objects. These objects will damage the impellor of the blower vac.
- Do not allow the blower vac to pick up soil. Soil generally contains moisture and when combined with other garden debris can clog the blower vac.
- The blower vac is not a garbage disposal unit. Do not attempt to mulch any material other than garden debris.
- For better performance and comfort, it is recommended the collection bag (7) is emptied when it becomes approximately half full. This reduces the weight and also allows the vacuum operation to perform at its highest level.
- Keep all cooling inlets clear from debris.
- Walk, Never run.

MAINTENANCE



WARNING! Always make sure that the blower vac is switched OFF and unplugged. Wait until the impellor has stopped before the blower vac is serviced, cleaned or maintenance is performed.

- There are no user serviceable parts in the blower vac; if a fault is suspected or the supply cord requires replacement, return the blower vac to a power tool repairer.
- Keep air intake clean and air vents free from debris to avoid overheating the motor.
- Do not use cleaning agents to clean the plastic parts of the blower vac. A mild detergent on a damp cloth is recommended. Water must never come into contact with the blower vac.
- If the blower vac vibrates abnormally, stop motor immediately. Abnormal vibration usually indicates a mechanical problem continued operation could lead to injury or damage.
- No lubrication is necessary as the motor is equipped with lifetime-lubrication bearings.
- Keep the ventilation vents of the blower vac clean at all times, if possible, prevent foreign matter from entering the vents.
- After each use, blow air through the blower vac housing to ensure it is free from all dust particles which may have built-up. Build up of dust particles may cause the blower vac to overheat and fail.
- If the enclosure of the blower vac requires cleaning do not use solvents but a moist soft cloth only. Never let any liquid get inside the blower vac; never immerse any part of the blower vac into liquid.
- When not in use, the blower vac should be stored in a dry, frost free location not within the reach of children.

Note: Ozito Industries will not be responsible for any damage or injuries caused by repair of the tool by an unauthorised person or mishandling or mistreatment of the tool. This tool is designed for DIY use - use in commercial or industrial environments will void the warranty.











SPARE PARTS

Limited spare parts are available subject to availability. Please contact your local Bunnings Special Orders Desk to order the required spare parts.

Most common spare parts listed below

Spare Part	Part No.
Collection Bag	SPBLV2401-27
Shoulder Strap	SPBLV2401-02
Support, Collection Bag	SPBLV2401-26

DESCRIPTION OF SYMBOLS

	Double insulated	V	Voltage
	Regulator compliance mark	Hz	Hertz
n_o	No load speed	W	Wattage
/min	Revolutions or reciprocation per minute		Warning
~	Alternating current	dB	Decibel (noise) rating
m³	Metres cubed		Disconnect from power supply when performing maintenance
	Wear eye protection		Disconnect and discontinue use should the power-cord be damaged
	Do not use in wet weather		Read operating instructions before use
	Keep by standers away		
	Keep hands out of the openings while the tool is running		
	Be aware of people around you and do not direct towards them		

CARING FOR THE ENVIRONMENT



Power tools that are no longer usable should not be disposed of with household waste but in an environmentally friendly way. Please recycle where facilities exist. Check with your local council authority for recycling advice.



Recycling packaging reduces the need for landfill and raw materials. Reuse of recycled material decreases pollution in the environment. Please recycle packaging where facilities exist. Check with your local council authority for recycling advice.

CONTENTS

1 x Blower Vac BLV-2401
3 x Blower Tubes
3 x Screws
1 x Secondary Handle

1 x Shoulder Strap
1 x Collection Bag
1 x Instruction Manual

OZITO INDUSTRIES PTY LTD

AUSTRALIA (Head Office)

1 - 23 Letcon Drive, Bangholme, Victoria, Australia 3175

Telephone: 1800 069 486

Facsimile: +61 3 9238 5588

Website: www.ozito.com.au

Email: enquiries@ozito.com.au

WARRANTY

YOUR WARRANTY FORM SHOULD BE RETAINED BY YOU AT ALL TIMES. IN ORDER TO MAKE A CLAIM UNDER THIS WARRANTY YOU MUST RETURN THE PRODUCT TO YOUR NEAREST BUNNINGS WAREHOUSE WITH YOUR BUNNINGS REGISTER RECEIPT. PRIOR TO RETURNING YOUR PRODUCT FOR WARRANTY PLEASE TELEPHONE OUR CUSTOMER SERVICE HELPLINE:

Australia 1800 069 486
New Zealand 0508 069 486

TO ENSURE A SPEEDY RESPONSE PLEASE HAVE THE MODEL NUMBER AND DATE OF PURCHASE AVAILABLE. A CUSTOMER SERVICE REPRESENTATIVE WILL TAKE YOUR CALL AND ANSWER ANY QUESTIONS YOU MAY HAVE RELATING TO THE WARRANTY POLICY OR PROCEDURE.

The benefits provided under this warranty are in addition to other rights and remedies which are available to you at law.

Our goods come with guarantees that cannot be excluded at law. You are entitled to a replacement or refund for a major failure and for compensation for any other reasonably foreseeable loss or damage. You are also entitled to have the goods repaired or replaced if the goods fail to be of acceptable quality and the failure does not amount to a major failure.

Generally you will be responsible for all costs associated with a claim under this warranty, however, where you have suffered any additional direct loss as a result of a defective product you may be able to claim such expenses by contacting our customer service helpline above.

2 YEAR REPLACEMENT WARRANTY

Your product is guaranteed for a period of 24 months from the original date of purchase and is intended for DIY (Do It Yourself) use only. If a product is defective it will be replaced in accordance with the terms of this warranty. Warranty excludes consumable parts, for example: blower tube, carbon brushes, collection bag, shoulder strap.

WARNING

The following actions will result in the warranty being void.

- Professional, Industrial or high frequency use.
- If the tool has been operated on a supply voltage other than that specified on the tool.
- If the tool shows signs of damage or defects caused by or resulting from abuse, accidents or alterations.
- Failure to perform maintenance as set out within the instruction manual.
- If the tool is disassembled or tampered with in any way.

OZITO

Australia/New Zealand (Head Office)

1-23 Latcon Drive, Bangholme, Victoria, Australia 3175