



# CONTENTS

4	CONDITIONS OF USE
5	SAFETY INFORMATION
7	ENVIRONMENT CONCERNS
8	PRODUCT DESCRIPTION
9	ACCESSORIES
11	CONTROL PANEL
13	BEFORE FIRST USE
13	PROGRAMMES
14	USING THE APPLIANCE
18	HINTS AND TIPS
20	CARE AND CLEANING
26	TROUBLESHOOTING
28	TECHNICAL INFORMATION
29	INSTALLATION

## SERVICE

When contacting Service, ensure that you have the following data available. The information can be found on the rating plate.

Model \_\_\_\_\_

PNC \_\_\_\_\_

Serial Number \_\_\_\_\_

The following symbols are used in this user manual:



Warning - Important Safety information.



General information and tips



Environmental information

Subject to change without notice

## FOR PERFECT RESULTS

Thank you for choosing this AEG product. We have created it to give you impeccable performance for many years, with innovative technologies that help make life simpler – features you might not find on ordinary appliances. Please spend a few minutes reading to get the very best from it.

## ACCESSORIES AND CONSUMABLES

In the AEG webshop, you'll find everything you need to keep all your AEG appliances looking spotless and working perfectly. Along with a wide range of accessories designed and built to the high quality standards you would expect, from specialist cookware to cutlery baskets, from bottle holders to delicate laundry bags...



Visit the webshop at:  
[www.aeg.com/shop](http://www.aeg.com/shop)

## VISIT OUR WEBSITE FOR:

- Products
- Brochures
- User manuals
- Trouble shooter
- Service information

[www.aeg.com](http://www.aeg.com)

## CONDITIONS OF USE

This appliance is intended to be used in household and similar applications such as:

- Farm Houses

- By clients in serviced apartments, holiday apartments and other residential type environments



## SAFETY INFORMATION

**In the interest of your safety and to ensure the correct use, before installing and first using the appliance, read this user manual carefully, including its hints and warnings. To avoid unnecessary mistakes and accidents, it is important to ensure that all people using the appliance are thoroughly familiar with its operation and safety features. Save these instructions and make sure that they remain with the appliance if it is moved or sold, so that everyone using it through its life will be properly informed on appliance use and safety.**



— Read the instruction manual before the appliance use.



— Caution, risk of fire

### GENERAL SAFETY

- It is dangerous to alter the specifications or attempt to modify this product in any way.
- This appliance is not intended for use by persons (including children) with reduced physical, sensory or mental capabilities, or lack of experience and knowledge, unless they have been given supervision or instruction concerning use of the appliance by a person responsible for their safety.
- Make sure that small children and pets do not climb inside the drum. To avoid this, please check into the drum before using.
- Any objects such as coins, safety pins, nails, screws, stones or any other hard, sharp material can cause extensive damage and must not be placed into the machine.
- Items such as foam rubber (latex foam), shower caps, waterproof textiles (if there is no special drying programme), rubber backed articles and clothes or pillows fitted with foam rubber pads must not be dried in the tumble dryer.
- Make sure that there is access to the mains plug after the installation.
- Always unplug the appliance after use, cleaning and maintenance.
- Under no circumstances should you attempt to repair the machine yourself. Repairs carried out by inexperienced persons may cause injury or serious malfunctioning. Contact your local Service Centre. Always insist on genuine spare parts.
- Items that have been soiled with substances such as cooking oil, acetone, petrol, kerosene, spot removers, turpentine, waxes and wax removers should be washed in hot water with an extra amount of detergent before being dried in the tumble dryer.
- **Danger of explosion:** Never tumble dry items that have been in contact with inflammable solvents (petrol, methylated spirits, dry cleaning fluid and the like). As these substances are volatile, they could cause an explosion. Only tumble dry items washed with water.
- **Risk of fire:** items that have been spotted or soaked with vegetable or cooking oil constitute a fire hazard and should not be placed in the tumble dryer.
- If you have washed your laundry with stain remover you must execute an extra rinse cycle before loading your tumble dryer.
- Please make sure that no gas lighters or matches have accidentally been left in pockets of garments in case they are loaded into the appliance
- The condensed water is not suitable to drink or to prepare food. It can cause health problems to people and pets.
- Do not sit or lean on the load door. The appliance can tilt.



### WARNING!

- **Risk of fire! To prevent from the risk of self combustion do not stop a tumble dryer before the end of the drying cycle unless all items are quickly removed and spread out so that the heat is dissipated.**
- **Lint must not be allowed to accumulate around the tumble dryer.**
- **Risk of electric shock!** Do not spray down the appliance with jets of water.
- The final part of a tumble dryer cycle occurs without heat ( cool down cycle ) to ensure that the items are left at a temperature that ensures that items will not be damaged.
- The tumble dryer is not to be used if industrial chemicals have been used for cleaning.
- Ensure you have good ventilation in the installation room to avoid the back flow of gases into the room from appliances burning other fuels, including open fires.
- Oil-affected items can ignite spontaneously, especially when exposed to heat sources such as in a tumble dryer. The items become warm, causing an oxidation reaction in the oil. Oxidation creates heat. If the heat cannot escape, the items can become hot enough to catch fire. Piling, stacking or storing oil-affected items can prevent heat from escaping and so create a fire hazard.
- If it is unavoidable that fabrics that contain vegetable or cooking oil or have been contaminated by hair care products be placed in a tumble dryer they should first be washed in hot water with extra detergent - this will reduce, but not eliminate, the hazard.
- When unpacking the appliance, check that it is not damaged. If in doubt, do not use it and contact the Service Centre.
- All packaging must be removed before use. Dangerous damage can occur to the product and to property if this is not adhered to. See relevant section in the user manual.
- Any electrical work necessary to install this appliance must be done by a qualified electrician or competent person.
- The rear surface of the appliance must be put against the wall
- If the appliance is installed on the carpet or equivalent, adjust the feet. Air must flow freely below the appliance.
- After the appliance installation, check that the electrical supply cord is not caught under or behind the dryer.
- If the tumble dryer is put on top of a washing machine, it is mandatory to use the stacking kit (optional accessory - see chapter: "ACCESSORIES").

## USE

- This appliance is for domestic use only. It must not be used for other functions .
- Only dry fabrics which are applicable to dry in the tumble dryer. Follow the instructions on each piece of clothing label.
- Do not dry unwashed items in the tumble dryer.
- Do not put more load than recommended. Obey the maximum load volume. See the related chapter in the user manual.
- Clothes which are dripping wet must not be put in the tumble dryer.
- Garments which have been in contact with volatile petroleum products should not be machine dried. If volatile cleaning fluids are used, care should be taken to ensure that the fluid is removed from the garment before placing in the appliance.

## INSTALLATION

- This appliance is heavy. Be careful when you move the appliance.

- Do not use the tumble dryer if the power supply cable, the control panel, the working surface or the base are damaged so that the inside of the tumble dryer is accessible.
- Fabric softener or equivalent products must be used as specified by the fabric softener manufacturer.
- Risk of fire! Do not dry damaged items which contain padding or fillings (pillows, jackets, duvets, etc.). The padding or fillings can be exposed and cause a fire.

## CHILD SAFETY

- This machine is not intended for use by young children or infirm persons without supervision.
- Children often do not recognise the hazards associated with electrical appliances. Children should be supervised to ensure that they do not play with the appliance.



## ENVIRONMENT CONCERNS

### PACKAGING MATERIALS

Recycle the materials with the symbol . Put the packaging in applicable containers to recycle it.

The symbol  on the product or on its packaging indicates that this product may not be treated as household waste. Instead it should be taken to the appropriate collection point for the recycling of electrical and electronic



### WARNING!

- Danger of suffocation! The packaging components (e.g. plastic film, polystyrene) can be dangerous to children - Keep them out of children's reach.
- Keep all detergents in a safe place out of children's reach.
- Make sure that children or pets do not climb inside the drum.

## DISCARD THE APPLIANCE

- Disconnect the mains plug from the mains socket.
- Cut off the mains cable and discard it.
- Discard the door catch. This prevents children or pets to be closed in the appliance. There is a risk of suffocation.

equipment. By ensuring this product is disposed of correctly, you will help prevent potential negative consequences for the environment and human health, which could otherwise be caused by inappropriate waste handling of this product. For more detailed information about recycling of this product, please contact your local council, your household waste disposal service or the shop where you purchased the product.

# PRODUCT DESCRIPTION

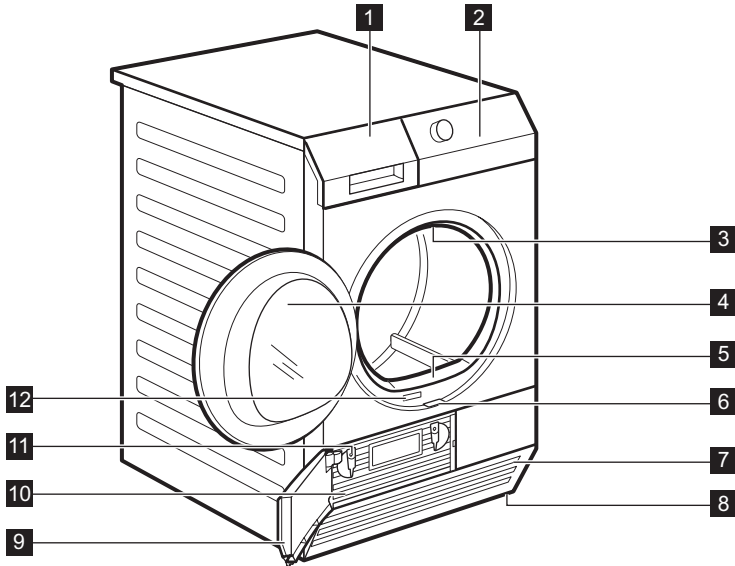

- |          |   |           |                 |
|----------|---|-----------|-----------------|
| <b>1</b> | Water container                           | <b>7</b>  | Airflow slots   |
| <b>2</b> | Control panel                             | <b>8</b>  | Adjustable feet |
| <b>3</b> | Drum light                                | <b>9</b>  | Condenser door  |
| <b>4</b> | Load door (reversible)                    | <b>10</b> | Condenser cover |
| <b>5</b> | Filter                                    | <b>11</b> | Lock knobs      |
| <b>6</b> | Sliding button to open the condenser door | <b>12</b> | Rating plate    |



## ACCESSORIES

### STACKING KIT

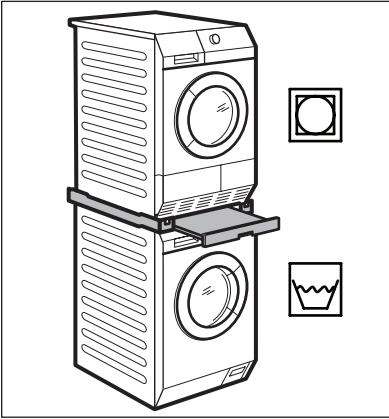

Product name: SKP11  
 Available from your authorized dealer.  
 Stacking kit can be used only with the washing machines specified in the leaflet. See leaflet attached.  
 Read carefully the instructions supplied with the kit.

### DRAINING KIT

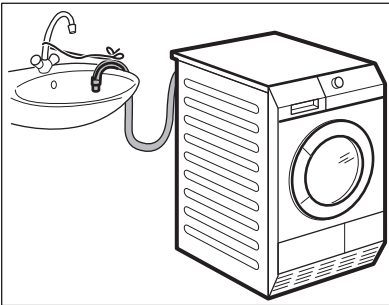

Product name: DK11.  
 Available from your authorized dealer  
 Installation kit for draining of the condensed water into a basin, siphon, gully, etc. After installation the water container is drained automatically. The water container must stay in the appliance. Installed hose must be a minimum of 50cm to a maximum of 1 m from floor level. The hose cannot be in loop. If possible decrease the length of the hose.

Read carefully the instructions supplied with the kit.

### PEDESTAL WITH THE DRAWER

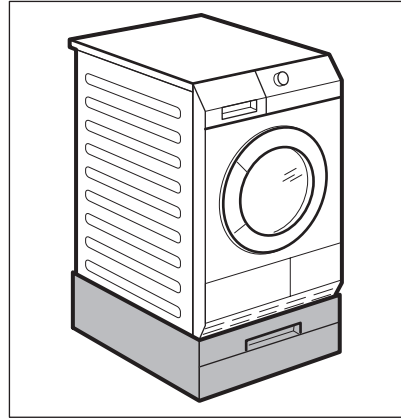

Product name: PDSTP10.  
 Available from your authorized dealer.  
 To put the appliance higher at the level which helps to easy load and remove the laundry.  
 The drawer can be use for laundry storage e.g. : towels, cleaning products and more.  
 Read carefully the instructions supplied with the accessory.

### DRYING RACK

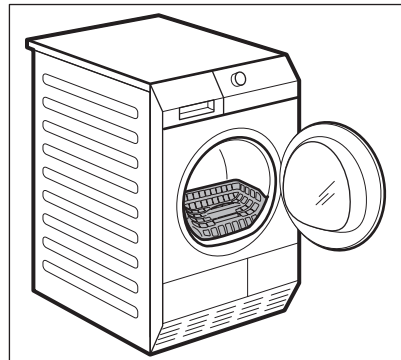

Available from your authorized dealer  
 (can be attached to some types of tumble dryers)

Drying rack accessory can be used to dry the following items safely:

- sport shoes
- wool

- soft toys

- lingerie

Read carefully the instructions supplied with the kit.

# CONTROL PANEL

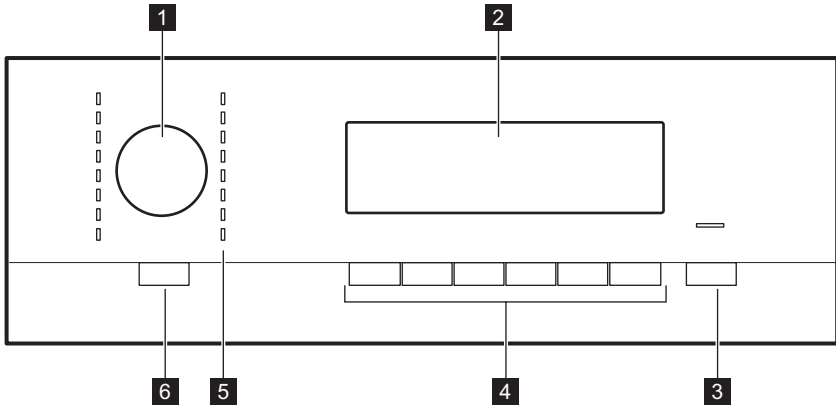



- 1** Programme dial
- 2** Display
- 3** Push button Start/Pause
- 4** The function push buttons
- 5** Programme indicators
- 6** Push button On/Off ① with Auto Off function

## DISPLAY



Symbol	Description
	extra dryness level: minimum, moderate, maximum
	delicacy level: default, moderate, maximum
	anti-crease time: default, interval (30 min. - 120 min.)
	buzzer activated
	child lock activated
	time drying function activated
	drain the water container indicator
	clean the filter indicator
	clean the condenser indicator
	drying cycle phase indicator











Symbol	Description
	cooling cycle phase indicator
	crease guard cycle phase indicator
	delay start activated
2.00	cycle time
10' - 2.00	time programme interval (10 min. - 2h.)
30' - 20h	delay start interval (30 min. - 20h.)













## BEFORE FIRST USE

Clean the tumble dryer drum with a moist cloth or set a short programme

(e.g. 30 minutes time programme) with the load of moist cloths.

## PROGRAMMES

Programmes	Load 1)	Properties	Available functions	Fabric mark
Cottons				
Extra Dry	8 kg	To dry cotton clothing. Drying level: extra dry.	all except Time Drying	
Cupboard Dry	8 kg	To dry cotton clothing. Drying level: cupboard dry.	all except Time Drying	
Iron Dry	8 kg	To dry cotton clothing. Drying level: applicable to iron.	all except Time Drying	
Extra Silent	8 kg	To gently dry cotton clothing with the noise decreased to the minimum. The programme can be used at night.	all except Time Drying 2)	
Bed Linen				
Bed Linen	3 kg	To dry bed linen such as: single and double sheet, pillowcase, bedspread.	all except Time Drying	
Duvets	3 kg	To dry single or double duvet and pillows (with feather, down or synthetic fillings).	all except Time Drying and Anti-crease 2)	
Time	8 kg	To dry laundry with the time set by the user. The time value must be related to the load. To dry one item or small quantities of the laundry we recommend to use short times.	all except Dry Plus	
Extra Quick Mixed	3 kg	To dry cotton and synthetic fabrics, uses low temperature.	all except: Delicate and Time Drying	
Synthetics				
Extra Dry	3,5 kg	To dry thick or multi-layered fabrics, e. g. pullovers, bedding, table linen.	all except Time Drying	
Cupboard Dry	3,5 kg	To dry thin fabrics which are not ironed, e.g. easy care shirts, table linen, baby clothes, socks, lingerie with bones or wires.	all except Time Drying	

Pro-grammes	Load 1)	Properties	Available functions	Fabric mark
Iron Dry	3,5 kg	To dry thin fabrics which are also to be ironed, e.g. knitwear, shirts.	all except Time Drying	  
Extra Silent	3,5 kg	To gently dry synthetic clothing with the noise decreased to the minimum. The programme can be used at night.	all except Time Drying 2)	  
Easy Iron	1 kg (or 5 shirts)	To dry easy care fabrics such as shirts and blouses; for minimum ironing effort. The results can vary for different types of fabric and its finish. Put fabrics in the tumble dryer straight away. After the cycle, immediately remove dried fabrics and put on a clothes hanger.	all except Time Drying 2)	  
Active Wear	2 kg	To dry outdoor clothing, sports, pile fabrics, waterproof and breathable jackets, jacket teamed with a removable fleece or inner insulation.	all except Time Drying and Anti-crease 2)	
Delicates	3 kg	To dry delicate fabrics.	all except Time Drying 2)	  
Wool 	1 kg	To dry the clothes made of wool . The clothes become soft and cosy. We recommend to remove the clothes immediately after the programme end.	Dry Plus , Buzzer , Time Drying 3), Delay Start 2)	

1) maximum weight of dry clothes

2) Delicate activated by default



3) Only with the drying rack — see chapter ACCESSORIES



## USING THE APPLIANCE

### PREPARING THE LAUNDRY



Dry only the laundry applicable to dry in this tumble dryer. Make sure the laundry is able to be dried in this tumble dryer. Check the fabric mark on the clothing.

Fabric mark	Property
	Applicable to dry in the tumble dryer
	Applicable to dry in the tumble dryer at standard temperature

Fabric mark	Property
	Applicable to dry in the tumble dryer at decreased temperature
	Not applicable to dry in the tumble dryer

How to correctly prepare the laundry:

- close zips, button up duvet covers and attach loose ties or ribbons (e.g. ribbons of aprons) - laundry can tangle
- make sure the pockets are empty - remove metal items (paper clips, safety pins, etc.).
- turn items with 2 fabric layers inside out (e.g. cotton lined anoraks, the cotton fabric layer must be external).

Dry only:

- cotton and linen with Cottons programmes
- synthetic and mixtures with Synthetic programmes
- separate strong coloured items from light coloured items as colours may bleed.
- make sure to use the appropriate programs with cotton jersey and knitwear as items may shrink



Do not put more laundry than the maximum load which is **8kg**.

## LOADING THE LAUNDRY

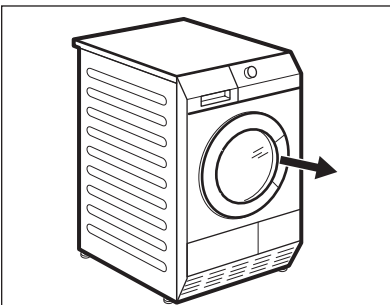

1. Pull the appliance door open
2. Load laundry loosely
3. Close the appliance door.



### CAUTION!

Do not lock the laundry in between the appliance door and rubber seal.

## SWITCHING ON THE APPLIANCE

Push the *On/Off*  button to activate or to deactivate the appliance. When the appliance is on, some indications come in to the view on the display.

## AUTO OFF FUNCTION

To decrease the energy consumption, the Auto Off function deactivates automatically the appliance:

- if the Start/Pause button was not pushed in the time of 5 minutes.
- after 5 minutes from the programme end.

Push the Auto Off button to activate the appliance.

## SETTING A PROGRAMME

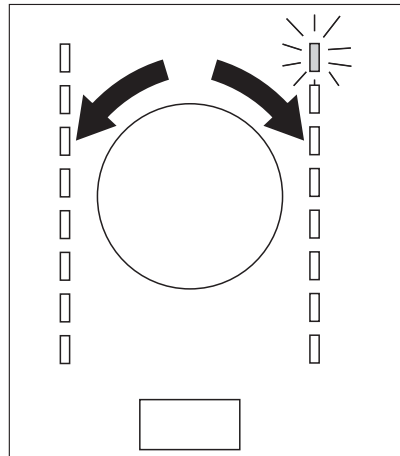

Use the programme dial to set the programme. The possible time to complete the program will be shown on the display.



The drying time you see is related to the load of 5 kg for cotton and jeans programmes. For the other programmes the drying time is related to the recommended loads. The drying time of the cotton and jeans programmes with the load more than 5 kg is longer.

## SPECIAL FUNCTIONS

Together with the programme you can set 1 or more special functions.

To activate or deactivate the function push the applicable push button.

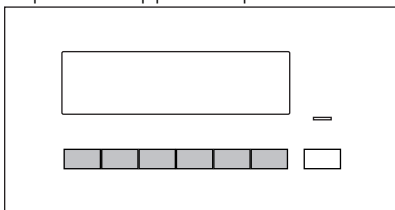

When the function is activated the applicable symbol will be shown on the display.

## THE DRY PLUS FUNCTION

This function helps achieve dryer laundry. There are 3 possible selections: minimum — the default selection which is related to the programme. moderate — to get a moderate dryness of laundry maximum — choose this selection to get maximum dryness of clothes.

## THE DELICATE FUNCTION

To dry more lightly, delicate and temperature sensitive textiles (e.g. acrylic, viscose). For fabrics with the symbol  operates with decreased heat.

## THE ANTICREASE FUNCTION

Extends anticrease phase (30 minutes) at the end of the drying cycle to 90 minutes. This function prevents laundry from creases. Laundry can be removed during the anticrease phase.

## THE BUZZER FUNCTION

When the buzzer function is activated you can hear the buzzer at the:

- cycle end
- anti-crease phase start and end
- cycle interruption

The buzzer function is by default always on. You can use this function to activate or deactivate the sound.

## THE TIME DRYING FUNCTION

Operates only with the Time programme. Lets the user set specific drying programs from 10 minutes to 2 hours in 10 minute incremental steps.

## THE DELAY START FUNCTION



Allows the delay of drying programs from a minimum of 30 minutes to a maximum of 20 hours.

1. Set the drying programme and functions.
2. Push the Delay start button repeatedly until the required time is shown on the display (e.g.  if the programme has to start after 12 hours.)
3. To activate the Delay start function, push the Start/Pause button. The time to start decreases on the display.

## CHILD LOCK FUNCTION

The child lock can be set to prevent children accidentally setting a program. The child lock function locks all push buttons and the programme dial (this function does not lock Auto/Off button). To activate the child lock function push the Dry Plus and Delicate buttons at the same time until the symbol  comes into view on the display. To deactivate push again the above buttons until the symbol goes out of view. You can activate the child lock function:

- before you push the Start/Pause button - the appliance cannot start



- after you push the Start/Pause button - all the push buttons and the programme dial are deactivated

## STARTING A PROGRAMME

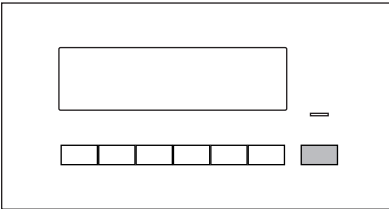

To activate the programme push the button as on the illustration. The LED above the button illuminates in red colour.

## CHANGE A PROGRAMME

To change a programme, push the Ⓛ On/Off button to deactivate appliance. Push the Ⓛ On/Off to activate the ap-

pliance and then set the programme again.

## AT THE END OF PROGRAMME

When the drying cycle is completed, the  symbol flashes on the display. If the Buzzer function is on, an acoustic signal sounds intermittently for one minute.

To remove the laundry:

1. Push the Auto/Off button for 2 seconds to deactivate the appliance.
2. Open the appliance door.
3. Remove the laundry.
4. Close the appliance door.



After each drying cycle:

- clean the filter
- drain the water container  
(See chapter *CARE AND CLEANING*.)

## HINTS AND TIPS

### ECOLOGICAL HINTS

- Do not use fabric softener to wash and then dry. In the tumble dryer laundry becomes soft automatically.
- Use the condensate as distilled water, e.g. for steam ironing. If necessary clean the condensate before (e.g. with a coffee filter) to remove possible small pieces of fluff.
- Always keep the airflow slots on the bottom of the appliance clear.
- Use the load volumes specified in the programmes chapter.
- Make sure there is good air flow in and around the appliance position.
- Clean the filter after each drying cycle.
- Ensure clothes are spun well in the washing machine before putting them in the dryer.

### AVERAGE LAUNDRY WEIGHTS



bathrobe	1200 g
quilt cover	700 g
man's work shirt	600 g
man's pyjamas	500 g
sheet	500 g
tablecloth	250 g
man's shirt	200 g
night dress	200 g
pillow case	200 g
towelling towel	200 g
blouse	100 g
ladies' briefs	100 g
men's underpants	100 g
napkin	100 g
tea towel	100 g

### WATER HARDNESS AND CONDUCTIVITY

Water hardness can be different for different locations. Water hardness has an effect on the water conductivity and the operation of the conductivity sensor in the appliance. If you know the value of the water conductivity you can adjust the sensor to dry with the better results. To change the sensor conductivity:

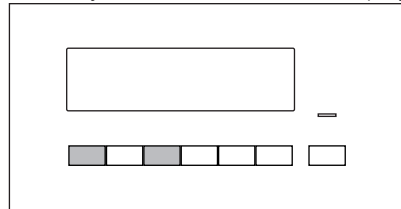
1. Turn the programme dial to available programme.
2. Push the 2 buttons shown below (see illustration) until one of the symbols is shown on the display:



-  low conductivity <300  $\mu\text{S}/\text{cm}$
-  moderate conductivity 300-600  $\mu\text{S}/\text{cm}$
-  high conductivity >600  $\mu\text{S}/\text{cm}$

3. Push the button repeatedly until the required conductivity is shown.

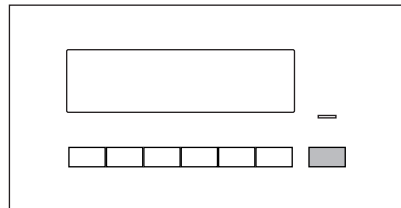

4. To memorise this setting push the same two buttons as specified in point 2.

### WATER CONTAINER FULL — INDICATION





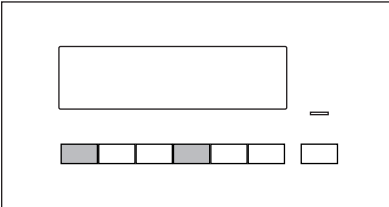

By default the indication  is always on. It comes into the view at the end of

the cycle or when the water container is full. When you use an external equipment to drain the container, the indication can be off.

To activate or deactivate the indication:

1. Turn the programme dial to available programme.
2. Push the two buttons shown below at the same time until you see the correct setting:



- the indication  is off and the indicator  comes into the view — the indication  is permanently off
- the indication  is on and the indicator  comes into the view — the indication  is activated

## CARE AND CLEANING

### CLEANING THE FILTER

At the end of each cycle the indicator  (clean the filter) is on to tell you that the filter must be cleaned.



The filter collects the fluff. The fluff occurs while the clothes are dried in the tumble dryer.

To clean the filter:

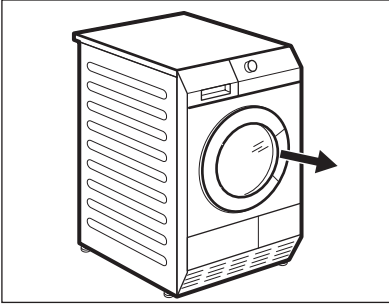

1. Open the door.

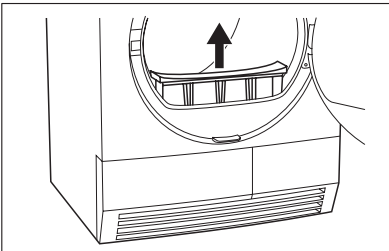

2. pull the filter up.

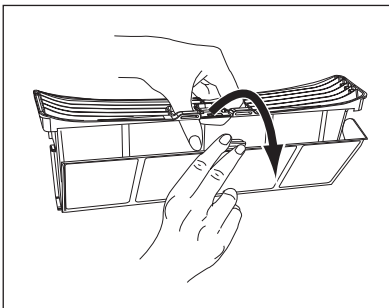

3. Open the filter.

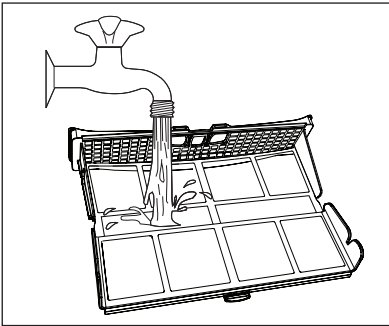
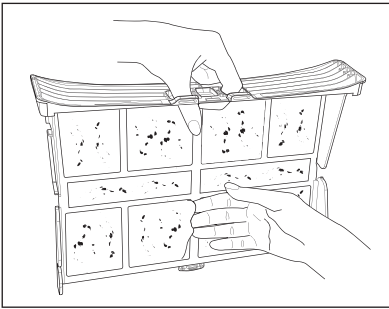

4. Use a moist hand to clean the filter.
  
5. If necessary clean the filter with warm water using a brush. Close the filter.
  
6. Remove fluff from the filter socket. For this a vacuum cleaner can be used.
  
7. Put the filter inside the filter socket.

**CAUTION!**

Do not operate the tumble dryer without the filter or with a damaged or blocked filter.



Clean the filter after each drying cycle. A clogged filter increases the cycle time and causes higher energy consumption.

## DRAINING THE WATER CONTAINER

Drain the water container after each drying cycle.

If the water container is full, the programme breaks off automatically and the indicator  *drain the water container* is on. To continue the programme, drain the water container and press the start button.



To drain the water container automatically you can install draining accessory (see chapter: *ACCESSORIES*)

To drain the water container:

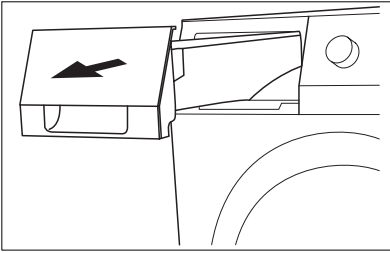

1. Pull the water container.

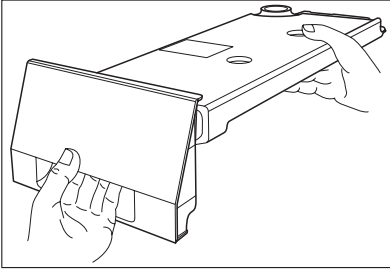

2. Move the water container in a horizontal position. Water will flow out the top opening if not kept horizontal.

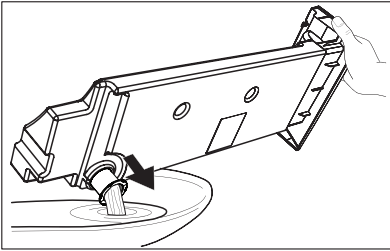

3. Move the plastic connection out and drain the water container into a sink or equivalent receptacle.

4. Move plastic connection in and install water container.



**WARNING!**

Risk of poisoning. The condensed water is not applicable to drink or to prepare food.



The condensed water can be used as distilled water, e.g. for steam ironing. If necessary filter the condensed water (e.g. with a coffee filter) to remove possible residue and small pieces of fluff.

**CLEANING THE CONDENSER**

If the indicator  *clean the condenser* is on, the condenser must be cleaned.

To clean the condenser:

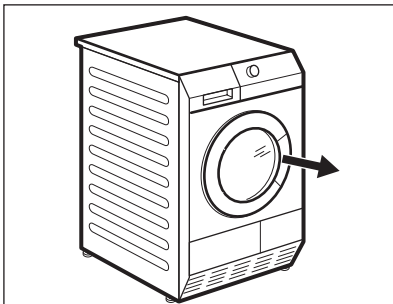

1. Open the loading door.

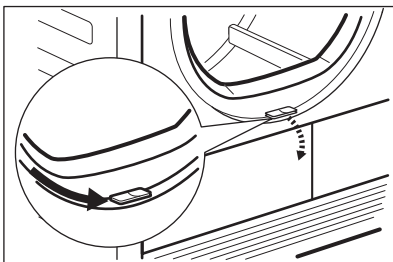

2. Move the release button on the bottom of the door opening and open the condenser door.

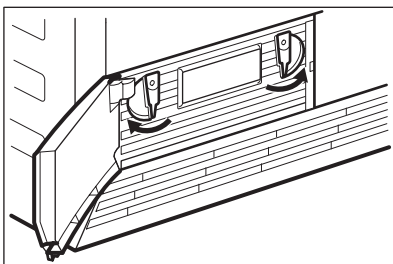

3. Turn the 2 locks to unlock the condenser lid.

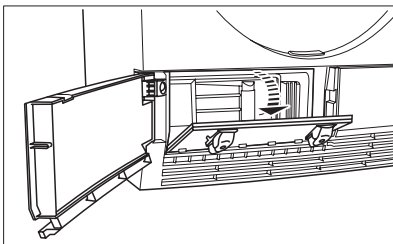

4. Lower the condenser lid.

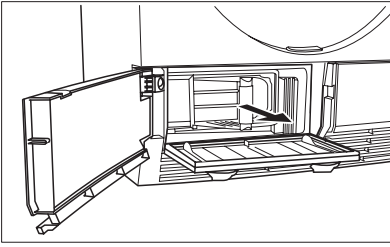

5. Catch the handle and pull the condenser out from the bottom compartment. Move condenser horizontally to prevent remaining water spilling.

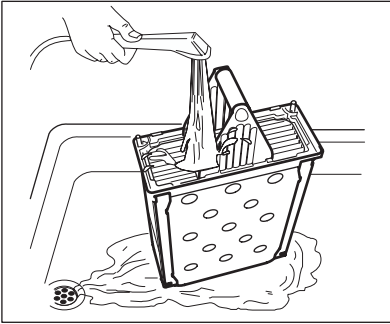

6. Clean the condenser in vertical position over a basin. Rinse through with a hand shower.

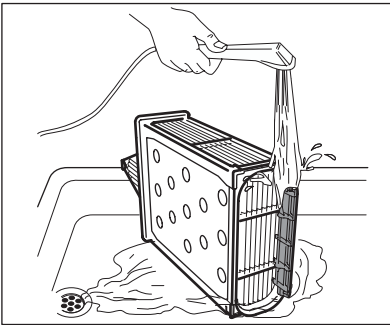

7. Clean the condenser filter. Rinse through with a hand shower.

8. Put the condenser back inside the bottom compartment.
  9. Close the condenser lid.
  10. Lock the 2 locks until they snap.
  11. Close the condenser door.
-



**CAUTION!**

Do not operate the tumble dryer when the condenser is blocked with fluff. This could cause damage. This also increases energy consumption. Do not use sharp objects to clean the condenser. The damaged condenser could cause leaks. Do not operate the tumble dryer without the condenser.

**CLEANING THE DRUM****WARNING!**

Disconnect the appliance before you clean it.

Use a standard neutral soap detergent to clean the inner surface of the drum

and drum ribs. Dry the cleaned surfaces with a soft cloth.

**CAUTION!**

Do not use abrasive materials or steel wool to clean the drum.

**CLEANING THE CONTROL PANEL AND HOUSING**

Use a standard soap detergent to clean the control panel and housing. Use a moist cloth to clean. Dry the cleaned surfaces with a soft cloth.

**CAUTION!**

Do not use furniture cleaning agents or cleaning agents which can cause corrosion to clean the appliance.

## TROUBLESHOOTING

## TROUBLESHOOTING

Problem <sup>1)</sup>	Possible cause	Remedy
The tumble dryer does not operate.	The tumble dryer is not connected to mains supply.	Connect in at mains socket. Check fuse in fuse box (domestic installation).
	The loading door is opened.	Close the loading door.
	The Auto/Off button was not pushed.	Push the Auto/Off button.
	The Start/Pause button was not pushed.	Push the Start/Pause button.
	The appliance is in the standby mode.	Push the Auto/Off button.
Unsatisfactory drying results.	Incorrect programme selection.	Select applicable programme. <sup>2)</sup>
	The filter is clogged.	Clean the filter. <sup>3)</sup>
	The Dry Plus function was in minimum mode.	Change the Dry Plus function to the moderate or maximum mode.
	The condenser is clogged.	Clean the condenser. <sup>3)</sup>
	Load is too big	Obey the maximum load volume.
	The airflow grill is clogged.	Clean the airflow grill in the bottom of the appliance.
	Dirt on the inner surface of the drum.	Clean the inner surface of the drum.
	Too high water hardness.	Set applicable water hardness <sup>4)</sup> .
The door does not close.	The filter not locked in the position.	Put the filter in the correct position.
	The laundry is locked between the door and the seal.	Put the load correctly in the drum.
<b>Err</b> (Error) on the display.	You try to change the programme or the function after the start of the cycle.	Turn the tumble dryer off and on. Make the new selection.
	The function you try to activate is not applicable with the selected programme.	Turn the tumble dryer off and on. Make the new selection.
No drum light	Defective drum light.	Contact the service centre to replace the drum light.

Problem <sup>1)</sup>	Possible cause	Remedy
Abnormally elapsing time on the display.)	The time to end is calculated on the basis of the volume and dampness of the laundry.	The automatic procedure — this is not the appliance malfunction.
Programme inactive.	The water container is full.	Drain the water container <sup>3)</sup> , push the Start/Pause button.
Drying cycle too short.	Too small laundry volume.	Do the selection of time programme. The time value must be related to the load. To dry one item or small quantities of the laundry we recommend to use short times.
	The laundry is too dry.	Do the selection of time programme or higher drying level (e.g. Extra Dry)
Drying cycle too long <sup>5)</sup>	The filter is clogged.	Clean the filter.
	Too high volume of the load.	Obey the maximum load volume.
	The laundry not spun sufficiently.	Spin correctly the laundry.
	Very high room temperature - this is not the appliance malfunction.	If possible, lower the room temperature.

**1)** If there is an error message on the display (e.g. **E51**): Turn the tumble dryer off and on. Make a selection of the new programme. Push the Start/Pause button. Does not operate? - contact the service centre and give the error code.

**2)** follow the programme description — see *PROGRAMMES* chapter

**3)** see *CARE AND CLEANING* chapter

**4)** see section *WATER HARDNESS* in *HINTS AND TIPS* chapter

**5)** Note: After maximum 5 hours the drying cycle ends automatically (see *Drying cycle complete* section).

## DRUM INTERNAL LAMP

This appliance has an internal lamp that comes on when you open the door and goes off when the door is closed.



To replace the internal lamp, contact the service centre. Disconnect the mains plug from the mains socket before the replacement of the internal lamp.



### WARNING!

Do not look directly into the beam of the lamp.

## TECHNICAL INFORMATION



height x width x depth	850 x 600 x 600 mm (maximal 640 mm)
drum volume	118 l
maximum depth with the load door opened	1090 mm
maximum width with the load door opened	950 mm
adjustable height	850 mm (+ 15 mm - feet regulation)
the appliance weight	43 kg
maximum load	<b>8</b> kg
voltage	230-240 V
frequency	50 Hz
total power	2250 W
type of use	Domestic
permitted ambient temperature	+ 5°C to + 35°C

# INSTALLATION

## APPLIANCE POSITIONING

- The tumble dryer must be installed in a clean position, where dirt does not collect.
- Air must flow freely around the appliance. Make sure that the front airflow slots in the bottom of the appliance are not blocked.
- To keep vibration and noise at the minimum, when the tumble dryer operates, it must be put on a stable and flat surface.
- When the appliance is put in its permanent position, check it is fully level with the aid of a spirit level. If it is not, adjust the feet until it is.
- Do not remove the feet. Do not decrease the floor clearance through thick carpets, plank of wood or piece of wood. This can increase the heat which can cause interference with the operation of the appliance.



- The temperature of the hot air inside the tumble dryer can exceed 60 °C. The appliance must not be installed on the floor which is not resistant to high temperatures.
- When the tumble dryer operates, the room temperature must not be lower than +5 °C and higher than +35 °C. This can cause unwanted effect on the performance of the appliance.
- If it is necessary to move the appliance, it must be moved vertically.
- The appliance must not be installed behind a lockable door, a sliding door, a door with a hinge on the opposite side to that of the appliance in such a way that a full opening of the tumble dryer is restricted.

## UNPACKING



### CAUTION!

Before use all parts of the transport packaging must be removed. To remove the polystyrene blockages:

1. Open the load door.

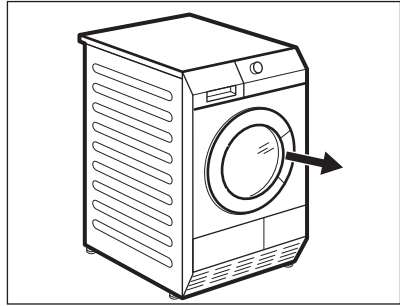

2. Pull plastic hose with the polystyrene blockages out from the drum.

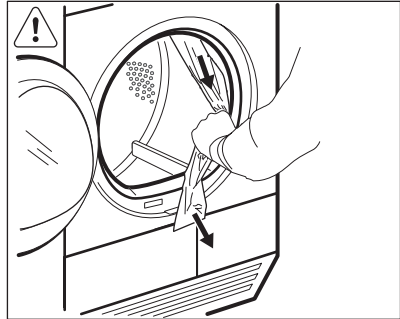

It is possible to adjust the height of the tumble dryer. To do that adjust the feet (see picture).

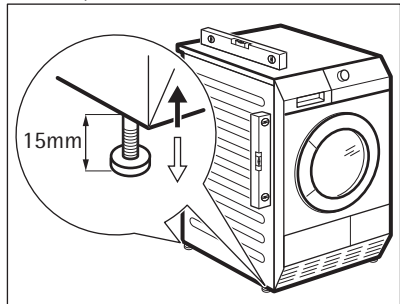

## INSTALLATION UNDER A COUNTER

The appliance can be installed as free-standing or below the kitchen counter with correct space (see picture).

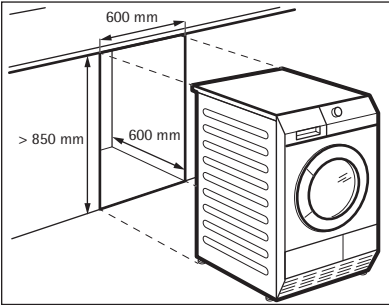

## THE LOAD DOOR REVERSAL

The load door can be installed by the user in the opposite side. It can help to easily put and remove the laundry or if there is a limit to install the appliance. (see separate leaflet).

## ELECTRICAL CONNECTION

- Connect the machine to an earthed socket, in accordance with current wiring regulations.

- Make sure that the electrical data on the rating plate agrees with the power supply.
- Always use a correctly installed shockproof socket.
- Do not use multiple plugs and extension cables. There is a risk of fire.
- If the supply cord of this appliance is damaged, it must be replaced by the manufacturer, its service agent or similarly qualified persons to avoid a hazard.
- Make sure not to squash or cause damage to the mains plug and cable behind the appliance.
- Do not pull the mains cable to disconnect the appliance. Always pull the mains plug.
- The plug must be dry.

**This document sets out the terms and conditions of the product warranties for AEG Appliances. It is an important document. Please keep it with your proof of purchase documents in a safe place for future reference should you require service for your Appliance.**

1. In this warranty
  - a) 'acceptable quality' as referred to in clause 10 of this warranty has the same meaning referred to in the ACL;
  - b) 'ACL' means Trade Practices Amendment (Australian Consumer Law) Act (No.2) 2010;
  - c) 'Appliance' means any AEG product purchased by you accompanied by this document;
  - d) 'ASC' means AEG' authorised serviced centres;
  - e) AEG is the brand controlled by Electrolux Home Products Pty Ltd of 163 O'Riordan Street, Mascot, NSW 2020, ABN 51 004 762 341 in respect of Appliances purchased in Australia and Electrolux (NZ) Limited of 3-5 Niall Burgess Road, Mount Wellington, in respect of Appliances purchased in New Zealand;
  - f) 'major failure' as referred to in clause 10 of this warranty has the same meaning referred to in the ACL and includes a situation when an Appliance cannot be repaired or it is uneconomic for Electrolux, at its discretion, to repair an Appliance during the Warranty Period;
  - g) 'Warranty Period' means:
    - where the Appliance is used for personal, domestic or household use (i.e. normal single family use) as set out in the instruction manual, the Appliance is warranted against manufacturing defects in Australia and New Zealand for 60 months, following the date of original purchase of the Appliance;
    - this Appliance is not designed for commercial use and therefore no warranty applies in this case;
  - h) 'you' means the purchaser of the Appliance not having purchased the Appliance for resale, and 'your' has a corresponding meaning.
2. This warranty only applies to Appliances purchased and used in Australia or New Zealand and is in addition to (and does not exclude, restrict, or modify in any way) any non-excludable statutory warranties in Australia or New Zealand.
3. During the Warranty Period AEG or its ASC will, at no extra charge if your Appliance is readily accessible for service, without special equipment and subject to these terms and conditions, repair or replace any parts which it considers to be defective. AEG or its ASC may use remanufactured parts to repair your Appliance. You agree that any replaced Appliances or parts become the property of AEG. This warranty does not apply to light globes, batteries, filters or similar perishable parts.
4. Parts and Appliances not supplied by AEG are not covered by this warranty.
5. You will bear the cost of transportation, travel and delivery of the Appliance to and from AEG or its ASC. If you reside outside of the service area, you will bear the cost of:
  - a) travel of an authorised representative;
  - b) transportation and delivery of the Appliance to and from AEG or its ASC,

In all instances, unless the Appliance is transported by AEG or an AEG authorised representative, the Appliance is transported at the

- owner's cost and risk while in transit to and from AEG or its ASC.
6. Proof of purchase is required before you can make a claim under this warranty.
  7. You may not make a claim under this warranty unless the defect claimed is due to faulty or defective parts or workmanship. AEG is not liable in the following situations (which are not exhaustive):
    - a) the Appliance is damaged by:
      - accident
      - misuse or abuse, including failure to properly maintain or service
      - normal wear and tear
      - power surges, electrical storm damage or incorrect power supply
      - incomplete or improper installation
      - incorrect, improper or inappropriate operation
      - insect or vermin infestation
      - failure to comply with any additional instructions supplied with the Appliance;
    - b) the Appliance is modified without authority from AEG in writing;
    - c) the Appliance's serial number or warranty seal has been removed or defaced;
    - d) the Appliance was serviced or repaired by anyone other than AEG, an authorised repairer or ASC.
  8. This warranty, the contract to which it relates and the relationship between you and AEG are governed by the law applicable where the Appliance was purchased. Where the Appliance was purchased in New Zealand for business purposes the Consumer Guarantee Act does not apply.
  9. To the extent permitted by law, AEG excludes all warranties and liabilities (other than as contained in this document) including liability for any loss or damage whether direct or indirect arising from your purchase, use or non use of the Appliance.
  10. For Appliances and services provided by AEG in Australia, the Appliances come with a guarantee by AEG that cannot be excluded under the Australian Consumer Law. You are entitled to a replacement or refund for a major failure and for compensation for any other reasonably foreseeable loss or damage. You are also entitled to have the Appliance repaired or replaced if the Appliance fails to be of acceptable quality and the failure does not amount to a major failure. The benefits to you given by this warranty are in addition to your other rights and remedies under a law in relation to the Appliances or services to which the warranty relates.
  11. At all times during the Warranty Period, AEG shall, at its discretion, determine whether repair, replacement or refund will apply if an Appliance has a valid warranty claim applicable to it.
  12. For Appliances and services provided by AEG in New Zealand, the Appliances come with a guarantee by AEG pursuant to the provisions of the Consumer Guarantees Act, the Sale of Goods Act and the Fair Trading Act.
  13. To enquire about claiming under this warranty, please follow these steps:
    - a) carefully check the operating instructions, user manual and the terms of this warranty;
    - b) have the model and serial number of the Appliance available;
    - c) have the proof of purchase (eg an invoice) available;
    - d) telephone the numbers shown below.
  14. You accept that if you make a warranty claim, AEG and its ASC may exchange information in relation to



you to enable AEG to meet its obligations under this warranty.

### Important Notice

Before calling for service, please ensure that the steps listed in point 13 above have been followed.

#### FOR SERVICE

or to find the address of your nearest state service centre in Australia  
**PLEASE CALL 1300 363 664**

**OR EMAIL [customer-care@aegaustralia.com.au](mailto:customer-care@aegaustralia.com.au)**

For the cost of a local call (Australia only)

#### SERVICE AUSTRALIA



[www.aeg.com/au](http://www.aeg.com/au)

#### FOR SPARE PARTS

or to find the address of your nearest state spare parts centre in Australia  
**PLEASE CALL 13 13 50**  
**OR EMAIL [customer-care@aegaustralia.com.au](mailto:customer-care@aegaustralia.com.au)**

For the cost of a local call (Australia only)

#### FOR SERVICE

or to find the address of your nearest authorised service centre in New Zealand  
**FREE CALL 0800 10 66 10**

**OR EMAIL [customer-care@electrolux.co.nz](mailto:customer-care@electrolux.co.nz)**

(New Zealand only)

#### SERVICE NEW ZEALAND



#### FOR SPARE PARTS

or to find the address of your nearest state spare parts centre in New Zealand  
**FREE CALL 0800 10 66 20**

**OR EMAIL [customer-care@electrolux.co.nz](mailto:customer-care@electrolux.co.nz)**

(New Zealand only)





