



RV | ***OWNER'S
MANUAL***

WARNING

Never use any fuel-burning products (stoves, lanterns, heaters, etc.) inside or within proximity of this tent. Use of fuel-burning products inside or within proximity of this tent can result in the accumulation of dangerous concentrations of carbon monoxide – a colourless, odourless gas. Breathing carbon monoxide will cause serious injury or death. Avoid spraying your tent with deodorant as it will destroy the waterproofing.

Keep all flame and heat sources away from this tent. This tent is made with flame resistant fabric but it is not fireproof. The tent fabric will burn if left in continuous contact with an open flame or other heat source. Failure to keep all flame and heat sources away from this tent can result in a fire that can burn.

Before using this product, read and fully understand: (1) attached warnings; (2) the instruction manual and all accompanying documentation. Failure to follow these directions can cause an unsafe situation leading to injury.

USING AND CARING

CONDITIONING YOUR CANVAS

It is vitally important that you season your canvas when it's new and also after long periods of storage so it gives its best performance. Simply pitch your tent and wet it down with a garden hose. This enables the stitching holes to shrink around the tread of the stitch lines and the cotton in the canvas to swell. Let the canvas dry completely before repeating this two times.

TIP AND TRADITIONAL FIRST AID FOR CANVAS

Even though you may have seasoned your canvas, sometimes you can miss a spot or a seam. An age old remedy if this happens is to carry a clear wax candle with you when you go camping. If you do notice a seam has not been seasoned properly, simply rub the candle on the exterior of the stitch line. This will create a waterproof barrier quickly and easily.

If cared for correctly, your Oztent canvas will still be around for the next generation of campers to enjoy.

VENTILATION

Maintain adequate ventilation inside your tent at all times.

CAMPSITE CHOICE

When choosing a campsite, carefully consider the possibility of falling rocks or tree limbs, lightning, flash floods, avalanches, strong winds, and other potential hazards to reduce the risk of loss or injury to the tent or occupants.

Select a site that's level, will drain well if it rains, and is protected from wind and other elements. Clear the area of sharp stones, sticks, and other debris, both for comfort and to protect your floor. If possible, avoid setting the tent on ground that is already wet. If you can't, minimize the resulting humidity and potential of condensation by keeping your tent well ventilated.

PEGS AND ROPES

Peg down your tent properly at all times to reduce the risk of loss or injury to the tent or occupants.

All tents require pegging to prevent them from flying away in a gust of wind. Always anchor your Oztent. Enough pegs and ropes are supplied to safely setup your tent in most situations. It may be necessary to purchase additional and/or specialized pegs and ropes for

use in extreme or varied soil conditions. For optional sand pegs Oztent recommends use of a Bluescrew Oztent Edition.

Tightly tensioning your tent with our attached ropes greatly increases the tent's strength and stability. This will also reduce fabric droop and wrinkles, and prevent rainwater from pooling. To pull out a peg never use the edge of the tent as a handle. If hard to remove, use of another peg as a hook is recommended.

USING A FLOOR SAVER

A Floor Saver keeps your tent floor clean and dry and it minimises floor wear and tear by protecting it from excessive abrasion.

CONDENSATION

Condensation is an unavoidable fact of physics. When warm, moist air comes in contact with the cool tent fabric, it forms condensation. In most conditions condensation can be controlled by allowing air inside the tent to vent outside. During periods of high humidity, such as rain, it can be too difficult to remove or reduce condensation. In these conditions, a high degree of ventilation can actually increase the condensation by drawing in more humid air.

To reduce condensation use Oztent Fly. Your Oztent Fly is designed to collect humid air that pass through your tent. It is normal to find the underside of the fly covered in water droplets in humid conditions.

Condensation can also collect on parts of the floor inside the tent. This is also normal and does not indicate leaking fabric.

ZIPPERS

Be careful with your zippers. Go slow when zipping. Make sure to align the tracks before sliding the zipper—and don't exert excessive force. If fabric gets caught in the slider, stop and slowly reverse the slider to remove. A silicone based lubricant may be used to zip life.

When dirt gets in the zipper teeth, they can cause abrasion and damage to the zipper sliders. You can clean the zipper teeth by rinsing them out with water. The pressure from a regular garden hose will push out small sand particles.

CLEANING

If your tent should require cleaning, set it up and use a sponge with warm water. If further cleaning is needed, a garden hose should be able to wash off any remaining dirt. Do not use detergent, soap, bleach, as these may remove the waterproofing and/or damage the fabric. Allow the tent to air-dry completely before packing or storing.

STORAGE

Packing away and storing your tent while it's wet or damp leads to premature breakdown of the canvas and coatings. Prolonged exposure to moisture causes the waterproof layer to break down, becoming soft, sticky and no longer waterproof. Storing a wet tent can also start the process of mildew forming on the fabric. Mildew will cause your tent to stain, smell, and will lead to the premature breakdown of the waterproof coating. Dry your tent thoroughly after every trip.

ANIMALS

To prevent damage from animals chewing holes in the fabric, never store food or cooking equipment in your tent.

Please ensure when packing away that there are no insects inside as these little pests will eat their way out causing holes to appear in the material.

IMPORTANT NOTES

- 1.** If you have an Oztent Floor Saver, place it where you want to set-up your tent and execute the following instructions on top of it.
- 2.** If you have an Oztent Standard Fly, assemble it before Step 6 of "Setting Up Your Tent" in the following instructions.
- 3.** Pack your tent away in the reverse order of putting up. Roll up your rear window and front awning and leave the front door in open position. After, take your poles and pegs out. Lower the tent on the ground and first swing in arm A then arm B. Always, swing the arms low to the bottom.
- 4.** If you have an Oztent RV-4 or RV- 5, before putting down, make sure you bring inside the extension at the back of the tent.
- 5.** Although the Oztent and it's accessories are designed for one person operation, a second person will make your set-up significantly easier and faster.
- 6.** The following Illustrations are artistic representations of the Oztent and may differ from the production model you have. However, the overall operation will be virtually the same.

SETTING UP YOUR OZTENT

- 1.** Take your Oztent out of the bag. Place your poles, pegs and fly somewhere clear from your tent space.

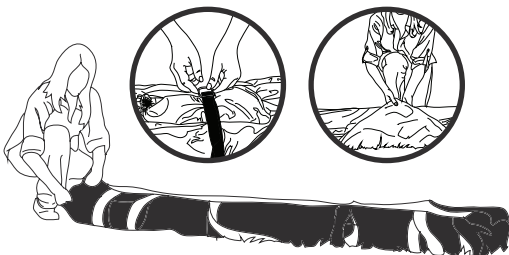

- 2.** Swing out Arm A.

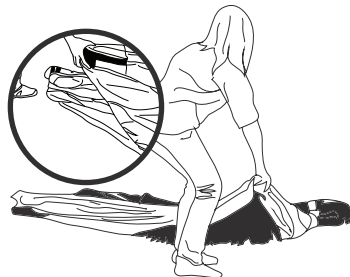

- 3.** Swing out Arm B.

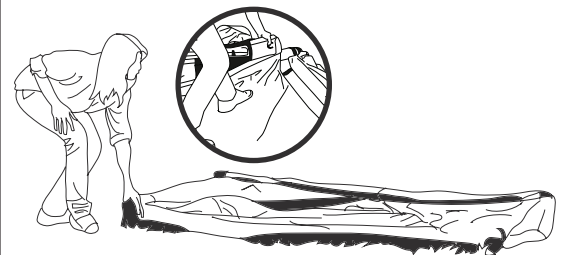

SETTING UP YOUR OZTENT

- 4.** Swing your tent up from the swing tab found near the top frame.

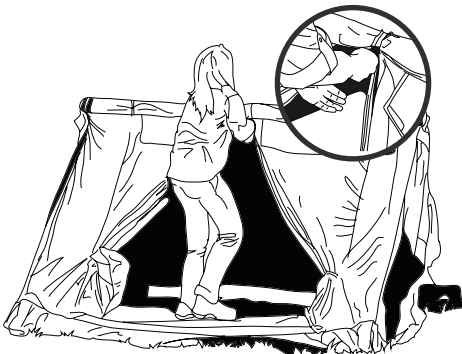

- 5.** Reach inside the tent and velcro the internal frames to lock in place.

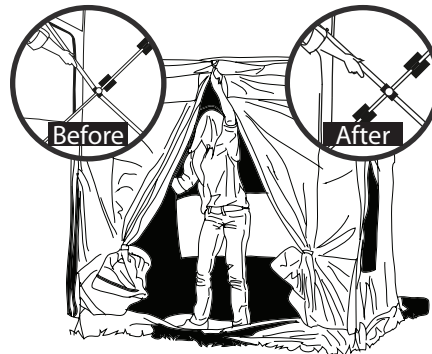

- 6.** Adjust your tent so it sits properly.



SETTING UP YOUR OZTENT

- 7.** Hammer in all bottom Pegs.

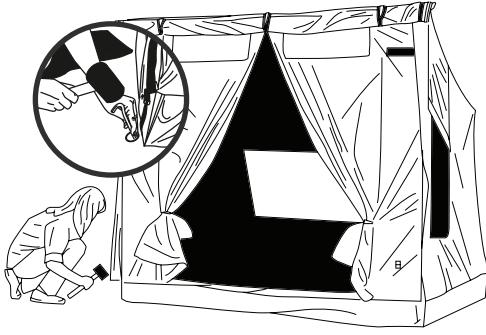

- 8.** Pull out the guy ropes and peg them down at a rough 45 Degree angle to secure your tent.

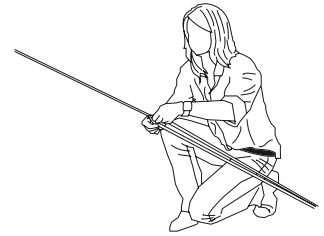
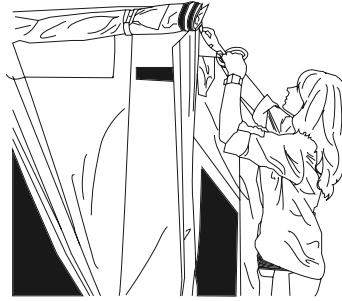

SETTING UP YOUR AWNING

- 9.** Extend the awning. Twist to unlock awning poles and twist again to lock at desired height. Pop up the awning and secure with guy ropes as shown.

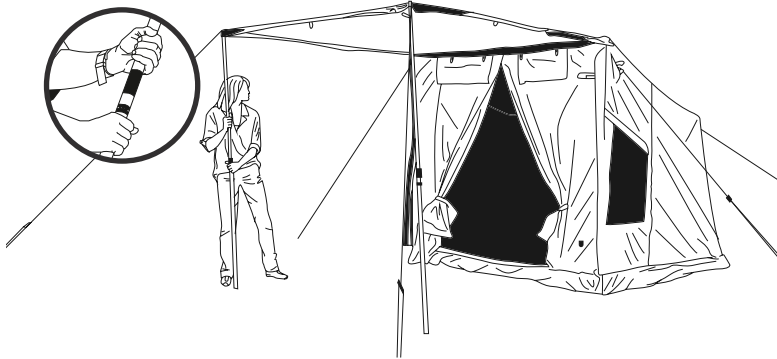

OPTIONAL

Lower one pole during heavy rain.

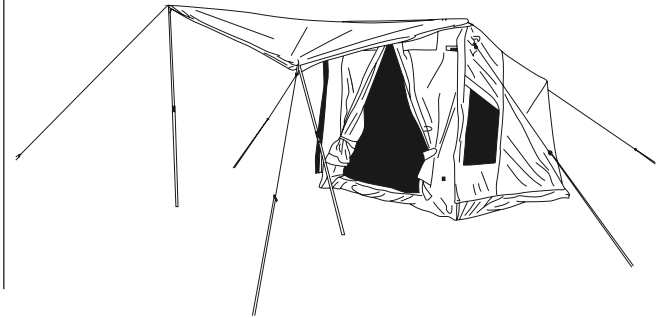

OPTIONAL ACCESSORIES

SETTING UP YOUR OZTENT FLY

1. Throw your Oztent Fly over the erected tent. Tilt it forward and zip the Oztent Fly on the top of the tent.

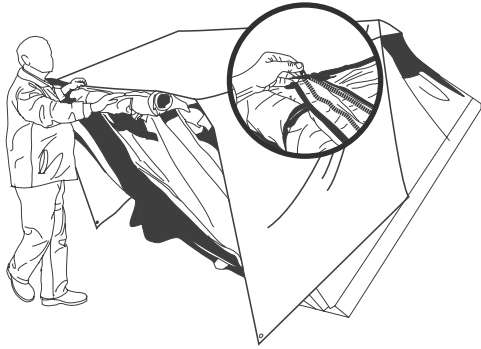

2. Place the 1.7m poles on each side to create spacing and secure with guy ropes as shown.



SETTING UP YOUR PEAK SIDE PANELS

1. Install your 2.2m Awning Poles. Lock them at the height of your tent roof at first.

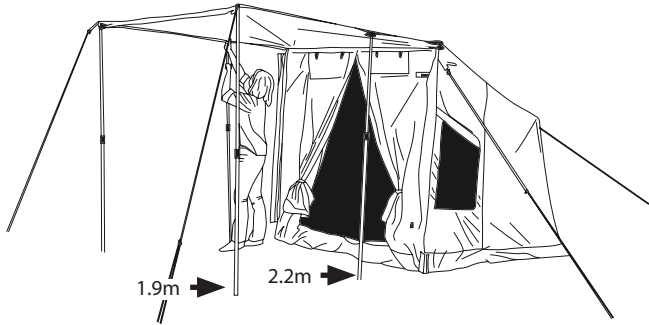

2. Assemble your ridge pole. Twist to lock at desired location.

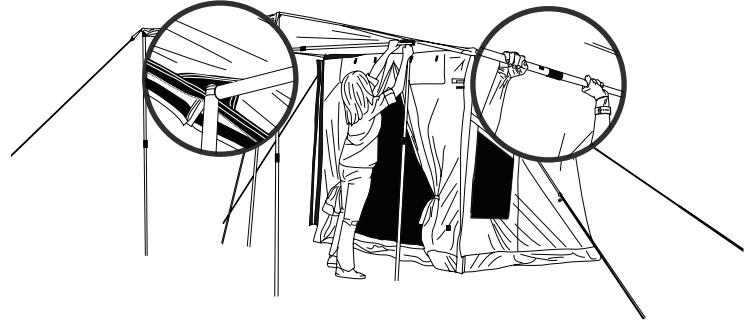

SETTING UP YOUR PEAK SIDE PANELS

3. Zip on the side panels. Panels are marked A and B. Match against the A,B markings on the tent.

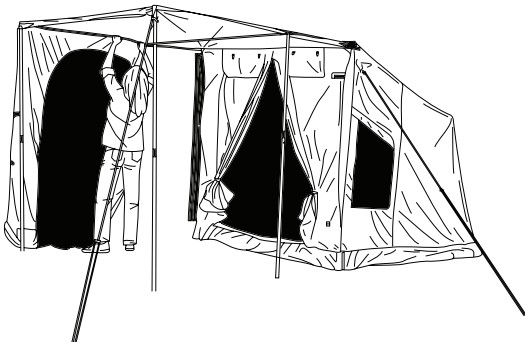

4. Fully extend the 2.2m Awning Poles when the Peaked Side Panel is zipped on half way.

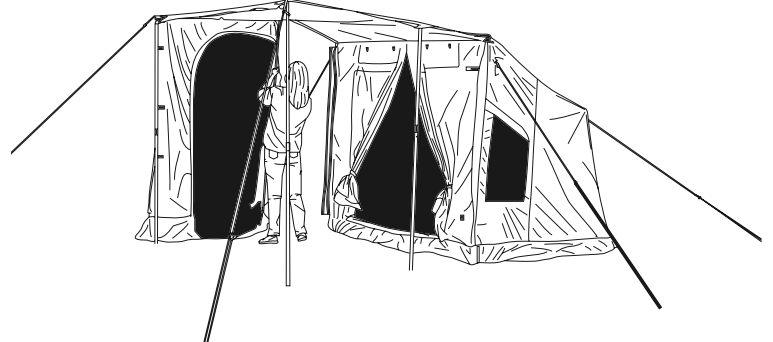

SETTING UP YOUR PEAK SIDE PANELS

5. Zip on the rest of the Peaked Side Panel. Secure the velcro tabs to the poles.

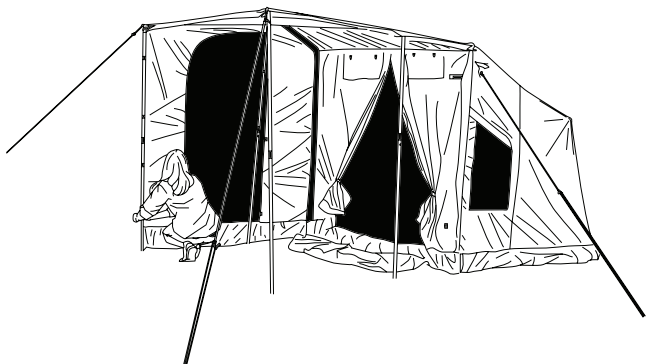

6. Repeat for the second panel and then extend the 2.2m poles.

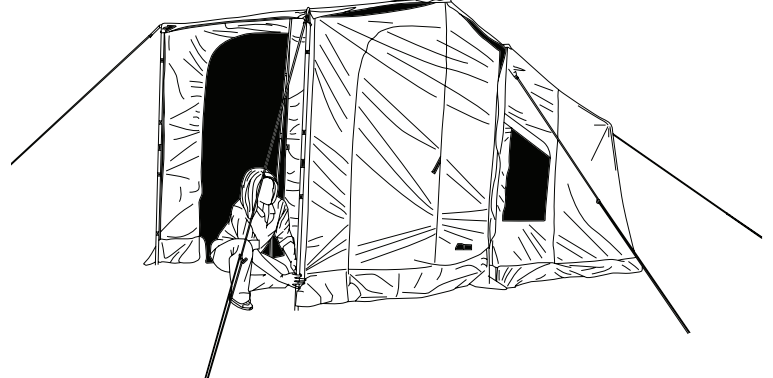

SETTING UP YOUR FRONT PANEL

- 1.** Assemble your ridge pole. twist to lock at desired location.

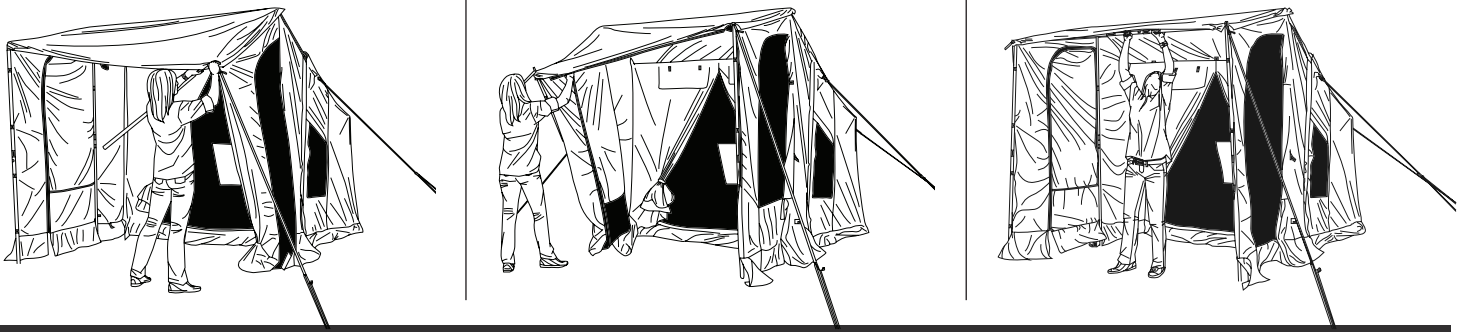

SETTING UP YOUR FRONT PANEL

- 2.** Zip the Front Panel on from Right to Left.

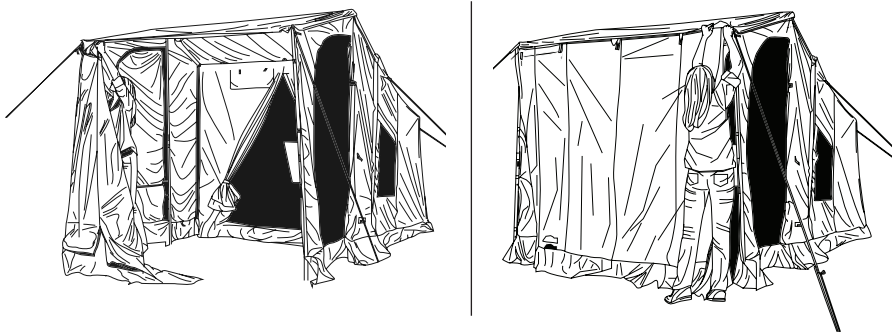

- 3.** Zip the sides of the Front Panel to the sides of the Side Panels and secure velcro tabs.

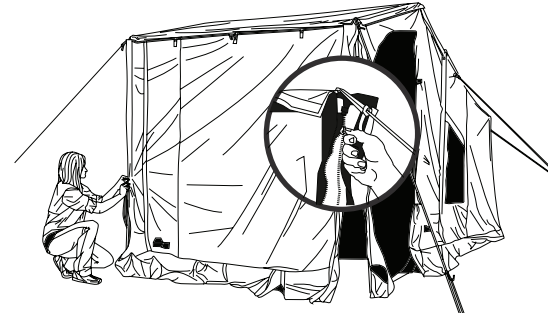

*Additional poles, pegs and ropes available for purchase to allow the Front Panel to be set up as another awning.

SETTING UP YOUR TAGALONG TENT

- 1.** Unpack your Oztent Tagalong Tent. Insert the Ridge Pole in your Oztent Awning. Twist and lock Ridge Pole when in place.



- 2.** Attach your Tagalong Tent, right hand side first.



Zip from right to left.



SETTING UP YOUR TAGALONG TENT

- 3.** Attach top corner straps to your Oztent Awning Poles. Tighten straps. Attach velcro straps of Tagalong Tent on Oztent Awning Poles.

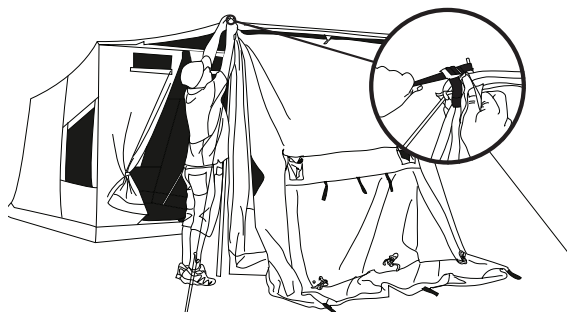

- 4.** Peg at all base peg points and set up support poles. Extend all guy ropes, peg and secure.

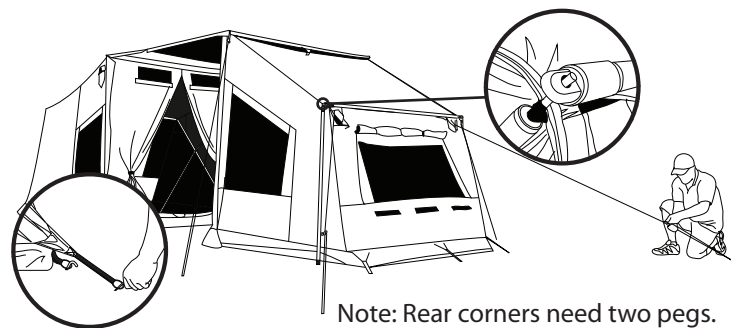

COMPLETE PARTS LIST

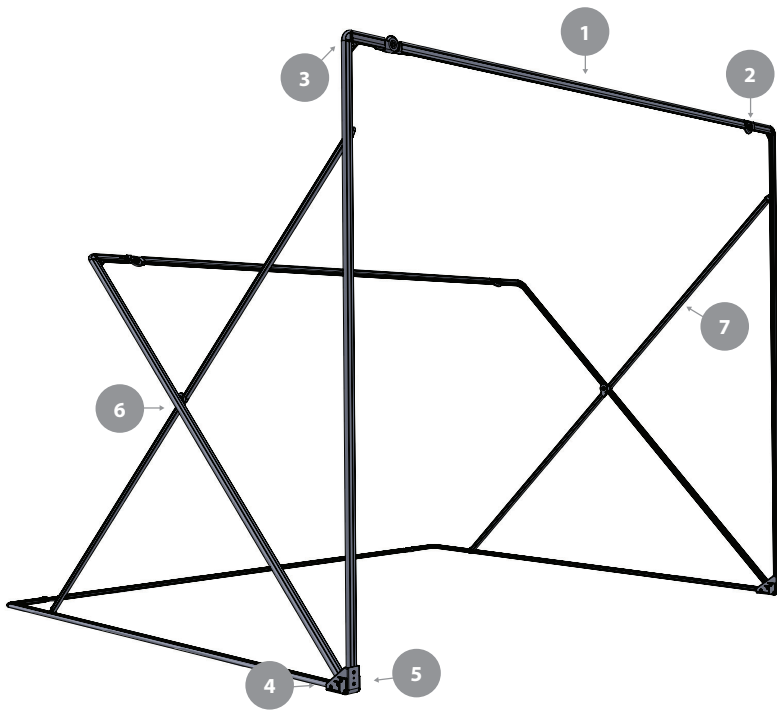

1. Main Extrusion (May Require Cutting)

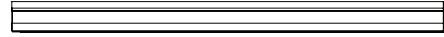

2. Hinge

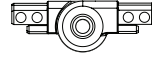

3. Corner



4. Foot fitting



5. Foot



6. M8 Nut, Washer and Slider



7. Brace Extrusion with Fittings

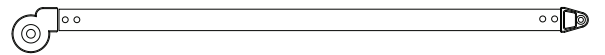

OZTENT AUSTRALIA PTY LTD AUSTRALIAN WARRANTY CARD

IMPORTANT – REGISTRATION REQUIRED

This manufacturer's warranty will only be valid if your product purchase is registered with Oztent Australia Pty Ltd (Oztent). To register, complete this card and return it to us, along with a copy of your receipt, at the address below within 14 days of purchase. If you have purchased more than one item, you may register them on the same card but you will need to provide a receipt for each product.

Oztent will confirm receipt within 14 days and issue a Customer Registration Number. If you have not received your Customer Registration Number within 14 days please phone us to confirm we have received your registration. This manufacturer's warranty will not be valid if your product is not registered.

**Oztent Australia
Warranty Registrations
PO Box 6230
Wetherill Park NSW 2164**

Oztent Australia Pty Ltd (Oztent) will repair or replace any registered Oztent product if that product requires repair due to a manufacturing or materials defect (such as water leaks, faulty stitching, delamination, faulty zips, faulty fittings or faulty material) appearing and notified to Oztent within the following warranty periods:

**Furniture - 5 years from date of purchase
Tents & Awnings - 2 years from date of purchase
Any other product - 1 year from date of purchase**

EXCLUSIONS. This manufacturer's warranty is limited to manufacturing or materials defects. This does not include damage caused by wear and tear, condensation, dragging, abuse or misuse, accidents, falling objects, improper set up, burn holes, extreme weather or damage caused by insects, animals or children.

HOW TO MAKE A CLAIM. To make a claim on this manufacturer's warranty please return your product to Oztent at the address below. You must provide your Customer Registration Number with the product. If you purchased the product less than 14 days ago, or you have lost your Customer Reference Number, please telephone Oztent between Monday to Friday 9:00am to 5:00pm (Sydney time). All transport costs related to returning the product for assessment or repair under this manufacturer's warranty is payable by the customer.

OTHER RIGHTS. The benefits given by this manufacturer's warranty are additional to other rights and remedies that you may have under law. Our goods come with guarantees that cannot be excluded under the Australian Consumer Law. You are entitled to a replacement or refund for a major failure and for compensation for any other reasonably foreseeable loss or damage. You are also entitled to have the goods repaired or replaced if the goods fail to be of acceptable quality and the failure does not amount to a major failure.

Important notice: Details of the product in this owner's manual may vary from the actual product. Images are for illustrative purposes only.



FOR MORE INFORMATION
Visit: www.oztent.com
E-mail: sales@oztent.com
or Call Toll Free at: 1800 632 416