

Instruction Manual

Please read these instructions fully
before using this product

Smart Living Steam Mop Plus

With all new design enhancements





Contents

SAFETY INSTRUCTION

2-3 Safety Instruction

GETTING STARTED

4 Parts and Features

5-6 Assembly

OPERATION

7-8 Using your Steam Mop

9 Using your Carpet Glider

CARE AND STORAGE

10 Care and Cleaning

10 Storage

TROUBLE SHOOTING

11 Trouble Shooting

REPLACEMENT PARTS

12 Replacement Parts Ordering

TECHNICAL PARAMETER

12 Technical Parameter

AFTER SALES RETURNS FORM

13 After Sales Returns Form - Guarantee Slip

BASIC SAFETY PRECAUTIONS SHOULD ALWAYS BE FOLLOWED WHEN USING THE STEAM MOP. READ ALL INSTRUCTIONS BEFORE USAGE.

1. Use only as described in this manual.
2. Use only manufacturer's recommended accessories.
3. Do not use outdoors.
4. Do not leave the appliance unattended when plugged in. Always unplug the power cord from the electrical outlet when not in use and before servicing.
5. Do not allow the appliance to be used as a toy. Close attention is necessary when used by or near children, pets or plants.
6. Do not operate the appliance with a damaged plug or cord, or if the unit has been dropped or damaged. Return it to the manufacturer or the relating maintenance department for examination and repair.
7. Do not pull or carry by power cord, use power cord as handle, close a door on the power cord, or pull the power cord around sharp edges or corners. Keep power cord away from heated surfaces.
8. Do not unplug by pulling on power cord. To unplug, grasp the plug not the power cord.
9. To avoid the risk of electric shock:
 - a) Do not immerse the appliance into water or any other liquids.
 - b) Do not handle plug or the unit with wet hands or operate appliance without shoes.
 - c) Do not use extension cords or outlets with inadequate current carrying capacity.
 - d) Do not disassemble or attempt to repair the appliance on your own.
Incorrect reassembly or repair can cause a risk of electrical shock or injury to persons when the appliance is used.
10. Keep your work area well lit.
11. Use only on flat, horizontal surfaces. Do not use on walls, counters or windows.
12. Do not use on leather, wax polished furniture or floors, synthetic fabrics, velvet or other delicate, steam sensitive materials.
13. Extreme caution should be exercised when using this appliance to clean stairs.
14. When in use, never turn the appliance over or on its side. Never direct steam towards people, animals or plants.
15. Do not put any objects into openings. Do not use with any opening blocked.
16. Do not put hands or feet under the steam mop. Unit gets very hot.

WARNING Your steam mop is designed to clean hard floor surfaces that will withstand high heat. Do not use on unsealed wood or unglazed ceramic floors. On surfaces that have been treated with wax or some no wax floors, the sheen may be removed by the heat and steam action. It is always recommended to test an isolated area of the surface to be cleaned before proceeding. We also recommend that you check the use and care instructions from the floor manufacturer.

17. Never use the steam mop without a microfiber pad attached.
18. Do not add cleaning solutions, scented perfumes, oils or any other chemicals to the water used in this appliance as this may damage the unit or make it unsafe for use. If you live in a hard water area, we recommend using distilled water in your steam mop.
19. Carefully remove the microfiber pad immediately after you have unplugged and allowed the unit to cool.
20. When cleaning the steam mop, unplug the power cord from the electrical outlet and clean with a dry or damp cloth. Do not pour water or use alcohol, benzene or paint thinner on the unit.
21. Store the appliance indoors in a cool, dry area.
22. Do not store unit with damp/wet microfiber cleaning pad attached. Never leave the steam mop in one spot on any surface for any period of time with a damp or wet microfiber cleaning pad attached as this will damage your floors.

DANGER OF SCALDING

Please use caution when using the steam mop. The steam emitted is very hot.

Parts and Features

The Smart Living Steam Mop is designed to clean surfaces that will withstand high heat and moisture.

Do not use on unsealed wood surfaces (especially wooden antique furniture), unglazed ceramic tile, painted surfaces or surfaces that have been treated with wax, oils, varnishes, or shellac. The sheen may be removed by the heat, steam, and friction of the cleaning tools. Lacquer and polyurethane coating provide a hard durable protective finish that withstands moisture but it is always recommended to test an isolated area of the surface to be cleaned before proceeding.

We also recommend you check the use and care instructions from the floor manufacturer. When cleaning finished wood surfaces, use broad, continuous cleaning strokes. To prevent surface damage, avoid focusing steam or allowing the steam mop to sit in one spot for any amount of time.

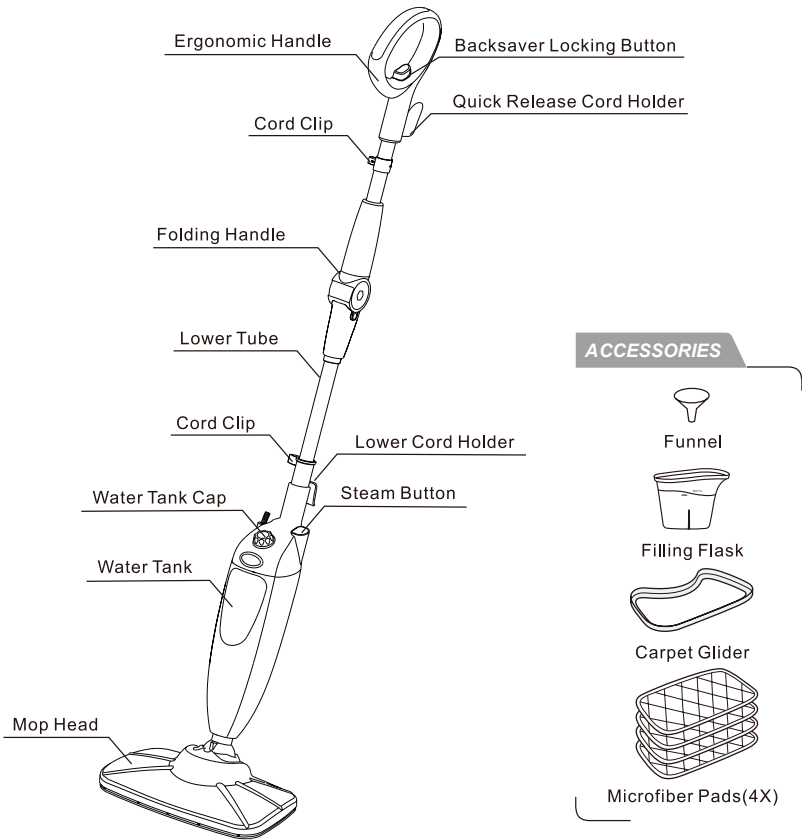

Assembly

When assembling your steam mop, there may be a little water in the water tank. This is because we test all our steam mops 100% before you buy them, so you get a quality steam mop.

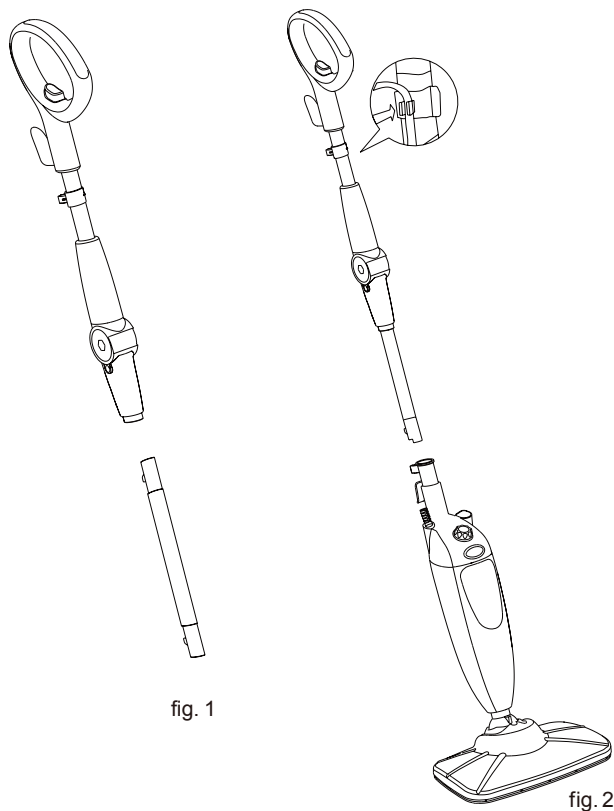

1. Remove all the parts from the package. Verify all the parts are included.
2. Insert the lower tube into the folding handle as shown. (fig.1)
3. Insert the assembled tube into the base of the steam mop. Gently push down on the tube until you hear it click into place. (fig.2)

IMPORTANT

Always make sure the steam mop is unplugged from the electrical outlet when not in use, or before filling the water tank.

TIP Your microfiber cleaning pads should be replaced every 3 months to maximize cleaning performance

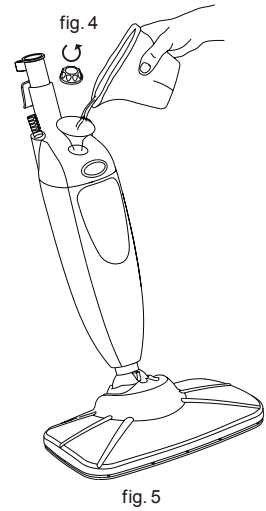
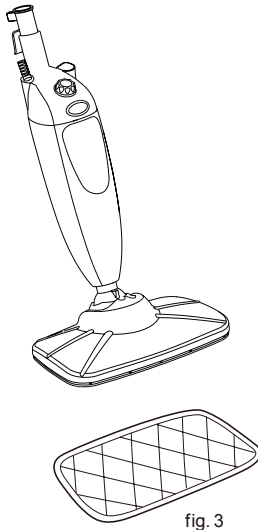

4. Place the microfiber cleaning pad on the floor with quick fastener strips facing up. Simply press the steam mop onto the pad to attach.(fig.3)
5. Remove the water tank cap by turning it counter-clockwise to the unlocked position. (fig.4)
6. A filling flask and funnel are included with your steam mop to make filling the water tank easy. Fill the flask with water and use the funnel to pour water into the tank. Keep the water level under the MAX line. (fig.5)
7. Replace the water tank cap by turning it clockwise to the locked position.

IMPORTANT

Only add water to the tank. Chemicals or cleaning solutions may be unsafe or cause damage. To extend the life of your steam mop, we recommend using distilled water. If you live in an area with hard tap water, we strongly recommend using distilled water.

Operation

When you use your steam mop for the first time or if you have not used the unit in a while, it may take a minute or two for the water to travel through the pump and into the heater to create steam. If you have waited a few minutes and you still do not see any steam, reference the troubleshooting section.

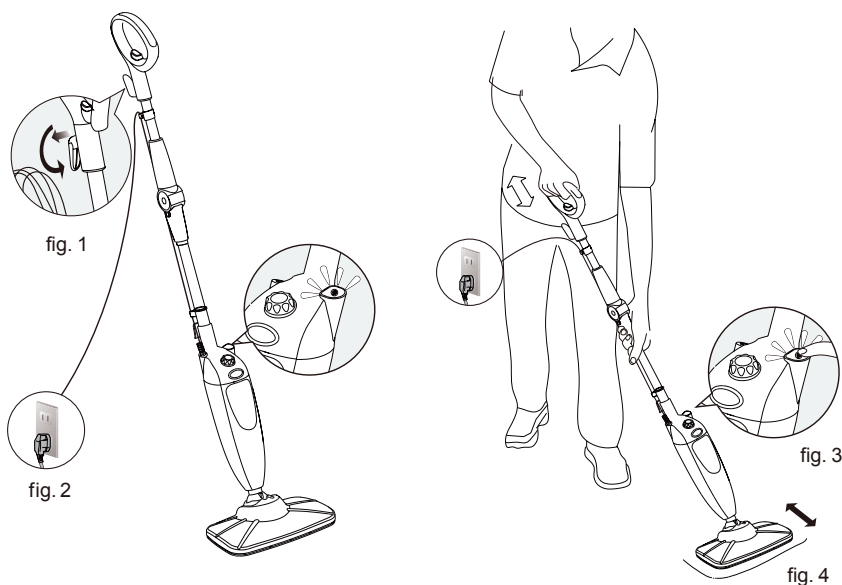

IMPORTANT

Your steam mop needs water to make steam! Never use your steam mop without water in the tank or a pad attached. Sweep or vacuum your floors before using your steam mop. It may take a few seconds for the mop to warm up and start steaming after you plug it in. If you press the steam button and the unit does not begin to steam immediately, just wait a few seconds for the mop to heat up to a deep cleaning and sanitizing temperature

1. Pull and twist the quick release cord holder to unwrap the power cord completely. (fig.1)
2. Plug into a standard electrical outlet. (fig.2) The LED light will blink blue to show that you are in standby mode. If the light does not turn on, reference the trouble shooting section.
3. Press the steam button, the LED light will turn solid blue, and the electronic pump will automatically generate steam.(fig. 3)
4. Clean your floors with a forward and backward motion. (fig.4)
5. Press the steam button at any time to stop the steam.

TIP

Clean under furniture and tight areas, using the FOLDING HANDLE!

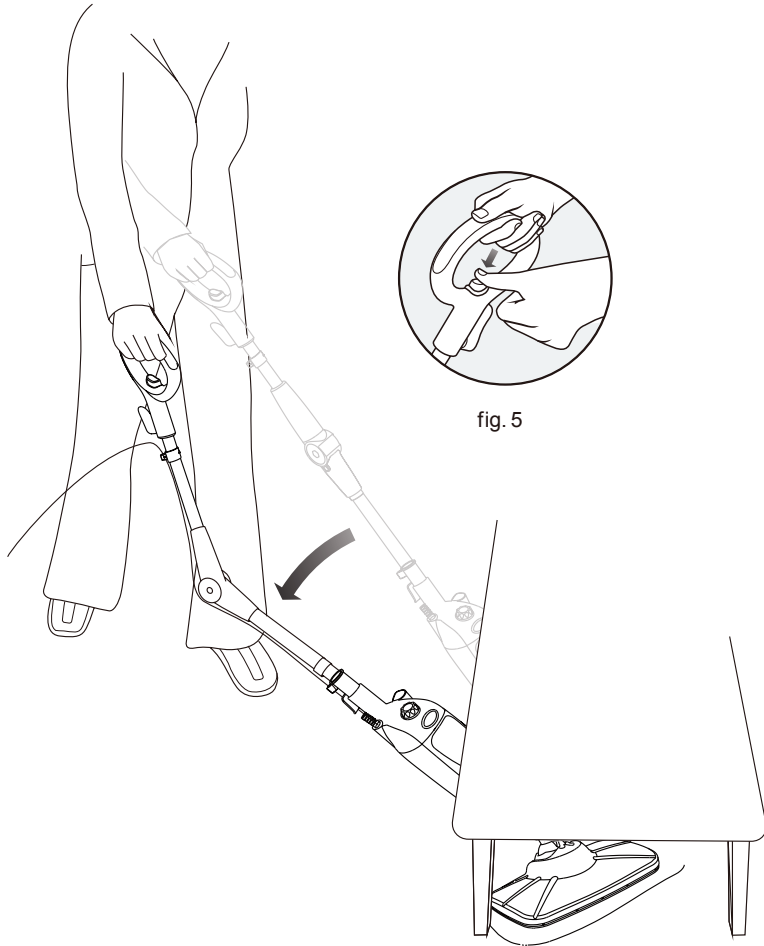

6. Clean under furniture and tight areas using the folding handle benefit. Press the handle release button and apply slight pressure to bend the handle. The folding joint will lock at a perfect, maximizing angle. (fig.5)
7. Press the release button again and pull up to straighten.

Carpet Glider

The steam mop is versatile! The carpet glider transforms your steam mop in no time. Now you can freshen and deodorize your carpets and area rugs with the power of steam.

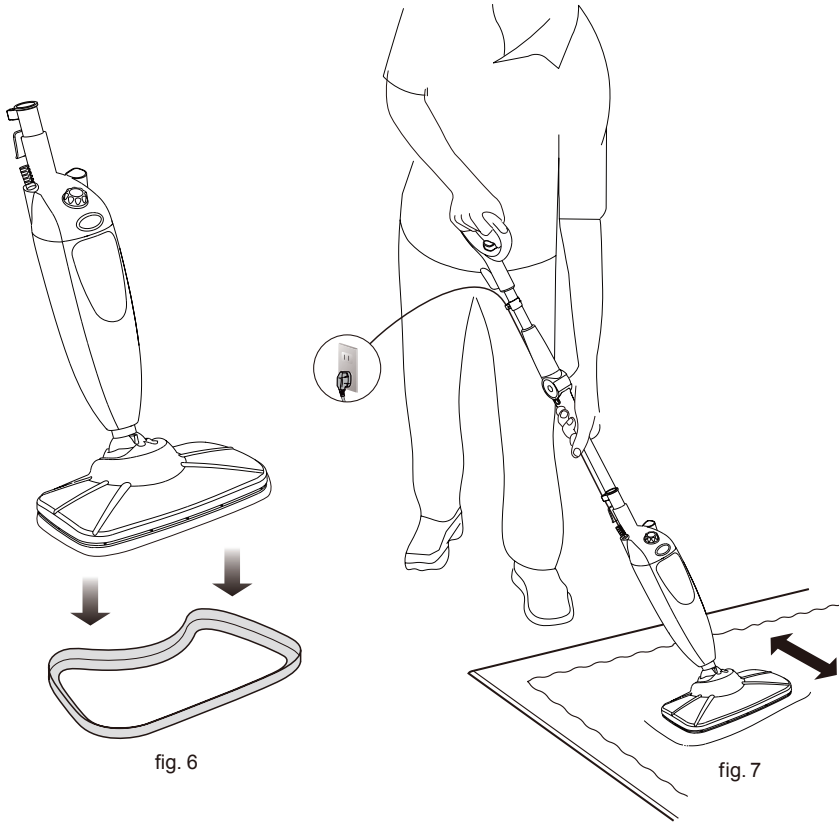

8. Set the carpet glider on the carpet with the smooth side down. Place the mop head, with a pad attached, on top of the carpet glider. The steam mop will rest on top of the glider. (fig. 6)
9. Plug in the steam mop and begin freshening your carpet by pushing the mop and glider back and forth to release steam. (fig. 7) When finished, unplug the steam mop and store it as you would normally.

TIP

The steam mop will not pick-up solid particles or hair from carpets or areas rugs, but it is great for deodorizing and freshening carpet surfaces against tough odors.

Care and Cleaning

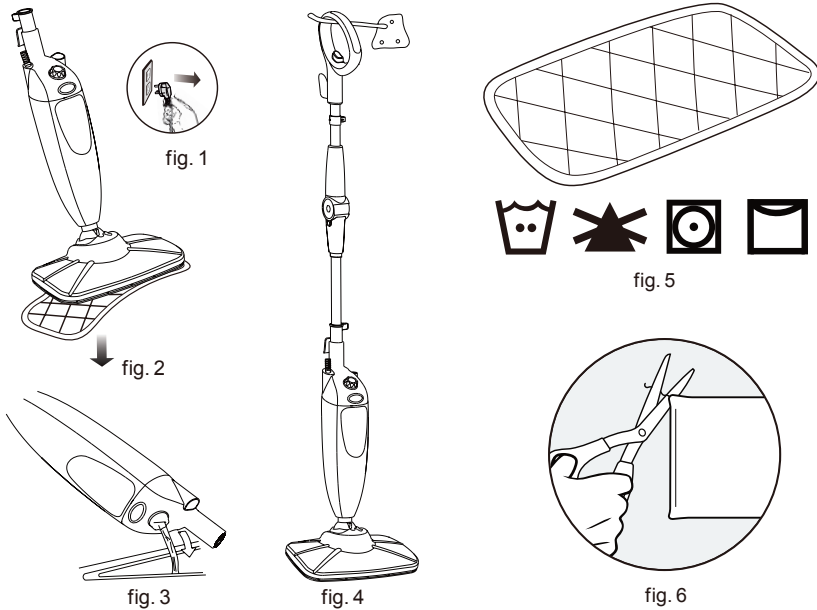

1. When you have finished using the steam mop, press the steam button to stop the unit from steaming. The LED light will blink blue. Unplug the cord from the outlet (fig.1) and place the mop into the upright position and let the unit cool 3-5 minutes.
2. Carefully separate the microfiber cleaning pad from steam mop, avoiding contact with the hot pad or dirt.(fig.2)
3. Empty the water tank before storage. Remove the water tank cap and empty the tank over a sink. Replace the water tank cap.(fig.3)
4. To store the cooled steam mop, hang on a large hook. (fig.4) Or store the steam mop standing upright, leaning against a wall. Make sure it's stored away from children and high traffic areas.
5. Wash pads in warm water. Wash separately from other laundry. Only use liquid detergent (no powder detergent). Do not use fabric softeners. Line dry or dry on a low dryer setting. (fig. 5)
6. If there are loose threads on the pad, carefully cut the threads with scissors. Do not pull on them or cut at the base. (fig. 6)

IMPORTANT

The Cleaning pad may be very hot from the steam after use. Use caution when removing. Let the unit cool for 3-5 minutes first before removing.

Trouble Shooting

PROBLEM	POSSIBLE REASONS & SOLUTIONS
The Steam Mop will not turn on.	<ol style="list-style-type: none">1. The steam mop should be securely plugged into an electrical outlet only.2. Is the LED light on? If not, check your fuse or breaker.
Steam Mop will not make steam.	<ol style="list-style-type: none">1. Is there water in the water tank? If not, add water to your steam mop following instructions.2. Is the LED light blinking blue? If so, press the steam button to activate the steam.
Cannot select steam setting/ flashing blue light remains on.	<ol style="list-style-type: none">1. If you have already plugged in your unit, unplug and try a different outlet. This may reset the mop.2. Add water to the tank and press the steam control button to select a steam setting.
Steam mop left white spot on the floor.	<ol style="list-style-type: none">1. Do not leave your steam mop on the floor with a damp or wet cleaning pad.2. Do you have hard water? If you do, it is strongly recommended to use distilled water.
Steam mop leaves water on the floor.	<ol style="list-style-type: none">1. Your cleaning pad might be too wet. Unplug your steam mop and change the microfiber cleaning pad.2. Wait 30 seconds to heat water to create steam. If water does not heat, water will be emitted instead of steam.
Floors are cloudy, streaky or spotty after steaming.	<ol style="list-style-type: none">1. The pad might be dirty, change the pad.2. If you washed the pad with powder detergent, then the pad may have residual detergent left on it. Wash it again with liquid detergent.3. If you are cleaning in a kitchen area where there might be a build-up of grease, use a de-greasing agent such as an all-purpose cleaner or dish soap and paper towels to clean the area first.4. You might have left the mop in the same spot for too long.5. Do you have hard water? If you do, you might want to switch to distilled water.6. This might be leftover from past cleaners used on the floor surface. Use the steam mop a few more times and see if the leftover cloudiness is removed.
Steam mop is hard to push.	<ol style="list-style-type: none">1. Make sure the cleaning pad is attached correctly.2. Check to see if the cleaning pad is excessively dirty. Replace if the pad is too dirty or wet.

Replacement Parts

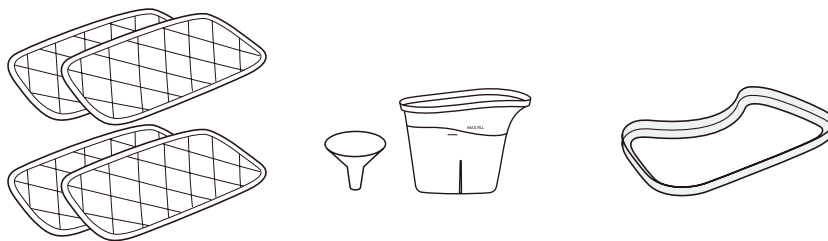

ORDERING REPLACEMENT PARTS

To order additional parts and accessories, feel free to contact us by visiting www.oceansales.com.

PART

1. Microfiber Pads
2. Filling Flask & Funnel
3. Carpet Glider

PART

Technical Parameter

Model	7623-1
Voltage	220 – 240V ~
Frequency	50Hz
Power	1550W
Water Tank	250ml

After Sales Returns Form – Guarantee Slip

If Your Appliance Requires Attention

1. First, check the operating instructions supplied to make sure the failure is not due to a problem you can rectify yourself.
2. If the appliance is still under warranty, contact the retailer, their details will appear on your receipt.

In order to enjoy the benefits of the one year guarantee, please retain your proof of purchase, ensuring that it shows the dates of purchase. Proof of purchase will be required within the guarantee period.

Model Number	_____
Name	_____
Address	_____
Postal Code	_____
Date of purchase	_____

PLEASE NOTE: Due to our continued development we reserve the right to alter product specifications.

MADE IN CHINA