



Coupé Neo

- ⓔ **User Manual**
- ⓓ **Betriebsanleitung**
- ⓕ **Instructions d'utilisation**
- ⓔ **Instrucciones de manejo**
- ⓓ **Instruções de operação**
- ⓓ **Istruzioni sull'uso**
- ⓓ **Gebruiksaanwijzing**
- ⓓ **Instruktionsbok**
- ⓓ **Instruksjonsbok**
- ⓓ **Instruktionsbog**
- ⓕ **Käyttöohje**
- ⓓ **用户手册**



CE

Coupé Neo

EN

DE

FR

ES

PT

IT

NL

SV

NO

DA

FI

ZH

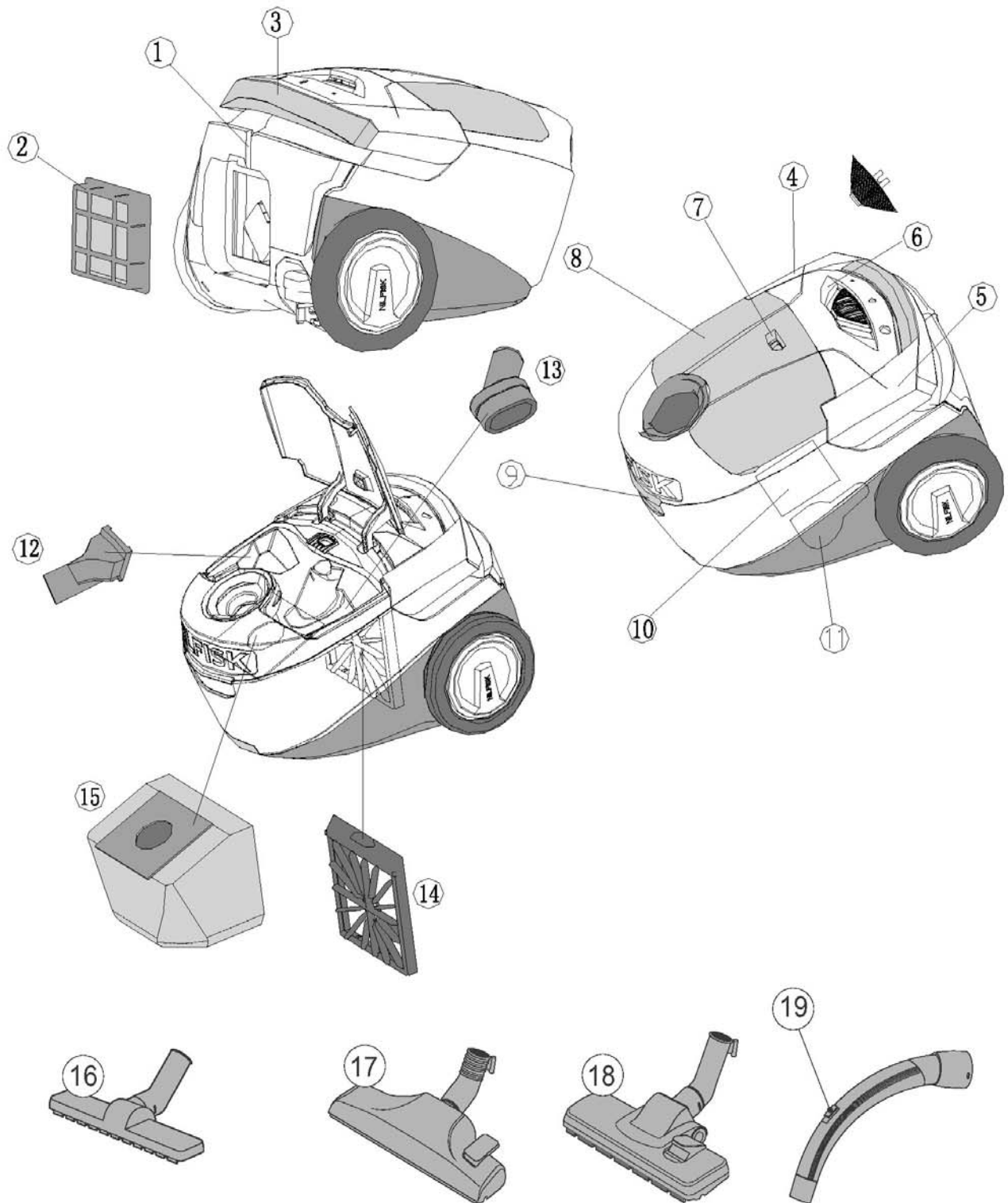

WEEE	4-5	EN
English	6	DE
Deutsch	14	FR
Français	22	ES
Español	30	PT
Português	38	IT
Italiano	46	NL
Nederlands	54	SV
Svenska	62	NO
Norsk	70	DA
Dansk	78	FI
Suomi	86	ZH
中国	94	

EN

DE

FR

ES

PT

IT

NL

SV

NO

DA

FI

ZH

WEEE - Waste of Electric and Electronic Equipment



English

The symbol  on the product or on its packing indicates that this product may not be treated as household waste. Instead it shall be handed over to the applicable collection point for the recycling of electrical and electronic equipment. By ensuring this product is disposed of correctly, you will help prevent potential negative consequences for the environment and human health, which could otherwise be caused by inappropriate waste handling of this product. For more detailed information about recycling of this product, please contact your local city office, your household waste disposal service or the shop where you purchased the product.



Deutsch

Das Symbol  auf dem Produkt bzw. auf der Produktverpackung deutet an, dass das Produkt nicht mit dem Haushaltsmüll entsorgt werden darf. Stattdessen ist es zur Entsorgung an eine geeignete Sammelstelle für das Recycling von elektrischen und elektronischen Geräten zu bringen. Durch die korrekte Entsorgung helfen Sie mit, potenziellen negativen Einflüssen auf die Umwelt und die Gesundheit vorzubeugen, die durch eine unangemessene Entsorgung dieses Produkts entstehen könnten. Genauere Informationen zur Wiederverwertung dieses Produkts erhalten Sie von Ihrer Stadtverwaltung, der Müllabfuhr vor Ort oder dem Geschäft, in dem Sie dieses Produkt erworben haben.



Français

Le symbole  sur le produit ou sur son emballage indique que ce produit ne doit pas être traité comme un déchet ménager. Il doit au contraire être remis au point de collecte correspondant pour le recyclage du matériel électrique et électronique. En procédant de cette manière, vous aiderez à prévenir les conséquences potentiellement négatives pour l'environnement et la santé humaine que pourrait causer un traitement inadéquat du rejet de ce produit. Pour plus ample information sur le recyclage de ce produit, veuillez prendre contact avec votre bureau municipal, votre service de collecte de déchets ménagers ou le magasin où vous avez acheté le produit.



Español

El símbolo  que aparece en el producto o en su embalaje indica que este producto no puede ser tratado como residuo doméstico. En su lugar, debe ser entregado en el correspondiente punto de recogida para el reciclado de equipos eléctricos y electrónicos. Al garantizar la adecuada eliminación de este producto, ayudará a evitar las posibles consecuencias negativas para el medio ambiente y la salud de las personas que se producirían a causa de una inadecuada manipulación de los residuos de este producto. Para obtener información más detallada acerca del reciclaje de este producto, póngase en contacto con la oficina local de su ciudad, el servicio de recogida de residuos domésticos o el establecimiento en el que ha adquirido el producto.



Português

Símbolo  no produto ou na embalagem indica que esse produto não deve ser tratado como um resíduo doméstico. Ao contrário, deve ser levado ao local de recolha adequado para a reciclagem de equipamentos electroelectrónicos. Ao se assegurar que o tratamento deste equipamento foi adequado, estará a ajudar a prevenir consequências potenciais ao meio ambiente e à saúde humana que poderiam ser causadas pelo manejo inapropriado do produto. Para mais informações sobre a reciclagem deste produto, entre em contacto com as autoridades locais, com o órgão responsável pela recolha de lixo ou a loja onde o produto foi adquirido.



Italiano

Il simbolo  sul prodotto o sulla confezione indica che questo prodotto non può essere smaltito fra i rifiuti domestici. Deve invece essere consegnato a un centro di raccolta autorizzato per il riciclaggio dei dispositivi elettrici ed elettronici. Smaltendo questo prodotto in modo corretto, si contribuisce a ridurre l'impatto ambientale e sull'uomo. Per maggiori informazioni sul riciclaggio di questo prodotto, contattare il proprio comune, il centro di raccolta dei rifiuti urbani locale o il rivenditore.

WEEE - Waste of Electric and Electronic Equipment



Nederlands

Het symbool  op het product of de verpakking geeft aan dat dit product niet als huishoudelijk afval mag worden behandeld. Het apparaat moet bij een verzamelpunt voor het recyclen van elektrische en elektronische apparatuur worden ingeleverd. Door dit product op de juiste manier af te danken, helpt u bij het voorkomen van mogelijke negatieve consequenties voor het milieu en de menselijke gezondheid. Deze zouden kunnen ontstaan als dit product niet op de juiste manier wordt behandeld. Voor uitgebreide informatie over het recyclen van dit product kunt u contact opnemen met uw plaatselijke stads-kantoor, uw afvalverwerkingsdienst of de winkel waar u het product hebt gekocht.



Svenska

Symbolen  på produkten eller emballaget anger att produkten inte får hanteras som hushållsavfall. Den skall i stället lämnas in på uppsamlingsplats för återvinning av el- och elektronikkomponenter. Genom att säkerställa att produkten hanteras på rätt sätt bidrar du till att förebygga eventuellt negativa miljö- och hälsoeffekter som kan uppstå om produkten kasseras som vanligt avfall. För ytterligare upplysningar om återvinning bör du kontakta lokala myndigheter, sophämtningstjänst eller affären där du köpte varan.



Norsk

Symbolet  på produktet eller emballasjen indikerer at dette produktet ikke kan behandles som husholdningsavfall. I stedet skal det leveres til aktuelt innsamlingspunkt for resirkulering av elektrisk og elektronisk utstyr. Ved å sørge for at dette produktet kasseres korrekt, bidrar du til å forebygge mulige negative følger for miljøet og folks helse, hvilket ellers kan forårsakes ved feilaktig avfallshåndtering av dette produktet. For nærmere informasjon om resirkulering av dette produktet, vennligst kontakt din lokale representant, renholdsverket eller butikken der du kjøpte produktet.



Dansk

Symbolet,  som findes på produktet eller emballagen, viser, at produktet ikke må bortskaffes sammen med almindeligt husholdningsaffald. Det skal derimod afleveres på en miljøstation, som er godkendt til håndtering af elektrisk og elektronisk udstyr. Sørg for at bortskaffe produktet korrekt, så du kan være med til at forebygge skader på miljøet og menneskers sundhed. Hvis du ønsker yderligere oplysninger om, hvordan produktet genvindes, kan du henvende dig hos kommunen, en miljøstation eller forretningen, hvor du købte produktet.

Suomi



Tuotteessa tai pakkauksessa oleva symboli ilmaisee, että tuotetta ei voi hävittää talousjätteen mukana. Sen sijaan tuote on vietävä sähköisten ja elektronisten laitteiden kierrätykseen tarkoitettuun keräyspisteeseen. Kun huolehdit tuotteen asianmukaisesta hävittämisestä, autat edistämään ympäristön ja ihmisten hyvinvointia, jonka tuotteen virheellinen hävittäminen voi vaarantaa. Lisätietoa tämän tuotteen kierrättämisestä saat jätteenkäsittelypisteistä tai samasta liikkeestä, josta ostit tuotteen.



此符  号在产品或者包装上指明此产品将不被视为家庭废弃物处理。取而代之的是它将移至电气和电子设备回收点回收。通过产品的正确回收处理，你将有助于防止由产品处理不当引起的对环境和人类健康产生的负面影响。更多关于回收本产品的详细信息，请联系当地有关政府办事处，你的家庭垃圾处理服务机构或者产品经销处。

EN

DE

FR

ES

PT

IT

NL

SV

NO

DA

FI

ZH

EN

DE

FR

ES

PT

IT

NL

SV

NO

DA

FI

ZH

Welcome!

Thank you for choosing the
Nilfisk Coupé vacuum cleaner

Overview

- 1 Parking bracket
- 2 HEPA filter
- 3 Handle
- 4 Cable rewriter
- 5 On/off button
- 6 Power level
- 7 Dust bag indicator, mechanical
- 8 Accessory lid
- 9 Open/close button, dust container
- 10 Rating plate
- 11 Parking bracket
- 12 Upholstery nozzle
- 13 Brush nozzle
- 14 Prefilter
- 15 Dust bag
- 16 Hard floor nozzle
- 17/18 Combination nozzle
- 19 Sliding valve
- 22 Bent tube
- 23 Exhaust grill

Table of contents

Overview	6
Display symbols	6
Safety instructions	7
Instructions for use	8
Cleaning tips	10
Trouble shooting	11
Service and maintenance etc.	11
Guarantee and service	11
Declaration of conformity	13

Display symbols



The dust bag is full and needs to be changed when the indicator is completely red.

Safety instructions

- Do not use the machine without dust bag and filters properly fitted.
- This machine is not intended for the suction of hazardous materials or gas, doing so may expose people to serious health risks.
- The machine must not be used for the suction of water or other liquids.
- Do not pick up sharp objects such as needles or pieces of glass.
- Do not pick up anything that is burning or smoking such as cigarettes, matches or hot ashes.
- Use and store this machine indoors and in a dry environment, 0 °C to 60 °C.
- Do not use the machine outdoors.
- Do not handle the machine with wet hands.
- Turn off the machine before unplugging.
- To unplug, grasp the plug, not by pulling on the cord. Do not carry or pull the machine by the cord.
- The machine must not be used if the cord shows any sign of damage. Regularly inspect the cord for damage, in particular if it has been crushed, shut in a door or run over.
- Do not use the machine if it appears faulty. Have the machine inspected by an authorized service center if the machine has been dropped, damaged, left outdoors or has been exposed to water.
- No changes or modifications to the mechanical or electrical safety devices should be made.
- All repairs must be carried out by an authorized service center.
- Use only original dust bags, original filters and original accessories from your local dealer. Use of unauthorized dust bags and filters will void the warranty.
- Turn off the machine and unplug before starting dust bag or filter change, grasp the plug, not by pulling on the cord.
- This appliance can be used by children aged from 8 years and above and persons with reduced physical, sensory or mental capabilities or lack of experience and knowledge if they have been given supervision or instruction concerning use of the appliance in a safe way and understand the hazards involved.
- Children shall be supervised to make sure that they do not play with the appliance.
- Cleaning and user maintenance shall not be made by children without supervision.
- If the supply cord is damaged, it must be replaced by the manufacturer or its service agent or similiary qualified person in order to avoid a hazard.

EN

DE

FR

ES

PT

IT

NL

SV

NO

DA

FI

ZH

EN

Instructions for use

DE

Before using the machine make sure that the voltage shown on the rating plate underneath the machine corresponds with the mains voltage.

FR

ES

PT

Start and stop

Start

Pull out the cord and plug the machine to a wall socket.

IT

NL

On/off button and power level.

SV

Stop

Turn off the machine and unplug. Unplug by grasping the plug, not by pulling on the cord.

NO

DA

FI

1 Connecting hose, tube and nozzles

ZH

1. Insert the hose connector into the suction inlet.
2. Connect the bent tube to the tube.
3. Connect the tube to the nozzle.
4. The tube is telescopic and can be adjusted to your height. Push the adjusting button to extend the tube, and pull back to shorten, to desired length.

Change of dust bag and filters

The size and quality of the dust bag and filters affect the machine efficiency. Use of non original dust bags or non original filters can cause restricted air flow which may lead to machine overload. Using non-original dust bag or filters will void the warranty.

2 Changing the dust bag

The dust bag indicator turns completely red when the dust bag needs to be changed.

Always use original dust bags.

3 Changing the prefilter

The prefilter protects the motor by absorbing micro-particles that the dust bag can not keep. Change the prefilter with every fifth dust bag. The prefilter is located behind the dust bag. Always use original filters.

4 Changing the HEPA filter

The HEPA filter cleans the exhaust air from micro particles the dust bag can not keep. The HEPA filter can not be brushed or washed clean if not mentioned.

Washable HEPA filter

Some models have washable HEPA filter.

Rinse the inside of the filter using lukewarm tap water. Do not use any cleaning agents and avoid touching the filter surface. Tap the filter frame to remove the water.

Do not use an external heat source, e.g. a radiator or direct sunlight to dry the filter.

Make sure to let the filter dry before putting it back into the vacuum cleaner.

Adjust the suction power

Sliding valve on the bent tube

The suction power is maximal with the sliding valve closed and minimal when all open. Adjust the suction power by putting the sliding valve in the desired position.

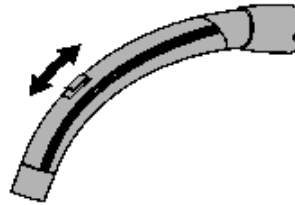

Power regulation

The suction power is adjusted with slider on the machine.



5 Parking the tube and nozzle

There are two grooves for parking. One located on the underside to use when machine stands on the back, and the other on the back to use when the machine is standing on its wheels.

EN

DE

FR

ES

PT

IT

NL

SV

NO

DA

FI

ZH

EN

Thermal fuse

The machine is fitted with a thermal fuse, which prevents the machine from overheating. If the thermal fuse blows, the machine automatically switches off the motor and must cool before it can be started again.

DE

FR

ES

PT

IT

NL

SV

NO

DA

FI

ZH

Restart

1. Turn off the machine and unplug from the wall socket.
2. See to that nothing blocks the air flow through the bent tube, hose, tube, nozzle, dust bag or filters.
3. Let the machine cool.
4. Plug in the machine again and push the start button. The machine will not start until cool enough. If the machine does not start turn it off and unplug. Try again in a while.

Cleaning tips

Adjust the suction power by means of the power regulation or the sliding valve on the bent tube.

6 Upholstery nozzle

Use the upholstery nozzle for upholstered furniture.

7 Brush nozzle

Use the brush nozzle for curtains and window sills.

8 Hard floor nozzle

Use the nozzle for hard floors.

9 Combination nozzle

Adjust the combination nozzle depending on type of floor.

10 Turbo nozzle

Use the turbo nozzle for efficient carpet cleaning.

The models can include different nozzles.

Trouble shooting

Repair or service of electrical components such as cord or motor, must only be carried out by an authorized service center.

If the machine does not start	Check that the plug is correctly fitted to the wall socket.
	A fuse in the building may have blown and needs to be changed.
	The cord or plug may be damaged and must be repaired by an authorized service center.
Reduced suction power	The dust bag may be full and needs to be changed, see instructions.
	The prefilter, HEPA filter can be blocked and have to be changed, see instructions.
	The bent tube, hose, tube or nozzle may be blocked and needs to be cleaned.
If the machine stops	The thermal fuse may have blown, see instructions.

Service and maintenance

- Store the machine indoors and in a dry environment.
- Change the prefilter with every fifth dust bag. The dust bag package includes five dust bags and one prefilter.
- Clean the machine surface with a dry cloth or a damp cloth with a little cleaning agent.
- Order original accessories from a local dealer.
- Service – contact your local dealer.

Recycling and scrapping

Recycle the wrapping and scrap the machine according to recommendations from the local authorities. Cut the cord as short as possible to avoid someone getting injured on the scrapped machine.

Environmental commitment

This machine is designed with the environment in mind. All plastic parts due marked for recycling.

Responsibility

Nilfisk disclaim all responsibility for all damage caused by incorrect use or modification of the machine.

Guarantee

The warranty can vary between different countries. Contact your local dealer for information.

Guarantee and service

This Nilfisk Coupé Series vacuum cleaner is covered by a two (2) year guarantee on the machine, which covers the motor, cable rewinder, switch and casing. The nozzles, filters, hoses, tubes and other accessories are covered twelve months due to manufacturing fault only and excludes wear and tear.

EN

DE

FR

ES

PT

IT

NL

SV

NO

DA

FI

ZH

EN

The guarantee includes spare parts and labour costs, and covers manufacturing and material defects that may occur during normal domestic use.

DE

Service under the guarantee will only be performed if it can be proven that the defect occurred within the product's guarantee period (a correctly completed guarantee certificate or printed/stamped cash register receipt with date and product type) and on the condition that the vacuum cleaner was bought as a new product and distributed by Nilfisk-Advance.

FR

In the event of the repair of defects, the customer must contact Nilfisk-Advance to be directed to a service agent at the customer's own expense. Upon completion of any repairs necessary, the vacuum cleaner will be returned to the customer at the risk and expense of Nilfisk-Advance.

ES

PT

IT

NL

SV

NO

DA

FI

ZH

The guarantee does not cover:

- Normal wear and tear of accessories and filters.
- Defects or damage occurring as a direct or indirect result of incorrect use - such as the vacuuming of rubble, hot ashes or carpet deodorant powder.
- Abuse, loss or lack of maintenance as described in *User Manual*.
- If the machine has been used for home renovations.
- If the machine has been used for suction of water, plaster dust or sawdust.

Nor will it cover incorrect or poor configuration, i.e. setting up or connection, nor fire-damage, fire, lightning strike or unusual voltage fluctuations or any other electrical disturbances such as defective fuses or defective electrical installations on the supply grid, and defects or damage in general that Nilfisk-Advance consider to be the result of causes other than manufacturing and material defects.

The guarantee becomes void:

- If a defect is caused by the use of non-original Nilfisk dust bags and filters.
- If the identity number is removed from the vacuum cleaner.
- If the vacuum cleaner has been repaired by a non-Nilfisk authorized dealer.
- If the machine is used in a commercial environment, i.e. building contractors, cleaning contractors, professional trades or any other non-domestic usage.

The guarantee is valid in:

Denmark, Sweden, Norway, Great Britain, Ireland, Belgium, Holland, France, Germany, Poland, Russia, Austria, Switzerland, Spain, Portugal, Australia and New Zealand, Estonia, Latvia, Lithuania, Hungary, Greece, Slovenia, Slovakia, The Czech Republic, Italy, Finland, Bulgaria, Romania and Turkey.

Addendum Australia:

Our goods come with guarantees that cannot be excluded under the Australian Consumer Law. You are entitled to a replacement or refund for a major failure and for compensation for any other reasonably foreseeable loss or damage. You are also entitled to have the goods repaired or replaced if the goods fail to be of acceptable quality and the failure does not amount to a major failure.

Nilfisk vacuum cleaners for domestic use are warranted for 2 years from the date of purchase by:

Nilfisk-Advance Pty Ltd
Unit 1/13 Bessemer Street
Blacktown NSW 2148
Phone: 1300 556 710
E-mail: sales@nilfisk.com.au

Find your local service agent here:
<http://www.nilfisk.com.au>.

The benefits under this warranty are in addition to your national law of sale.

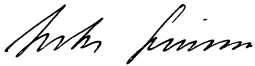
 Declaration of Conformity	
Product:	Vacuum Cleaner
Type:	Nilfisk Coupé Neo
The design of the unit corresponds to the following pertinent regulations:	EC Low-voltage Directive 2006/95/EC EC EMC Directive 2004/108/EC RoHS Directive 2011/65/EC
Applied harmonised standards:	EN 60335-1:2002+A14:2010 EN 60335-2-2:2010 EN 62233:2008 EN 55014-1:2006+A1:2009 EN 55014-2:1997+A2:2008 EN 61000-3-2:2006+A2:2009 EN 61000-3-3:2008
Applied national standards and technical specifications:	IEC 60335-2-2:2009 IEC 60335-1:2001(2002)+A1:2004+A2:2006
Name and address of the person authorised to compile the technical file:	Anton Sørensen General Manager, Technical Operations EAPC Nilfisk-Advance A/S Sognevej 25 DK-2605 Brøndby
Identity and signature of the person empowered to draw up the declaration on behalf of the manufacturer:	 Anton Sørensen General Manager, Technical Operations EAPC Nilfisk-Advance A/S Sognevej 25 DK-2605 Brøndby
Place and date of the declaration	Hadsund, 13.03.2013

EN

DE

FR

ES

PT

IT

NL

SV

NO

DA

FI

ZH

- EN
- DE
- FR
- ES
- PT
- IT
- NL
- SV
- NO
- DA
- FI
- ZH

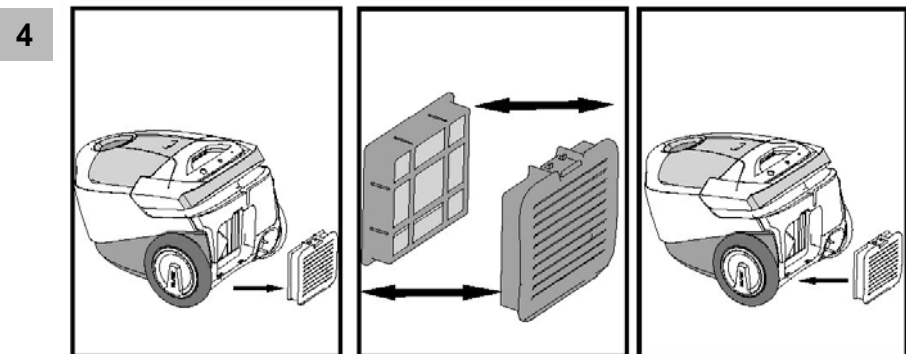
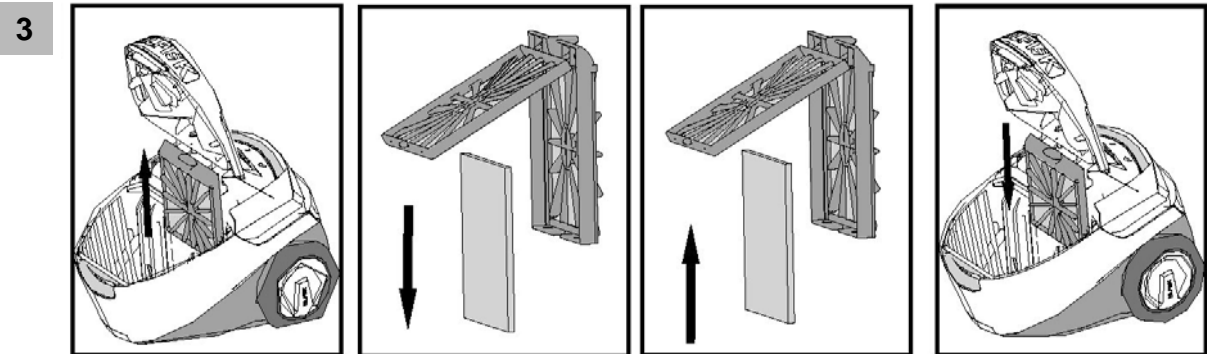
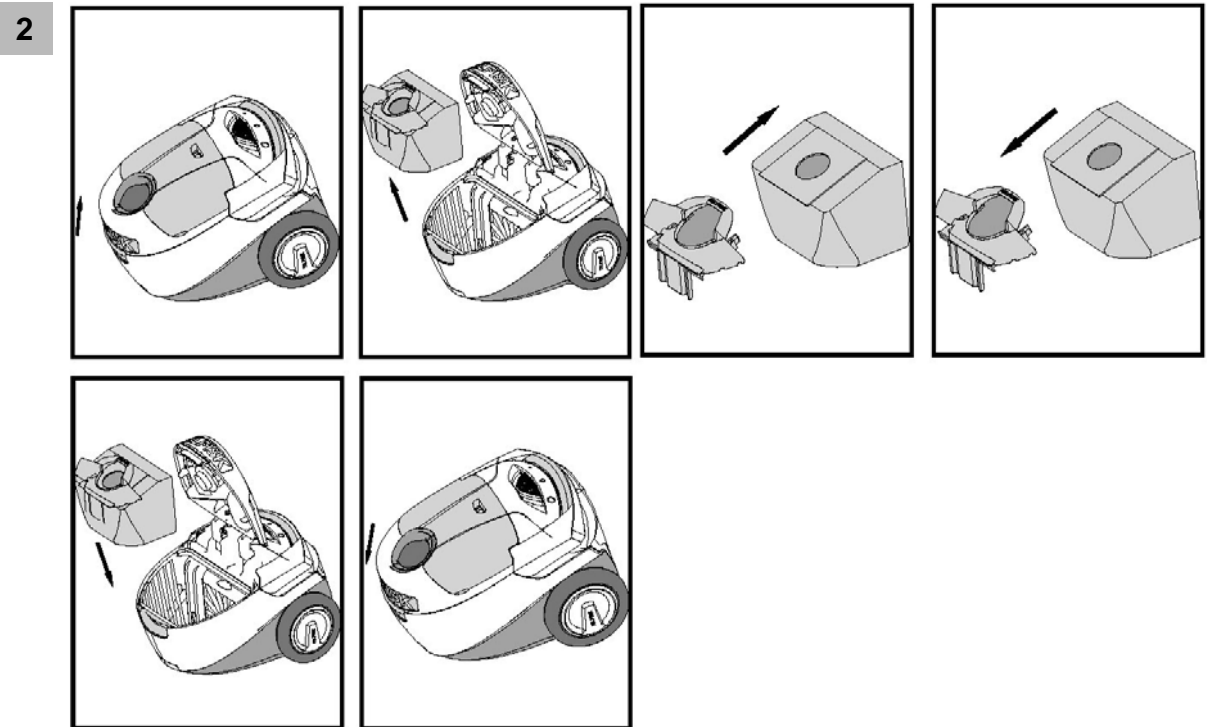
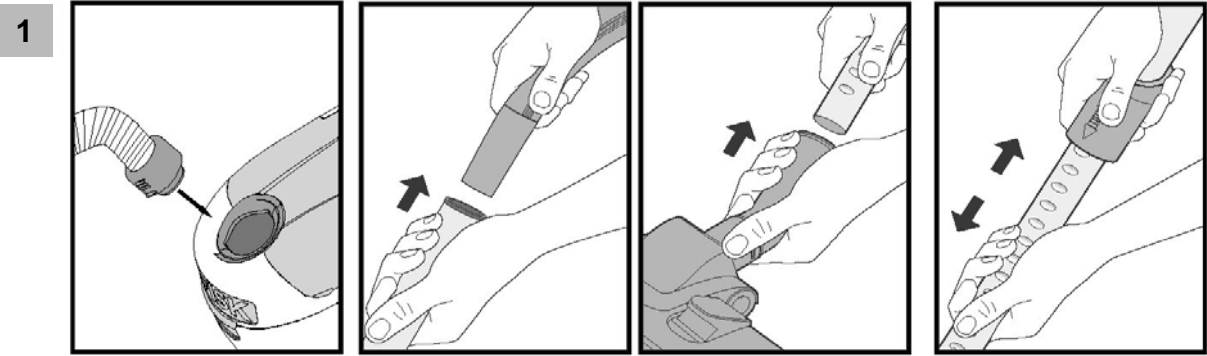

5

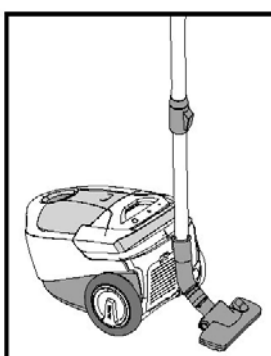
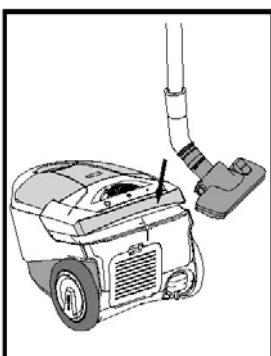
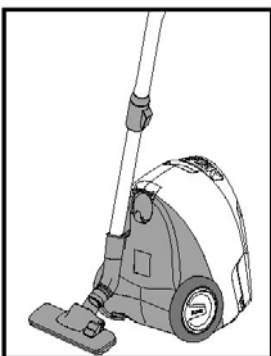
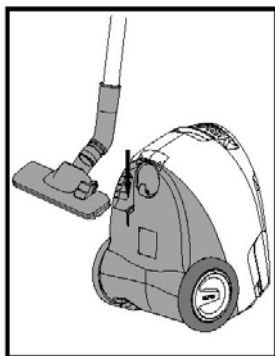

6

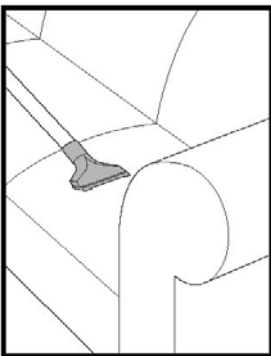

7

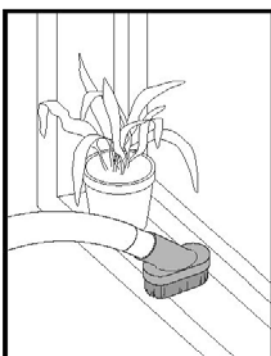
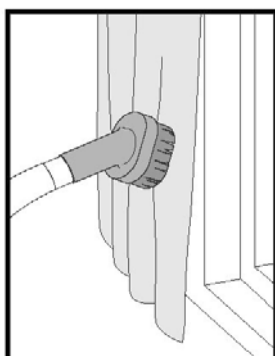

8

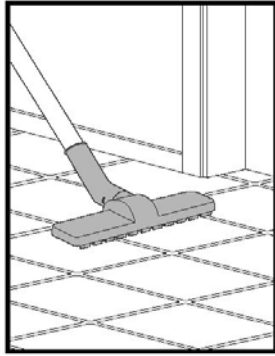

9

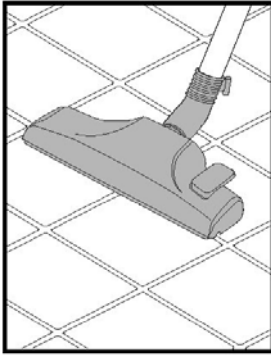

10

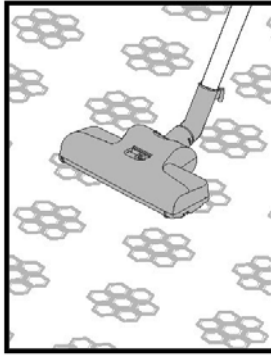

- EN
- DE
- FR
- ES
- PT
- IT
- NL
- SV
- NO
- DA
- FI
- ZH



trusted since 1906

Web: <http://www.nilfisk.com>

HEAD QUARTER

DENMARK

Nilfisk-Advance Group
Sognevej 25
DK-2605 Brøndby
Tel.: (+45) 4323 8100
E-mail: kundeservice.dk@nilfisk.com

SALES COMPANIES

AUSTRALIA

Nilfisk-Advance Pty. Ltd.
1/13 Bessemer Street
Blacktown NSW 2148
Tel.: 1300 556 710
Web: <http://www.nilfisk.com.au/>

AUSTRIA

Geschäftsbereich der Nilfisk Advance GmbH
Metzgerstrasse 68
A-5101 Bergheim/Salzburg
Tel.: +43 (0) 662 45 64 00 90
E-mail: info.at@nilfisk.com
Web: <http://www.consumer.nilfisk.at>

BELGIUM

Nilfisk-Advance NV/SA.
Riverside Business Park
Boulevard Internationale 55
Bruxelles 1070
Tel.: +32 14 67 60 50
Web: <http://www.nilfisk.be>

CHILE

Nilfisk-Advance de Chile
San Alfonso 1462
Santiago
Tel.: (+56) 2 684 5000
E-mail: Pablo.Noriega@nilfisk.com

CHINA

Nilfisk-Advance Cleaning Equipment (Shanghai) Ltd.
No. 4189 Yindu Road
Xinzhuang Industrial Park
Shanghai 201108
Tel.: +86 21 3323 2000
E-mail: info.sha-cn@nilfisk.com
Web: <http://www.nilfisk.cn>

CZECH REPUBLIC

Nilfisk-Advance s.r.o.
VGP Park Horní Pocerne
Budova H2, Do Certous 1
Praha 190 00
Tel.: +420 244 090 912
E-mail: info@nilfisk.cz
Web: <http://www.nilfisk.cz>

DENMARK

Nilfisk-Advance NORDIC A/S
Sognevej 25
2605 Brøndby
Tel.: (+45) 4323 4050
E-mail: kundeservice.dk@nilfisk.com

FINLAND

Nilfisk-Advance Oy Ab
Koskelontie 23E
02920 Espoo
Tel.: +358 207 890 600
Web: <http://www.nilfisk.fi>

FRANCE

Nilfisk-Advance
26 Avenue de la Baltique
Villebon sur Yvette
91944 Courtaboeuf Cedex
Tel.: 169 59 87 24
E-mail: info.fr.@nilfisk-advance.fr
Web: <http://www.nilfisk.fr>

GERMANY

Nilfisk-ALTO
Guido-Oberdorfer-Strasse 10
89287 Bellenberg
Tel.: +49 7306 72-0
E-mail: info-consumer.de@nilfisk.com
Web: <http://www.nilfisk.de>

GREECE

Nilfisk-Advance A.E.

Αναπαύσεως 29

19400 Κορωπί
Tel.: +30 210 9119 600
E-mail: mail.gr@nilfisk.com
Web: <http://www.nilfisk.gr>

HOLLAND

Nilfisk-Advance
Versterkerstraat 5
1322 AN Almere
Tel.: +31 365 460 700
E-mail: info.nl.@nilfisk.com
Web: <http://www.nilfisk.nl>

HONG KONG

Nilfisk-Advance Ltd.
Room 2001 HK Worsted Mills
Industrial Building
31-39 Wo Tong Tsui Street
Kwai Chung, NT
Tel.: +852 2427 5951

HUNGARY

Nilfisk-Advance Kereskedelmi Kft.
H-2310 Szigetszentmiklós
Lakihegy, II. Rákóczi Ferenc út 10
Tel.: +36 24 507 450
Web: <http://www.nilfisk.hu>

INDIA

Nilfisk-Advance India Limited
Pramukh Plaza, "B" Wing, 4th floor
Unit No. 403
Cardinal Gracious Road
Chakala, Andheri (East)
Mumbai - 400 099
Tel.: +91 22 61188199

IRELAND

Nilfisk-Advance
1 Stokes Place
St. Stephen's Green
Dublin 2
Tel.: +35 3 12 94 38 38

ITALY

Nilfisk-Advance SpA
Strada Comunale della Braglia, 18
26862 Guardamiglio (LO)
Tel.: +39 0377 41 40 31
Web: <http://www.nilfisk.it>

JAPAN

Nilfisk-Advance Inc.
1-6-6 Kita-shinyokohama, Kouhoku-ku
Yokohama, 223-0059
Tel.: +81 45 548 2571

MALAYSIA

Nilfisk-Advance Sdn Bhd
Sd 14, Jalan KIP 11
Taman Perindustrian KIP
Sri Damansara
52200 Kuala Lumpur
Tel.: +60 3603 627 43 120

MEXICO

Nilfisk-Advance de Mexico, S. de R.L. de C.V.
Agustín M. Chavez No. 1, PB oficina 004
Col. Centro de Ciudad Santa Fe
01210 Mexico, D.F.
Tel.: +52 55 2591 1002 (switchboard)
E-mail: info@advance-mx.com

NEW ZEALAND

Nilfisk-Advance Limited
Danish House
6 Rockridge Avenue
Penrose, Auckland 1135
Tel.: +64 9525 3890
Web: <http://nilfisk.com.au>

NORWAY

Nilfisk-Advance AS
Bjørnerudveien 24
1266 Oslo
Tel.: +47 22 75 17 80
Web: <http://www.nilfisk.no>

POLAND

Nilfisk-Advance Sp. z o.o.
Millenium Logistic Park
ul. 3-go Maja 8, Bud. B4
05-800 Pruszków
Tel.: +48 22 738 3750
E-mail: biuro@nilfisk.pl
Web: <http://www.nilfisk.pl>

PORTUGAL

Nilfisk-Advance
Sintra Business Park
Zona Industrial Da Abrunheira

Edificio 1, 1º A
P2710-089 Sintra
Tel.: +351 21 911 2670
Web: <http://www.nilfisk.pt>

RUSSIA

Нилфиск-Эдванс
127015 Москва
Вятская ул. 27, стр. 7
Россия
Tel.: +7 495 783 9602
E-mail: info@nilfisk.ru
Web: <http://www.nilfisk.ru>

SOUTH KOREA

Nilfisk-Advance Korea
3F Duksoo B/D, 317-15
Sungsoo-Dong 2Ga, Sungdong-Gu,
Seoul
Tel.: +82 2497 8636

SOUTH AFRICA

WAP South Africa (Pty) Ltd
12 Newton Street
1620 Spartan, Kempton Park
Tel.: +27 11 975-7060
E-mail: mhenstock@wap.co.za
Web: <http://www.wap.co.za>

SPAIN

Nilfisk-Advance S.A.
Torre D'Ara
Paseo del Rengle, 5 Pl. 10
08302 Mataró
Tel.: +34 93 741 2400
E-mail: mkt.es@nilfisk.com
Web: <http://www.nilfisk.es>

SWEDEN

Nilfisk-ALTO Sverige AB
Aminogatan 18
431 04Mölnådal
Tel.: +46 31 706 73 00
E-mail: info.se@nilfisk.com
Web: <http://www.nilfisk.se>

SWITZERLAND

Nilfisk-Advance AG
Ringstrasse 19
Kirchberg/Industrie Stelz
9500 Wil
Tel.: +41 71 92 38 444
Web: <http://www.nilfisk.ch>

TAIWAN

Nilfisk-Advance
Taiwan Branch (H.K.)
No. 5, Wan Fang Road
Taipei
Tel.: +886 2 22398812
Web: <http://www.nilfisk-advance.com.tw>

THAILAND

Nilfisk-Advance Co. Ltd.
89 Soi Chokechai-Ruammitr
Viphavadee-Rangsit Road
Ladyao, Jatuchak, Bangkok 10900
Tel.: +66 2275 5630

TURKEY

Nilfisk-Advance A.S.
Serifali Mh. Bayraktar Bulv.
Şehit Sk. No: 7
Ümraniye
İstanbul
Tel.: +90 216 466 94 94
E-mail: info.tr@nilfisk-advance.com
Web: <http://www.nilfisk.com.tr>

UNITED KINGDOM

Nilfisk (A Division of Nilfisk-Advance Ltd.)
Bowerbank Way
Gilwilly Industrial Estate, Penrith
Cumbria CA11 9BQ
Tel: 01768 868995
Web: <http://www.nilfisk.co.uk>

UNITED ARAB EMIRATES

Nilfisk-Advance Middle East Branch
SAIF-Zone
P.O. Box 122298
Sharjah
Tel.: +971 (0) 655 78813

VIETNAM

Nilfisk-Advance Representative Office
No. 51 Doc Ngu Str.
Ba Dinh Dist.
Hanoi
Tel.: +84 904266368
E-mail: nilfisk@vnn.vn